



— Stock Code: 688026 —

YOUR RELIABLE PARTNER IN LIFE SCIENCE

CATALOGUE

Guangzhou Jet Bio-Filtration Co.,Ltd.

Address: No. 1 Dechang Road, Yonghe Development Zone, Guangzhou, 511256, China
Contact Number: +86-400-0217-688
Pre-sale service: info@jetbiofil.com
After-sale service: info@jetbiofil.com



— Stock Code: 688026 —

ENRICO BRUNO s.r.l.
 APPARECCHI SCIENTIFICI
 SANITARI - INDUSTRIALI
www.enrico-bruno.it

ENRICO BRUNO s.r.l.
 APPARECCHI SCIENTIFICI
 SANITARI - INDUSTRIALI
www.enrico-bruno.it

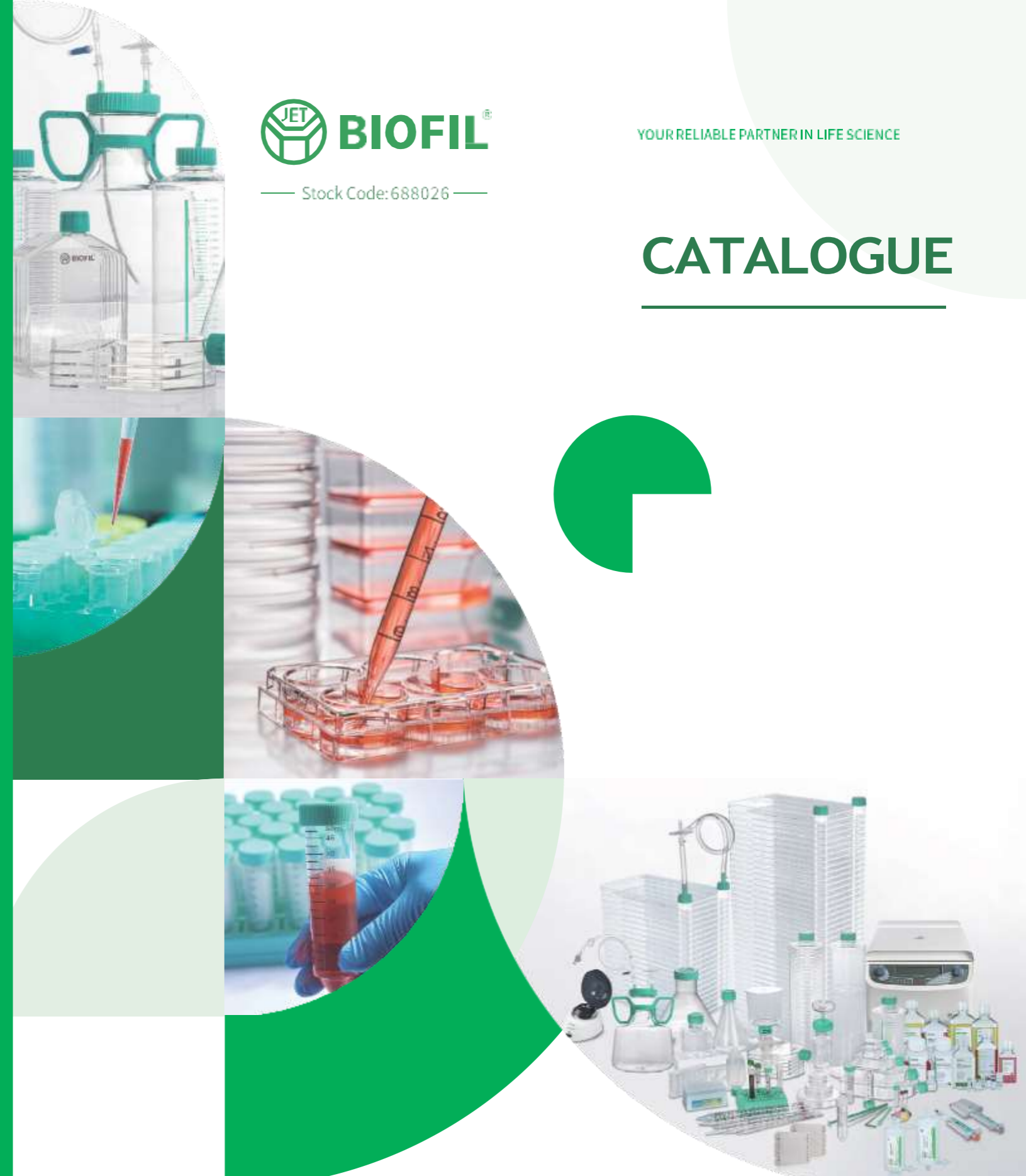

Guangzhou Jet Bio-Filtration Co.,Ltd.



Jet Biofil Achieves Silver Ranking in EcoVadis Sustainability Assessment

-- To Lead in Sustainable Development

- Top 15% of all involved enterprises in the evaluation of Four Themes



Guangzhou Jet Bio-Filtration Co., Ltd. Crafting Excellence Since 2001

Guangzhou Jet Bio-Filtration Co., Ltd. (stock code: 688026), founded in 2001 and located in the Huangpu District of Guangzhou City, is a domestically leading high-tech enterprise that offers total solutions for biological laboratories. The company boasts a total construction area of 490,000 m², including 40,000 m² of intelligent manufacturing workshops and over 65,000 m² of GMP Cleanrooms. Thousands of the company's products, including biological laboratory consumables, bioprocess consumables, biological reagents, and laboratory instruments, have been widely used in more than 70 countries and regions. The company owns several core technologies and advanced production processes for biological laboratory consumables and has been successfully selected into the global supply chain system for world-famous service providers of biological laboratory materials, by virtue of excellent technical performance, product quality, and efficient service.

Jet Biofil upholds an innovative spirit and focuses on strengthening the research and development of core technologies. The company currently holds 208 patents, including 37 invention patents, and has received the China Invention Patent Award for four consecutive years. Additionally, Jet Biofil has led the formulation of two provincial standards and 24 group standards, and participated in the development of one national standard and three industry standards.

On October 24, 2018, Guangzhou Jet Bio-Filtration Co., Ltd. was honorably inspected by General Secretary Xi Jinping on behalf of private enterprises.

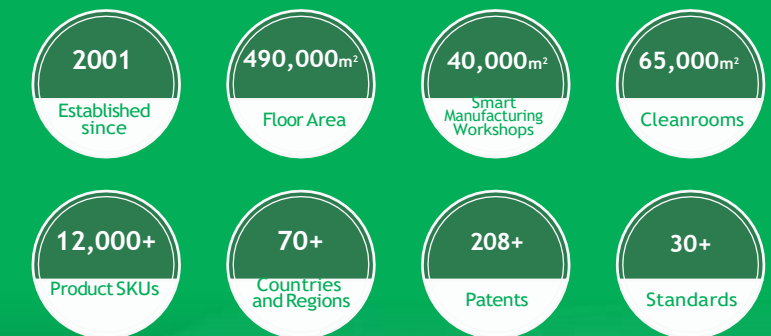

History

2020-2022 Go forward with honor

- Awarded the title of “an important contributor to the material support work of COVID-19 epidemic prevention and control in Guangdong Province”
- Included in the “Little Giant” list of national Professional, Specialized, Characteristic, and Original by the Ministry of Industry and Information Technology
- Grand commencement of Jet Life Science (Guangzhou) intelligent manufacturing and storage project



2018 Attract worldwide attention

- Mr. Yuan Jianhua, Chairman of the company, was received by the General Secretary Xi as a representative of private entrepreneurs

2020 Reach new heights

- Successfully listed on the Science and Technology Innovation Board of Shanghai Stock Exchange



2013-2018 Score big points

- Became the first batch of Guangzhou Development Zone pilot units of science and technology enterprise incubator
- Recognized as “Guangdong Engineering Technology Research Center for Disposable Biological Laboratory Supplies”
- The company’s R&D center was recognized as the provincial enterprise technology center



2001-2003 Fledgling

- Guangzhou Jet Bio-Filtration Co., Ltd. was established
- The first product was successfully developed by using high polymer material modification technology



2025 New Chapter Begins

- Jet Life Science (Guangzhou) intelligent manufacturing and storage project put into use



2023-2024 Pursue Greatness

- 160,000m² new plant in Guangzhou's Huangpu District now operational
- Four consecutive years as “China Patent Award” winner
- 30,000m² automated storage center in Zengcheng District launched



Quality Assurances

Over the past two decades, we have implemented multiple measures to ensure consistent product quality:

- ✓ Careful product design and precision manufacturing
- ✓ Selection of raw materials in accordance with USP Class VI standards
- ✓ High automation production in a cleanroom environment with a class 100,000 rating
- ✓ Certification compliance with ISO 13485/ISO 15378/ISO 9001/ISO 14001 standards
- ✓ FDA-approved enterprise (Registration number: 3011966385)
- ✓ Multiple CE certifications in the EU
- ✓ Laboratory is accredited by CNAS and certified by CMA
- ✓ Possession of a medical device production license
- ✓ Each product's minimum packaging is labeled with a batch number, facilitating accurate quality traceability



License of Medical Device Production



CMA



CNAS



ISO 9001



ISO 13485
(Medical Devices Quality management system)



ISO 15378
(Primary Packaging Materials for Medicinal Products)



ISO 14001



GMP Workshop Assessment

Quality Benchmarks

To ensure that your research attains the highest level of repeatability and reliability, our product quality undergoes continuous upgrades.



- ✓ Sterile
Complies with ISO 11137 standards, Sterility Assurance Level (SAL) < 10⁻⁶
- ✓ Pyrogen-free/Endotoxin-free < 0.03EU/mL
- ✓ Human DNA-free < 0.03pg/μL
- ✓ DNase-free < 1x10⁻⁶ Kunitz units
- ✓ RNase-free < 1x10⁻⁶ Kunitz units
- ✓ PCR Inhibitor-free ≤ 2 cycle shifts
- ✓ ATP-free < 2x10⁻¹² mg/μL

490,000 Square Meters of Intelligently Upgraded Manufacturing Facilities

 **Huangpu Manufacturing Plant: 160,000 m²**

 **Zengcheng Manufacturing Plant: 330,000 m²**

Jet Biofil currently operates two manufacturing plants in Huangpu and Zengcheng, with a total construction area of 490,000 m². These facilities include a 3,500 m² R&D center, a 3,000 m² testing center accredited by CNAS, a 30,000 m² storage center (featuring an 18,400 m² automated warehouse), and a 3,500 m² irradiation sterilization center. The company has also built a total of 65,000 m² of Class 100,000 GMP cleanrooms and 40,000 m² of intelligent manufacturing workshop, which have enhanced unmanned production and represent our commitment to establishing an industry-leading "Lighthouse Factory."



GMP Cleanrooms: 65,000 m²

Strictly adhering to GMP guidelines, we have created a rigorously sterile manufacturing environment to ensure high product cleanliness.



CNAS-accredited Testing Center: 3,000 m²

As an independent third-party testing institution under Jet Biofil, Jet Testing Technology Service has biochemistry, physicochemical, molecular, cell, and microbiology laboratories, enabling us to provide specialized, comprehensive, and authoritative testing and quality control services for biological laboratory consumables.



Intelligent Manufacturing Workshops: 40,000 m² (with MES)

By equipping advanced production equipment and implementing MES infrastructure, We have achieved a high level of automation and digital control, enabling minimal manual intervention throughout the production process. While improving efficiency, the overall product quality has significantly improved.



Irradiation Sterilization Center: 3,500 m²

Jet Biofil has established an independent irradiation sterilization center with 3,500 m² scale with integrated high-energy standing wave electron accelerator irradiation system, capable of an annual sterilization capacity of up to 800,000 m³. This setup enables seamless integration of production and sterilization processes.



Automated Warehouse with AS/RS: 18,400 m²

Jet Biofil's automated warehouse consists of 18,844 high-tier shelves, a computer-controlled management system and advanced equipment. Standing 31 meters tall, the warehouse achieves an annual handling capacity of 6.72 million units. These facilities seamlessly ensure real-time information sharing and supply chain connectivity, significantly enhancing storage and logistics efficiency while improving inventory control accuracy.

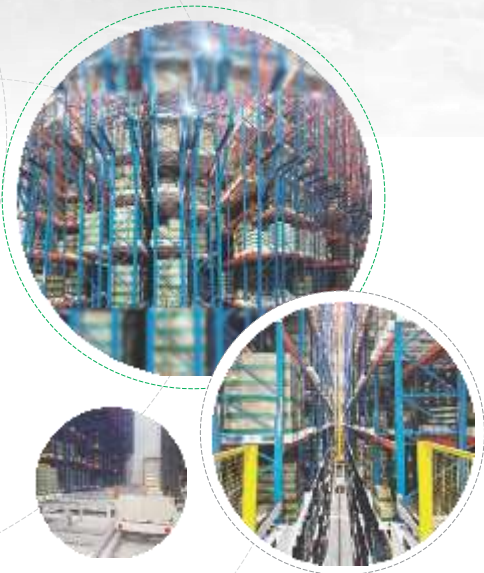

Intelligent Warehouse/Logistics Management System

In addition to the automated warehouse at our China headquarters, we have also established over 280 storage and logistics distribution points across various locations. By introducing the intelligent warehouse management system (WMS) and logistics management procedures, we have built an intelligent international and domestic storage/logistics distribution network. This allows us to achieve maximum coverage of goods and the most efficient allocation, ensuring meticulous services to all customers.



Global Business, Dedicated Service



Transnational Business

With outstanding technical performance, product quality, and efficient service, Jet Biofil's products are exported to over 70 countries and regions. We established long-term, friendly cooperative relationships with customers, including some of the world's top 500 companies in the field of life sciences. In recent years, Jet Biofil has established subsidiaries in Hong Kong SAR, China, the United States and Germany, further accelerating its journey toward internationalization journey.

Domestic Business

Jet Biofil's domestic business outlets span across China, with 12 offices established in key cities including Beijing, Xi'an, Changchun, Tianjin, Shanghai, Wuhan, Nanjing, Hangzhou, Guangzhou, Shenzhen, Chengdu, and Chongqing.



Contents

1 Biological Laboratory Consumables

Cell Culture

Cell and Tissue Culture Flasks	10
Cell and Tissue Culture Dishes	13
Cell and Tissue Culture Plates	15
New 96-well Solid Black/White Cell Culture Plates	17
CellATTACH® Cell and Tissue Culture Products	18
CellDETACH™ Temperature-Responsive Cell Culture Surface	19
New 3DSphearo™ Ultra-low Adsorption Surface	21
New Poly-D-Lysine-coated Products	22
Tissue Culture Plate Inserts	23
100 mm Tissue Culture Dish Inserts	25
Confocal Dishes	26
CellSLIP® Coverslips	27
CellSCAFOLD® 3D Cell Culture Scaffolds	28
New Specs Bio-Reaction Tubes	30
Culture Tubes	31
New Specs PS Centrifuge Tubes	32
New Specs Cell Strainers	33
New Small Cell Strainers	34
Pestles for Cell Strainer	35
Pestles for 1.5 mL Micro Centrifuge Tube	36
Rotatable Cell Scrapers	36
New Specs Cell Scrapers	37
Cell Blade and Lifters	38
L-shaped Cell Spreader	38
New Specs Cryogenic Vials	39

Liquid Handling and Storage

Centrifuge Tubes	48
Conical Centrifuge Bottles	50
High-Performance Centrifuge Tubes	51
Light Sensitive Centrifuge Tubes	51
High RCF Centrifuge Tubes	52
15 mL Centrifuge Tube with Puncture Hole	53
Metal-Free Centrifuge Tubes	53
EasyFlip™ Centrifuge Tubes	54
30 mL Self-standing Centrifuge Tubes	55
New Specs PBMC Separation Tubes	56
New Specs Plastic Centrifuge Tube Racks	57

Serum & Sample Tubes	59
Plastic Pasteur Pipets	60
Serological Pipets	61
Open End Pipets	64
Mini™ Serological Pipets	65
Aspirating Pipets	65
Milk Pipets	66
Disposable Sampling Tubes	67
Transfer Pipets	68
New Specs Square Media Bottles	69
Solution Bottles	70
New Reagent Bottles	71

Filtration

Syringe Filters	77
50 mm Syringe Filters	81
50 mm Sterilizing Filters	82
Vacuum Bottle Filters	83
Filter Upper Cups	86
Reservoir Bottles	89
Tube Vacuum Filters System	90
Tube Top Vacuum Filters	91
Upgraded JetSpin® Centrifugal Filters	92

Molecular Biology

Pipette Micro Tips	95
ZEROTIP® Pipette Micro Tips	100
Robotic Tips	103
Micro Centrifuge Tubes	108
Lid Lock Micro Centrifuge Tubes	110
EasyFlip™ 1.5 mL Micro Centrifuge Tubes	112
Low Binding Micro centrifuge Tubes (Lo-Protein™/Lo-DNA™)	113
Deep-well Plates	115
Sample Library Tubes	117
PCR Plates	119
PCR Tubes	120
PCR Plate Sealing Films	122

New Plasmid Maxiprep Purification Column	123
New Nucleic Acid Maxiprep Purification Column	124
Reagent Reservoirs(PP)	125
Reagent Reservoirs(PET/PS)	126
12-Channel Reagent Reservoir	127

CellSafe™ GMP-grade Life Science Consumables

CellSafe™ GMP-grade Life Science Consumables	129
--	-----

Others

ELISA Plates	133
Serological Plates	135
Immuno Micro Plates	135
Petri Dishes	136
New Partitioned Petri Dishes	138
New Contact Plate	138
Inoculating Loops and Needles	139
Cuvettes	140
Graduated Urine Centrifuge Tubes	141
Latex Powder-free Gloves	141
NBR Gloves	142

3 High-performance Membrane Materials

New PES Ultrafiltration Membranes	166
--	-----

5 Biological Reagents

Fetal Bovine Serum	172
Media	173
Insect Media	175
Supplementary Reagents	175

2 Bioprocess Consumables

Bioproduction Scaling-up

Upgraded CellFac® Multi-Layer Cell Culture Systems	144
Erlenmeyer Flasks	147
Large-capacity Erlenmeyer Flasks	148
Multi-layer Cell Culture Flasks	149
New Specs Roller Bottles	151
New Cell Culture Bags	153

Storage and Transfer of Bioprocessing Fluid

New 2D Single-Use Storage Bags	155
New Closed System for Erlenmeyer Flasks	156
New Closed System for Media Bottles	158
New Closed System for Centrifuge Tubes/Bottles	162

Bioprocess Filtration

New PureFlow™ Capsule Sterilizing Filters	164
--	-----

4 Medical Devices

New Specialized Consumables for Assist Reproduction	168
Disposable Virus Sampling Tubes	170

6 Laboratory Instruments

JetPip™ Plus	180
JetPip™ Pipette Controller	180
Multichannel Micro Pipettors	181
Micro Volume Pipettors	182



Cell Culture Products



With numerous international agree leading key core technologies and advanced production processes for laboratory consumables, JET BIOFIL has consistently produced high-quality cell culture products over the more than two decades to ensure agree the best repeatability and the most reliable results in studies, and our products are therefore widely used by researchers. Dozens of surfaces of culture vessels ranging from 0.11 cm² to 25,680 cm², the cell culture products of JET BIOFIL are suitable for most applications and can meet your different demands for cell culture. Our products are DNase/RNase, pyrogen-free, and non-cytotoxic. They are made of high-quality raw materials that conform to USP Class VI standards and are produced in a Class 100,000 clean workshop in strict accordance with ISO 9001 and ISO 13485. All products have undergone cell line testing and strict quality validation, and they have consistently showed stable performance. These products mainly include cell and tissue culture flasks, cell and tissue culture dishes, cell and tissue culture plates and other products.

Cell and Tissue Culture Flasks

Cell and tissue culture flasks are the most suitable culture vessels for long-term and large-scale laboratory cell culture while preventing contamination. The surface untreated flasks are suitable for suspension cells culture, while those with a TC-treated surface are suitable for common adherent cell lines due to the excellent hydrophilicity of the polystyrene surface. The CellATTACH® superhydrophilic treated surface represents a technical advancement that improves the adhesion and growth of difficult-to-nourish cells, primary cells and transfection cell lines under low serum/serum-free conditions.

- Specification: T12.5 T25 T75 T150 T175 T182 T182 (Extra Height) T225 T300
- Type of Cap: Plug Seal Vent
- Surface: Non-treated TC-treated CellATTACH®-treated
- Materials: Flask Body: Polystyrene (PS)
Bottle Cap: High-density Polyethylene (HDPE)
Filter Membrane: Polytetrafluoroethylene (PTFE), conforming to USP Class VI standards



Ergonomic cap design-open/close by rotating 1/4 of its full range.



Clear graduations are shown on both sides and the frosted area can be marked.



The tilted bottleneck facilitates liquid pouring, as well as convenient operations of pipettes and cell scrapers.

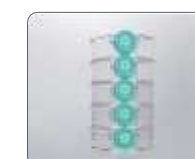

0.22 µm PTFE hydrophobic vent cap supports gas exchange and prevents cross-contamination.

Features

- Various treated surfaces are suitable for different culture needs
- The hydrophobic vent cap ensures continuous ventilation, enabled by turning the cap 1/4 of its full range
- The tilted bottleneck facilitates easy access of pipets and cell scrapers
- Low profile design supports effective use of the internal space of the incubator when stacked
- The frosted area near the bottleneck can be written on
- Volume graduations molded on both sides
- 100% tested for production line leakage
- Lot No. on the bottom of each flask and package bag for quality traceability
- Sterilized by irradiation, SAL 10⁻⁶
- DNase/RNase-free, non-pyrogenic and non-cytotoxic

Cell and Tissue Culture Flasks, Non-treated

Cat. No.	Volume (mL)	Cell Culture Surface Area (cm ²)	Maximum Working Volume (mL)	Type of Cap	Dimensions(mm)				Sterile	Qty. Per Bag	Qty. Per Case
					L	W	H	B.N.D*			
TCF001025	25.0	12.5	8	Plug Seal	73.7	40.4	22.8	14.2	Y	10	200
TCF002025	25.0	12.5	8	Vent	73.7	40.4	22.8	14.2	Y	10	200
TCF001050	50.0	25.0	17.5	Plug Seal	92.9	49.5	29.1	18.2	Y	10	200
TCF002050	50.0	25.0	17.5	Vent	92.9	49.5	29.1	18.2	Y	10	200
TCF001250	250.0	75.0	60	Plug Seal	152.5	81.5	35.2	25.0	Y	5	100
TCF002250	250.0	75.0	60	Vent	152.5	81.5	35.2	25.0	Y	5	100
TCF001150	375.0	150.0 (U-shaped)	140	Plug Seal	199.7	111.3	111.3	25.6	Y	5	50
TCF002150	375.0	150.0	140	Vent	199.7	111.3	111.3	25.6	Y	5	50
TCF001175	600.0	175.0	250	Plug Seal	199.9	122.7	49.2	25.7	Y	5	50
TCF002175	600.0	175.0	250	Vent	199.9	122.7	49.2	25.7	Y	5	50
TCF001600	600.0	182.0	125	Plug Seal	219.3	115.7	38.3	29.5	Y	5	40
TCF002600	600.0	182.0	125	Vent	219.3	115.7	38.3	29.5	Y	5	40
TCF101600	600.0	182.0 (Extended)	200	Plug Seal	219.3	115.7	49.5	29.5	Y	5	40
TCF102600	600.0	182.0	200	Vent	219.3	115.7	49.5	29.5	Y	5	40
TCF001225	850.0	225.0	400	Plug Seal	221.9	137.2	49.5	25.7	Y	5	25
TCF002225	850.0	225.0	400	Vent	221.9	137.2	49.5	25.7	Y	5	25
TCF001850	850.0	300.0	200	Plug Seal	269.2	166.0	47.0	29.5	Y	3	18
TCF002850	850.0	300.0	200	Vent	269.2	166.0	47.0	29.5	Y	3	18

* Bottle Neck Diameter

Cell and Tissue Culture Flasks, TC-treated

Cat. No.	Volume (mL)	Recommended Working Volume (mL)	Cell Culture Surface Area (cm ²)	Maximum Working Volume (mL)	Type of Cap	Dimensions(mm)				Sterile	Qty. Per Bag	Qty. Per Case
						L	W	H	B.N.D*			
TCF011025	25.0	2.5-3.8	12.5	8	Plug Seal	73.7	40.4	22.8	14.2	Y	10	200
TCF012025	25.0	2.5-3.8	12.5	8	Vent	73.7	40.4	22.8	14.2	Y	10	200
TCF011050	50.0	5-7.5	25.0	17.5	Plug Seal	92.9	49.5	29.1	18.2	Y	10	200
TCF012050	50.0	5-7.5	25.0	17.5	Vent	92.9	49.5	29.1	18.2	Y	10	200
TCF011250	250.0	15-22.5	75.0	60	Plug Seal	152.5	81.5	35.2	25.0	Y	5	100
TCF012250	250.0	15-22.5	75.0	60	Vent	152.5	81.5	35.2	25.0	Y	5	100
TCF011150	375.0	30-45	150.0 (U-shaped)	140	Plug Seal	199.7	111.3	111.3	25.6	Y	5	50
TCF022150	375.0	30-45	150.0	140	Vent	199.7	111.3	111.3	25.6	Y	5	50
TCF011175	600.0	35-52.5	175.0	250	Plug Seal	199.9	122.7	49.2	25.7	Y	5	50
TCF012175	600.0	35-52.5	175.0	250	Vent	199.9	122.7	49.2	25.7	Y	5	50
TCF011600	600.0	36.4-54.6	182.0	125	Plug Seal	219.3	115.7	38.3	29.5	Y	5	40
TCF012600	600.0	36.4-54.6	182.0	125	Vent	219.3	115.7	38.3	29.5	Y	5	40
TCF111600	600.0	36.4-54.6	182.0 (Extended)	200	Plug Seal	219.3	115.7	49.5	29.5	Y	5	40
TCF112600	600.0	36.4-54.6	182.0	200	Vent	219.3	115.7	49.5	29.5	Y	5	40
TCF011225	850.0	45-67.5	225.0	400	Plug Seal	221.9	137.2	49.5	25.7	Y	5	25
TCF012225	850.0	45-67.5	225.0	400	Vent	221.9	137.2	49.5	25.7	Y	5	25
TCF011850	850.0	60-90	300.0	200	Plug Seal	269.2	166.0	47.0	29.5	Y	3	18
TCF012850	850.0	60-90	300.0	200	Vent	269.2	166.0	47.0	29.5	Y	3	18

* Bottle Neck Diameter

Cell and Tissue Culture Dishes

Cell and tissue culture dishes can be used for culturing plants, animal cells, and microbes. The non-treated surface dishes are suitable for suspension cell cultures, while those with the TC-treated surface are suitable for common adherent cell lines due to the excellent hydrophilicity of the polystyrene surface. The CellATTACH® superhydrophilic treated surface represents a technical advancement that improves the adhesion and growth of fastidious cells, primary cells and transfection cell lines under low serum/serum-free conditions.

- Specification: 18 mm 35 mm 60 mm 60 mm (Center Well) 70 mm 90 mm 100 mm 150 mm
- Surface: Non-treated TC-treated CellATTACH®-treated
- Materials: Polystyrene (PS), conforming to USP Class VI standards



The gear ring design facilitates easy gripping during use, thus reducing the risk of contamination



The ring-shaped protrusion of the culture dish cap enables stable stacking



The notched design on the lid's inwall ensures both sterility and air ventilation



The positioning markers at the bottom of the culture dish facilitate the positioning of cells.

Features

- Various treated surfaces are suitable for different culture needs
- The gear ring design on the side makes it easier to hold and reduces contamination.
- The ring-shaped protrusion on the lid fits perfectly with the bottom of the dish to facilitate stacking of culture dishes
- Dish cover has three air-permeable edges, allowing gas exchange while ensuring a sterile condition
- The sterile ziplock packaging enables repeated sealing
- Sterilized by irradiation, SAL 10⁻⁶
- DNase/RNase-free, non-pyrogenic and non-cytotoxic

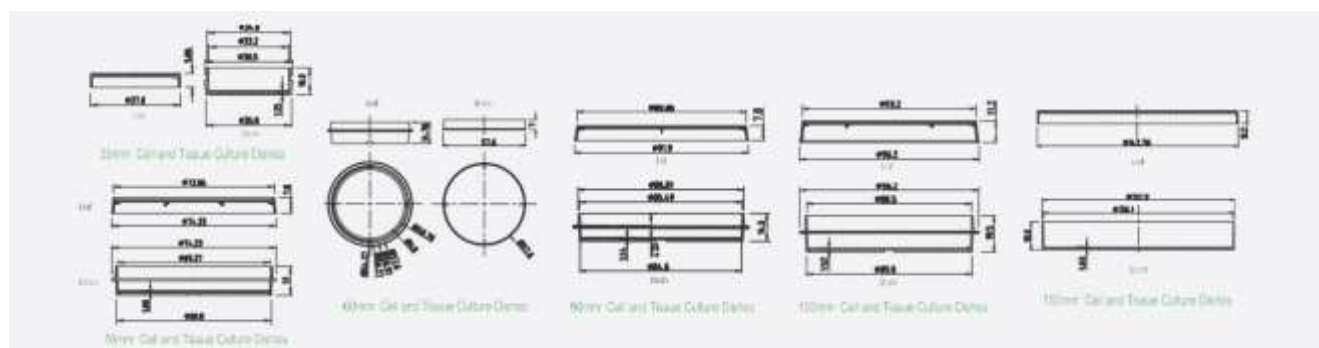

Cell and Tissue Culture Dishes , Non-treated

Cat. No.	Diameter(mm)	Height(mm)	Culture Area (cm ²)	Recommended Working Volume (mL)	Qty. Per Bag	Qty. Per Case
TCD000018	18	12.1	1.4	-	10	300
TCD000035	35	12.6	8.5	2-3.5	10	960
TCD000060	60	17.3	21.2	4-7	10	600
TCD100060	60 (Center Well)	16.0	/	4-7	10	600
TCD000070	70	15.5	36.3	6-11	10	600
TCD000090	90	16.9	55.0	10-18	10	500
TCD000100	100	22.6	60.8	12-20	10	300
TCD000150	150	22.7	143.0	25-50	1	120

Cell and Tissue Culture Dishes, with TC-treated

TCD010018	18	12.1	1.4	-	10	300
TCD010035	35	12.6	8.5	2-3.5	10	960
TCD010060	60	17.3	21.2	4-7	10	600
TCD110060	60 (Center Well)	16.0	/	4-7	10	600
TCD010070	70	15.5	36.3	6-11	10	600
TCD010090	90	16.9	55.0	10-18	10	500
TCD010100	100	22.6	60.8	12-20	10	300
TCD010150	150	22.7	143.0	25-50	1	120
TCD110150	150	22.7	143.0	25-50	5	100

Height: total height that combines cap and dish

Cell and Tissue Culture Plates

We supply premium cell culture plates with a range of specifications and surfaces for experimental research, optimization and analysis to deliver the best outcomes for cell culture and subsequent cell assays, such as cell transfection, immunofluorescence, and clone formation. Assisting with experimental research, optimization and analysis. Surface-untreated plates are suitable for suspension cell cultures, and those with a TC-treated surface are suitable for common adherent cell lines due to the excellent hydrophilicity of the polystyrene surface. The CellATTACH® superhydrophilic treated surface represents a technical advancement that OR and allows better adhesion and proliferation of fastidious cells as well as primary or transfected cell lines under low serum/serum-free conditions.

- Specification: Single well 4-well 6-well 12-well 24-well 48-well 96-well 96-well (detachable) 384-well
- Surface: Non-treated TC-treated CellATTACH®-treated
- Packaging: Blister pack
- Materials: Non-removeable Plate & Stripe: Polystyrene (PS) Removeable Plate Frame: High Impact Polystyrene (HIPS), conforming to USP Class VI standards
- Bottom type: Flat U-shaped

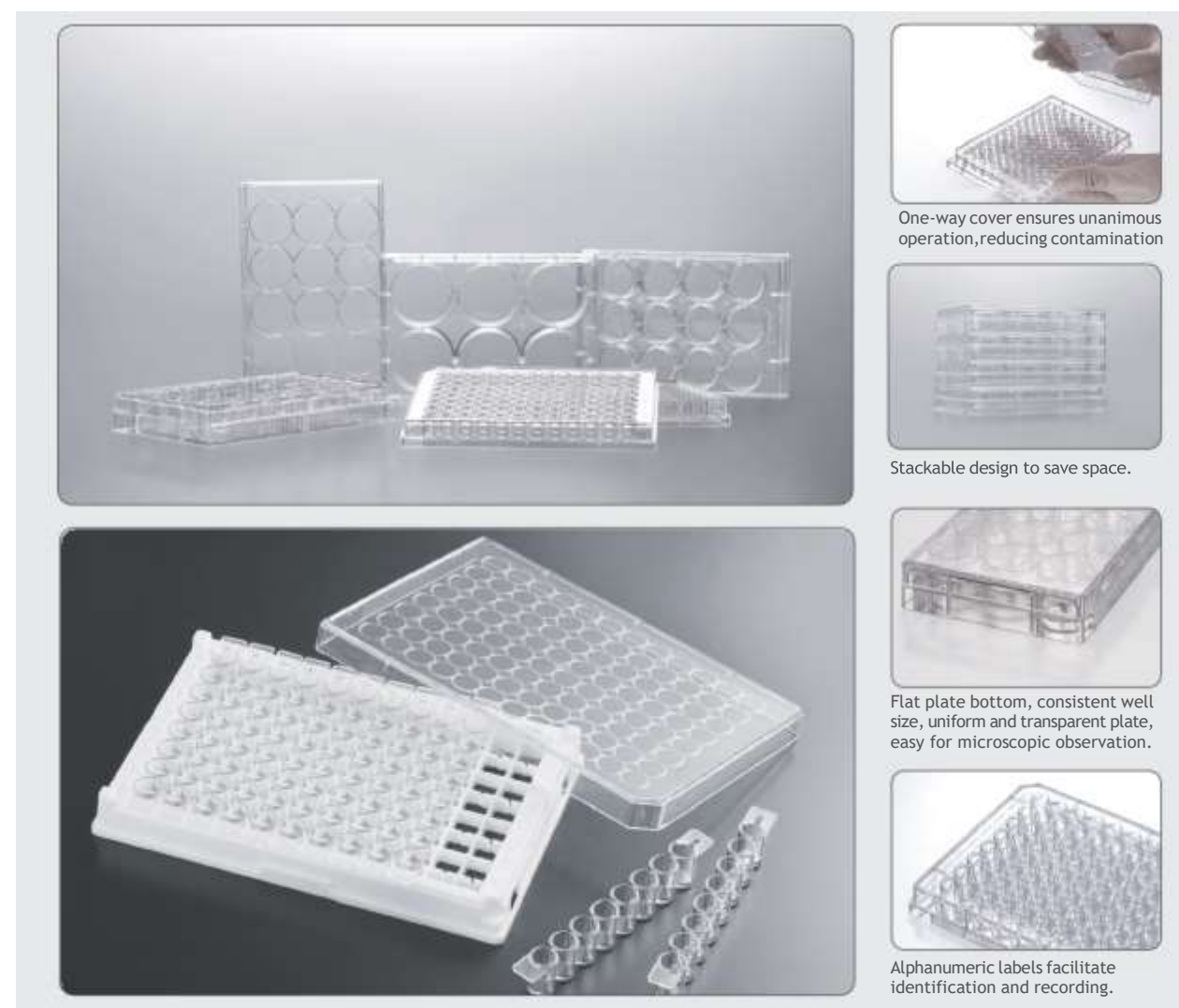

One-way cover ensures unanimous operation, reducing contamination

Stackable design to save space.

Flat plate bottom, consistent well size, uniform and transparent plate, easy for microscopic observation.

Alphanumeric labels facilitate identification and recording.

Features

- Uniform thickness of plate bottom and well size.
- Plates with U-shaped bottom are suitable for suspension culture, chemical and analytical experiment, or sample preservation. The detachable 96-well plate is suitable for experimental analysis.
- Transparent material facilitates observation under a microscope.
- Plate cover and plate body fit tightly, thus reducing contamination of the medium or evaporation loss during the cell culture process.
- The ergonomically designed one-way cover can be held easily, reducing mistakes.
- The well edge design prevents cross-contamination, with alphanumeric markers to facilitate identification and marking.
- Stackable space-saving design conforming to ANSI/SLAS standards, compatible with most multi-well plate instruments and equipment
- Lot No. printed at the sides of the plate and package bag facilitates quality traceability.
- Sterilized by irradiation, SAL 10⁶
- DNase/RNase-free, non-pyrogenic and non-cytotoxic

Cell and Tissue Culture Plates , Non-treated , in Blister Box

Cat . No .	Surface Type	Specification (Well)	Well Type	max . Working Volume of a Single Well (mL)	Recommended Working Volume of a Single Well (mL)	Qty. Per Bag	Qty. Per Case
TCP001001	Non-treated	Single well	Flat	90	35.0	1	100
TCP001004	Non-treated	4	Flat	1.86	1.0	1	100
TCP001006	Non-treated	6	Flat	17.0	1.9-2.9	1	100
TCP001012	Non-treated	12	Flat	6.80	0.76-1.14	1	100
TCP001024	Non-treated	24	Flat	3.50	0.38-0.57	1	100
TCP001048	Non-treated	48	Flat	1.55	0.19-0.29	1	100
TCP001096	Non-treated	96	Flat	0.39	0.075-0.2	1	100
TCP002096	Non-treated	96	U-shaped	0.33	0.075-0.2	1	100
TCP001896	Non-treated	96 (detachable, with 8-well strips)	Flat	0.39	0.075-0.2	1	100
TCP001384	Non-treated	384	Flat	0.145	0.01-0.1	1	100

Cell and Tissue Culture Plates, with TC-treated, in Blister Box

Cat . No .	Surface Type	Specification (Well)	Well Type	Max . Working Volume of a Single Well (mL)	Recommended Working Volume of a Single Well (mL)	Culture Area of a Single Well (cm ²)	Qty. Per Bag	Qty. Per Case
TCP011001	TC-treated	Single well	Flat	90	35.0	97	1	100
TCP011004	TC-treated	4	Flat	1.86	1.0	1.96	1	100
TCP011006	TC-treated	6	Flat	17.0	1.9-2.9	9.6	1	100
TCP011012	TC-treated	12	Flat	6.80	0.76-1.14	3.85	1	100
TCP011024	TC-treated	24	Flat	3.50	0.38-0.57	1.93	1	100
TCP011048	TC-treated	48	Flat	1.55	0.19-0.29	0.84	1	100
TCP011096	TC-treated	96	Flat	0.39	0.075-0.2	0.33	1	100
TCP012096	TC-treated	96	U-shaped	0.33	0.075-0.2	0.58	1	100
TCP011896	TC-treated	96 (detachable, with 8-well strips)	Flat	0.39	0.075-0.2	0.33	1	100
TCP011384	TC-treated	384	Flat	0.145	0.01-0.1	0.1135	1	100

96-well Solid Black/White Cell Culture Plates

Solid Black/White cell culture plates are designed for laboratory cell culture as well as fluorescence and chemiluminescence analysis. Jet Biofil's 96-well Solid Black/White Cell Culture Plates are made from premium polystyrene material with a TC-treated surface, providing excellent cell adhesion and suitability for cell culture.

Black culture plates: Absorb refracted and reflected light, reduce background light signals, and minimize well-to-well crosstalk, making them ideal for fluorescence analysis experiments.

White culture plates: Reflect and enhance light signals, minimize well-to-well crosstalk, ideal for chemiluminescence analysis experiments.

- Specifications: 96-well
- Bottom type: Flat
- Color: Black White
- Material: Polystyrene (PS), conforming to USP Class VI standards



Features

- TC-treated surface ensures excellent cell adhesion, suitable for cell culture
- The unidirectional lid fits snugly with the plate body, features a condensation ring for ventilation, and prevents contamination or loss of culture medium
- Raised well rims prevent cross-contamination of samples, labeled and numbered for easy left side, top side, and well-to-well identification
- Uniform bottom thickness and consistent well diameters. Plate dimensions conform to ANSI/SLAS standards, compatible with most common equipment
- Maximum working volume per well: 0.39 mL. Recommended working volume: 0.075-0.2 mL. Culture area: 0.33 cm² per well
- Sterilized by irradiation, SAL 10⁶
- DNase/RNase-free, non-pyrogenic and non-cytotoxic

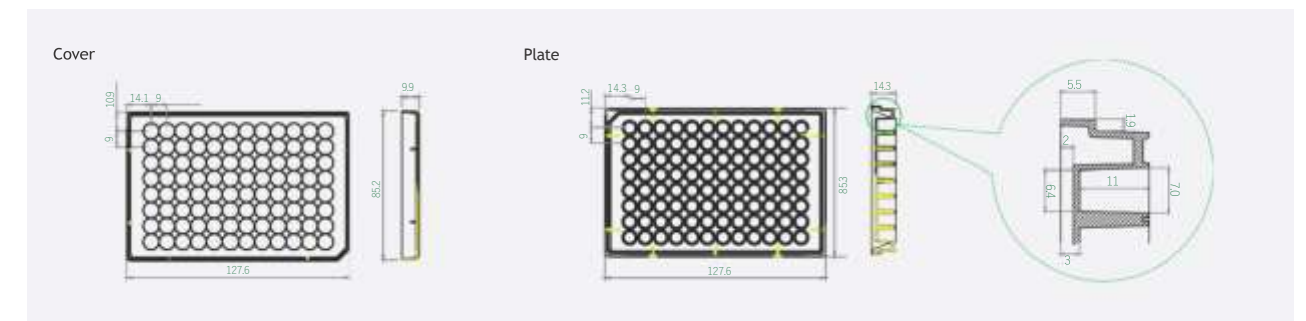

Cat . No .	Well	Color	Bottom Type	Surface	Growth Area per Well (cm ²)	Maximum Working Volume per Well (mL)	Recommended Working Volume per Well (mL)	Sterile	Qty. Per Box	Qty. Per Case
TCP019096	96	Black	Flat	TC-treated	0.33	0.39	0.075-0.2	Y	1	100
TCP017096	96	Whit	Flat	TC-treated	0.33	0.39	0.075-0.2	Y	1	100

CellATTACH® Cell and Tissue Culture Products

The CellATTACH® superhydrophilic cell culture product series is created by introducing polar groups onto their surfaces. This forms a durable and stable superhydrophilic surface that facilitates good adherent growth of various types of cells under different culture conditions, thereby improving cell yield. The treated surface also eliminates the need for unstable, time-consuming, and costly biological coating.

- Cell and Tissue Culture Flasks: T12.5 T25 T75 T182 T300 Cap Style: Plug Seal Vent
- Cell and Tissue Culture Plates: 6-well 12-well 24-well 48-well 96-well
- Cell and Tissue Culture Dishes: 35 mm 60 mm 70 mm 90 mm 100 mm 150 mm
- Materials: Flask/Plate/Dish Body: Polystyrene (PS), Flask Cap: High-density Polyethylene (HDPE), Filter Membrane: Polytetrafluoroethylene (PTFE), conforming to USP Class VI standards

Features

- Unique superhydrophilic surface treatment technology provides better adherence for cells, promoting rapid cell growth and increasing yields.
- This ensures continuous and uniform cell adherence, and can be used for adherent cultures of primary cells, neuronal cells, stem cells and other fastidious cells that have more stringent requirements for the hydrophilicity of the culture surface.
- Cells can adapt quickly to a serum-free or low-serum culture environment, meeting the needs of experiments that require the elimination of interference by serum components or that require reduced serum levels, thus reducing the cost of cell culture.

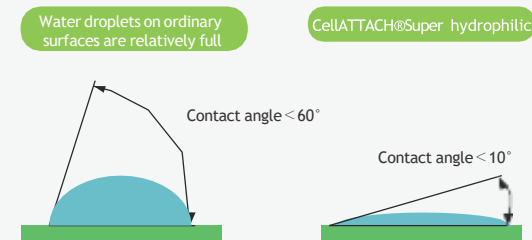

CellATTACH® Cell and Tissue Culture Flasks

Cat. No.	Volume (mL)	Cell Culture Surface Area (cm ²)	Recommended Working Volume (mL)	Maximum Working Volume (mL)	Cap Style	Dimensions(mm)				Sterile	Qty. Per Pack	Qty. Per Case
						L	W	H	B.N.D*			
CAF011025	25.0	12.5	2.5-3.8	8	Plug Seal	73.7	40.4	22.8	14.2	Y	10	200
CAF012025	25.0	12.5	2.5-3.8	8	Vent	73.7	40.4	22.8	14.2	Y	10	200
CAF011050	50.0	25.0	5-7.5	17.5	Plug Seal	92.9	49.5	29.1	18.2	Y	10	200
CAF012050	50.0	25.0	5-7.5	17.5	Vent	92.9	49.5	29.1	18.2	Y	10	200
CAF011250	250.0	75.0	15-22.5	60	Plug Seal	152.5	81.5	35.2	25.0	Y	5	100
CAF012250	250.0	75.0	15-22.5	60	Vent	152.5	81.5	35.2	25.0	Y	5	100
CAF011600	600.0	182.0	36.4-54.6	125	Plug Seal	219.3	115.7	38.3	29.5	Y	5	40
CAF012600	600.0	182.0	36.4-54.6	125	Vent	219.3	115.7	38.3	29.5	Y	5	40
CAF111600	600.0	182.0 (Extended)	36.4-54.6	200	Plug Seal	219.3	115.7	49.5	29.5	Y	5	40
CAF112600	600.0	182.0	36.4-54.6	200	Vent	219.3	115.7	49.5	29.5	Y	5	40
CAF011850	850.0	300.0	60-90	200	Plug Seal	269.2	166.0	47.0	29.5	Y	3	18
CAF012850	850.0	300.0	60-90	200	Vent	269.2	166.0	47.0	29.5	Y	3	18

* Bottle Neck Diameter

CAP011006	6	Flat	17.0	1.90-2.90	1	100
CAP011012	12	Flat	6.8	0.76-1.14	1	100
CAP011024	24	Flat	3.5	0.38-0.57	1	100
CAP011048	48	Flat	1.6	0.19-0.29	1	100
CAP011096	96	Flat	0.3	0.08-0.20	1	100
CAP012096	96U	U-shape	0.3	0.08-0.20	1	100

CellATTACH® Cell and Tissue Culture Dishes

					Case
CAD010035	35	12.6	8.5	10	240
CAD010060	60	17.3	21.2	10	240
CAD010070	70	15.5	36.3	10	240
CAD010090	90	16.9	58.4	10	240
CAD010100	100	22.6	60.8	10	240
CAD010150	150	22.7	143.0	5	80

CellDETACH™ Temperature-Responsive Cell Culture Surface

Using trypsin digestion or cell scrapers to separate adherent cells can affect the expression of cell surface proteins, damage cells and reduce cell viability.

The CellDETACH™ products have a thermosensitive surface, which is coated with a unique nanopolymer. When the temperature decreases from 37°C to 4°C, the thermosensitive surface gradually changes from slightly hydrophobic to hydrophilic, allowing for the harvest of adherent cells without trypsin. By using this gentle collection method, the cells are safe from injuries caused by trypsin or scrapers, thus preserving high viability and the integrity of surface receptors and cell antigens. This operation enables cells to be harvested without damage for subculturing.

- Products: CellDETACH™ thermosensitive cell culture dishes 100 mm
CellDETACH™ thermosensitive cell culture flasks 600 mL

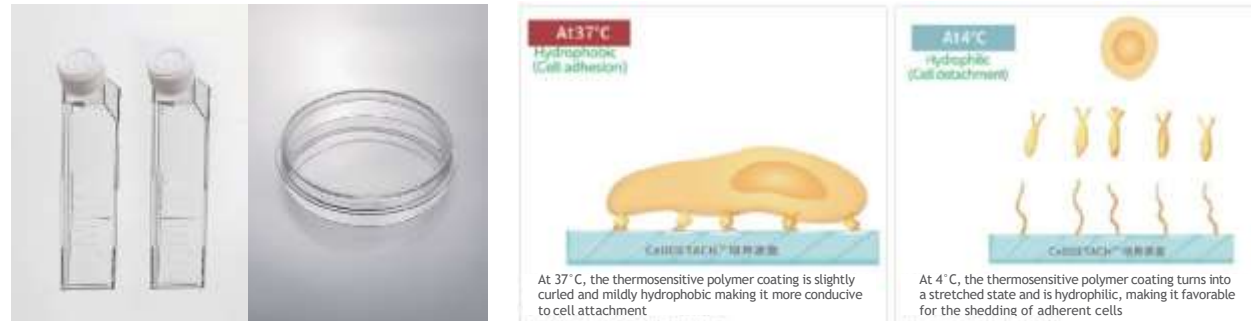

Features

The CellDETACH™ thermosensitive cell culture surface is specially designed by our R&D team for cell passage and cell transplantation, and has been granted a national invention patent (Patent Number: ZL201510780506.3). The goal is to help researchers harvest cell sheets, set up 3D tissue models formed by normal cell binding and extracellular matrix linkage, simplify cell culture and tissue engineering techniques, and minimize experimental manipulation time.

- China Invention Patent Award (patent number: ZL201510780506.3)
- Induces cell shedding simply by lowering the temperature-straightforward, fast, and easy to operate
- No trypsin: preserves cell surface proteins and marker integrity
- No cell scraping: avoids mechanical damage to cells and ensures high cell viability
- Optimized cell culture and tissue engineering techniques

Scope of Application

The thermosensitive cell culture surface is suitable for in vitro culture of most adherent cells, including stem cells, neural cells, macrophages, and cancer cells. It is ideal for harmless cell harvesting and can be widely used in expanded cell culture, cell therapy, 3D tissue modeling, extracellular matrix research and other fields.

CellDETACH® Cell and Tissue Culture Dishes

Cat. No.	Diameter (mm)	Sterile	Growth Area (cm ²)	Qty. Per Pack (Blister)	Qty. Per Case
CDD022100	100	Y	60.8	1	24
CDD023100	100	Y	60.8	5	100

CellDETACH® Cell and Tissue Culture Flasks

Cat. No.	Volume (mL)	Growth Area (cm ²)	Recommended Working Volume (mL)	Maximum Working Volume (mL)	Cap Style	Dimensions (mm)			B.N.D.*	Sterile	Qty. Per Bag	Qty. Per Case
						L	W	H				
CDF024600	600	182 (Extended)	36.4-54.6	200	Vent	219.3	115.7	49.5	29.5	Y	1	20
CDF023600	600	182 (Extended)	36.4-54.6	200	Vent	219.3	115.7	49.5	29.5	Y	5	40
CDF014600	600	182 (Extended)	36.4-54.6	200	Plug Seal	219.3	115.7	49.5	29.5	Y	1	20
CDF013600	600	182 (Extended)	36.4-54.6	200	Plug Seal	219.3	115.7	49.5	29.5	Y	5	40

* Bottle Neck Diameter

3D Sphero™ Ultra-low Adsorption Surface

The 3D Sphero™ Ultra-low Adsorption Surface of JET BIOFIL is designed for spheroids (e.g. 3D tumor spheroid) and organoid cultures, providing a variety of product forms such as culture plates, culture dishes, and culture flasks. After the surface of the product is subjected to special gel treatment, the product has extremely strong anti-protein adsorption and anti-cell attachment, and there is almost no cell attachment on the surface, which is conducive to the suspension growth of cells and enables cell spheroid culture in a rapid, consistent, and reproducible manner.

- Specification: Ultra-low adsorption cell and tissue culture plates 6-well, 96-well (Flat bottom), 96-well (U-shaped bottom)
Ultra-low adsorption culture dishes (60 mm; 100 mm)
Ultra-low adsorption culture flask T75
- Material: Polystyrene (PS), Flask cap: High-density polyethylene (HDPE), conforming to USP Class VI standards

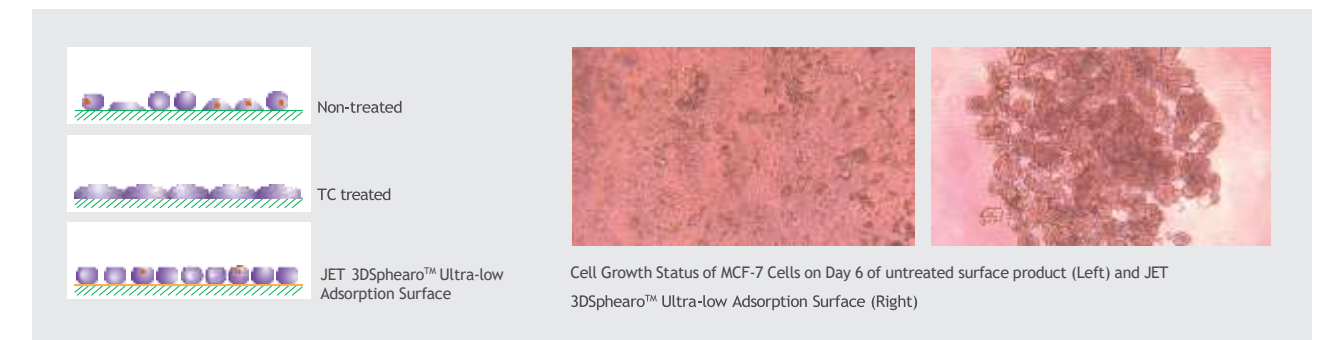

Features

- The Ultra-low Adsorption Surface has a covalently bonded hydrogel layer with extremely strong anti-protein adsorption and anti-cell attachment, which can effectively inhibit cell attachment and minimize protein adsorption, enzyme activation, and cell activation
- The surface is non-cytotoxic, biologically inert and non-degradable
- The coating on the surface is firm and convenient for daily experimental operation
- It has been verified by different cell culture tests that there is almost no cell attachment on the surface and enables cell spheroid culture in a rapid, reproducible, consistent, and reliable manner
- Provide a variety of Ultra-low Adsorption Surface to meet different experimental needs of customers
- Each package bag is printed with lot No. for quality traceability
- Sterilized by irradiation, SAL 10⁶
- DNase/RNase-free, non-pyrogenic, and non-cytotoxic

Cat. No.	Product Name	Specification	Surface Type	Sterile	Qty. Per Bag	Qty. Per Case
TCP030006	Culture plate	6-well	Ultra-low adsorption	Y	1	60
TCP030096	Culture plate	96-well (Flat bottom)	Ultra-low adsorption	Y	1	60
TCP130096	Culture plate	96-well (U-shaped bottom)	Ultra-low adsorption	Y	1	60
TCD030060	Culture dish	60 mm	Ultra-low adsorption	Y	5	80
TCD030100	Culture dish	100 mm	Ultra-low adsorption	Y	5	80
TCF030250	Culture flask	T75 (250 mL, vent)	Ultra-low adsorption	Y	1	60

Poly-D-Lysine-coated Products

Poly-D-Lysine serves as a positively charged extracellular matrix, fostering nonspecific cell attachment. Upon application to solid-phase culture surfaces, it heightens the electrostatic interaction between negatively charged ions on the cell membrane surface and positively charged ions on the culture surface. This enhancement bolsters cell attachment rates in serum-free or low-serum culture settings and reinforces the absorption of serum proteins and extracellular matrix proteins onto the culture surface.

Jet Biofil's Poly-D-Lysine-coated Products are available in a variety of forms, including culture plates and dishes. The product surface is pre-coated with Poly-D-lysine, which facilitates the attachment growth, proliferation and differentiation of cells that are difficult to culture, such as neurons, glial cells and transfected cell lines.

- Specification: Poly-D-Lysine-coated culture plates (6-well, 12-well and 24-well)
Poly-D-Lysine-coated culture dishes (35 mm, 60 mm and 90 mm)

Features

- Utilizing premium poly-D-lysine characterized by a molecular weight ranging from 75 to 150 kDa, boasting high viscosity and robust cell attachment properties
- Enhance the attachment, growth, and specialization of challenging cell types, such as neurons, in culture
- Synthetic poly-D-lysine aims to prevent the stimulation of biological activity resulting from the introduction of natural polymers, impurity proteins, and similar factors
- Following validation through diverse cell culture tests, the attachment rate of cells surpasses 90%, with the viability of attachment cells exceeding 95%
- We offer a range of pre-coated poly-D-lysine product forms ready for use, catering to diverse testing requirements of our customers
- Lot number of each package bag is printed to ensure quality traceability
- Sterilized by irradiation, SAL 10^6 , DNase/RNase-free, and non-pyrogenic



Inoculate PC-12 cells onto a poly-D-lysine-coated 24-well cell culture plate at a density of 5×10^4 cells/well. After 24 hours, observe under a microscope: The cell morphology appears normal, exhibiting an attachment rate surpassing 90% and the viability of attachment cells exceeding 95%.

Cat. No.	Product Name	Specification	Surface	Sterile	Qty./Bag	Qty./Case
TCP040006	Culture plate	6-well	Poly-D-lysine Coated	Y	1	60
TCP040012	Culture plate	12-well	Poly-D-lysine Coated	Y	1	60
TCP040024	Culture plate	24-well	Poly-D-lysine Coated	Y	1	60
TCD040035	Culture dish	35mm	Poly-D-lysine Coated	Y	5	80
TCD040060	Culture dish	60mm	Poly-D-lysine Coated	Y	5	80
TCD040090	Culture dish	90mm	Poly-D-lysine Coated	Y	5	80

Storage instructions: Store product in dry environment between 4-30°C away from direct sunlight. The product has a shelf life of 2 years.

Tissue Culture Plate Inserts

Tissue culture plate inserts are extensively used in a variety of cell tests, including co-culture tests, chemotaxis tests, and cell migration tests. With the membrane technology, cells that grow in vitro are more similar to those growing in vivo in terms of morphology and function. They are also used for studying cell functions such as cellular transport, absorption and secretion.

- Membrane Pore Size: 0.1 μm 0.4 μm 1 μm 3.0 μm 5.0 μm 8.0 μm 12.0 μm
- Specification: 6-well 12-well 24-well
- Materials: Membrane: Polycarbonate(PC)/Polyethylene terephthalate(PET),
Main Body: Polystyrene (PS), conforming to USP Class VI standards



Features

- Excellent transmittance of the PET membrane, facilitating observation by microscope; Compared to the PET membrane, cell adhesion is stronger on the PC membrane and its higher pore density enables easier exchange of transmembrane substances
- 3 configurations of cell culture plate inserts and a variety of membrane pore sizes are available to meet a variety of different experimental requirements
- Innovative nested edge design facilitates sample addition
- Special central suspension design protects monolayer cells while preventing cell culture medium loss
- Excellent chemical compatibility of the membrane makes it compatible with most staining and fixed reagents
- Sterilized by irradiation, SAL 10^6
- DNase/RNase-free, non-pyrogenic and non-cytotoxic

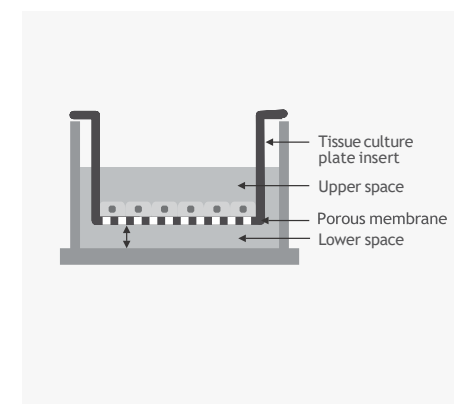

Chemical Compatibility

The PC membrane and PET membrane are suitable for histological fixatives such as methanol and formaldehyde, and also tolerate alcohol, amines, lipids, ethers, ketones and petroleum solvents (such as halogenated hydrocarbon and DMSO). In particular, the PC membrane has very good chemical applicability. However, strong acid and alkaline solutions are not recommended.

Pore Density

The PET membrane and PC membrane have a rated pore density. In comparison, the PET membrane has a lower pore density than the PC membrane but is superior in terms of its optical performance. The central suspension design of our tissue culture plate inserts leaves a certain distance between the nest and the bottom, so that the monolayer cells will not be destroyed when the nest is moved away, and culture medium loss via capillary action between the nested wall and pore wall can be prevented.

Polycarbonate (PC) Membrane Tissue Culture Plate Inserts

Cat. No.	Well	Pore Size (µm)	Growth Area for Insert Membrane (cm ²)	Sterile	Qty. Per Box	Qty. Per Case
TCS000006	6	0.1	4.7	Y	6	24
TCS001006	6	0.4	4.7	Y	6	24
TCS005006	6	1.0	4.7	Y	6	24
TCS002006	6	3.0	4.7	Y	6	24
TCS003006	6	8.0	4.7	Y	6	24
TCS100006	6	12.0	4.7	Y	6	24
TCS000012	12	0.1	1.1	Y	12	48
TCS001012	12	0.4	1.1	Y	12	48
TCS005012	12	1.0	1.1	Y	12	48
TCS002012	12	3.0	1.1	Y	12	48
TCS003012	12	8.0	1.1	Y	12	48
TCS100012	12	12.0	1.1	Y	12	48
TCS000024	24	0.1	0.3	Y	12	48
TCS001024	24	0.4	0.3	Y	12	48
TCS005024	24	1.0	0.3	Y	12	48
TCS002024	24	3.0	0.3	Y	12	48
TCS003024	24	8.0	0.3	Y	12	48
TCS004024	24	5.0	0.3	Y	12	48
TCS100024	24	12.0	0.3	Y	12	48

Polyethylene Terephthalate (PET) Membrane Tissue Culture Plate Inserts

Cat. No.	Well	Pore Size (µm)	Growth Area for Insert Membrane (cm ²)	Sterile	Qty. Per Box	Qty. Per Case
TCS017006	6	0.1	4.7	Y	6	24
TCS016006	6	0.4	4.7	Y	6	24
TCS018006	6	1.0	4.7	Y	6	24
TCS019006	6	3.0	4.7	Y	6	24
TCS020006	6	8.0	4.7	Y	6	24
TCS017012	12	0.1	1.1	Y	12	48
TCS016012	12	0.4	1.1	Y	12	48
TCS018012	12	1.0	1.1	Y	12	48
TCS019012	12	3.0	1.1	Y	12	48
TCS020012	12	8.0	1.1	Y	12	48
TCS017024	24	0.1	0.3	Y	12	48
TCS016024	24	0.4	0.3	Y	12	48
TCS018024	24	1.0	0.3	Y	12	48
TCS019024	24	3.0	0.3	Y	12	48
TCS020024	24	8.0	0.3	Y	12	48

Polycarbonate (PC) Membrane Tissue Culture Plate Inserts

Cat. No.	Pore Size (µm)	Culture Area (cm ²)	Suggested Working Volume (mL)	Qty. Per Plate	Qty. Per Case
TCS021024	0.4	0.5	1.1	24	96

100 mm Tissue Culture Dish Inserts

Tissue Culture Dish Inserts are extensively used in a variety of cell experiments. The membrane technology is used to simulate the original growth environment of cells and make cells growing in vitro closer to cells growing in vivo in terms of morphology and function. The 100 mm Tissue Culture Dish Inserts from JET BIOFIL are made of translucent polycarbonate membranes (PC), providing superior cell adhesion, high pore density, and enhanced capacity for transmembrane substance exchange. The inserts are ideal for various tests such as co-culturing and cellular molecular transport, as well as research into cell functions like transport, absorption and secretion.

- Insert Diameter: 75 mm
- Culture dish Diameter: 100 mm
- Culture area of etched membrane: 44 cm²
- Membrane pore size: 0.4 µm 3.0 µm
- Material: Membrane: Polycarbonate (PC), The main body: Polystyrene (PS), Conforming to USP Class VI standards

**Features**

- The inserts paired with translucent PC membrane feature high pore density and are ideal for cell migration and invasion.
- PC membrane boasts strong chemical compatibility, making it compatible with most organic solvents and stains.
- Surface treated with TC, suitable for adhesion of various cell types.
- The suspended design positions the etched membrane approximately 1.5 mm from the insert bottom, preserving monolayer cells due to insert movement and preventing the loss of media due to capillary action.
- The inserts have three side openings design that facilitates easy access for tests and allows for gas exchange in the culture environment. These openings also allow standard pipettes be able to added or removed samples from the bottom compartment.
- Sterilized by irradiation, SAL 10⁶
- DNase/RNase-free, non-pyrogenic and non-cytotoxic

Cat. No.	Membrane Diameter (mm)	Culture Area (cm ²)	Membrane Pore Size (µm)	Membrane Material	Optical Properties	Recommended Working Volume (mL)		Sterile	Qty. Per Bag	Qty. Per Case
						Culture Dish	Insert			
TCS001100	75	44	0.4	PC	Translucent	13	9	Y	1	24
TCS002100	75	44	3.0	PC	Translucent	13	9	Y	1	24

Confocal Dishes

Confocal dishes, which are as convenient as 35 mm culture dishes and as advantageous as coverslips in terms of imaging, can provide the advanced optical performance required by high-magnification microscopes and confocal image analysis. They are used extensively in fluorescence microscopy, phase contrast microscopy, confocal microscopy, live cell imaging, differential interference contrast microscope, and fluorescence in situ hybridization (FISH).

- Apertures Specification: 15 mm 20 mm
- Surface: TC-treated
- Materials: Dish: Polystyrene (PS), Bottom: Borosilicate glass, conforming to USP Class VI standards

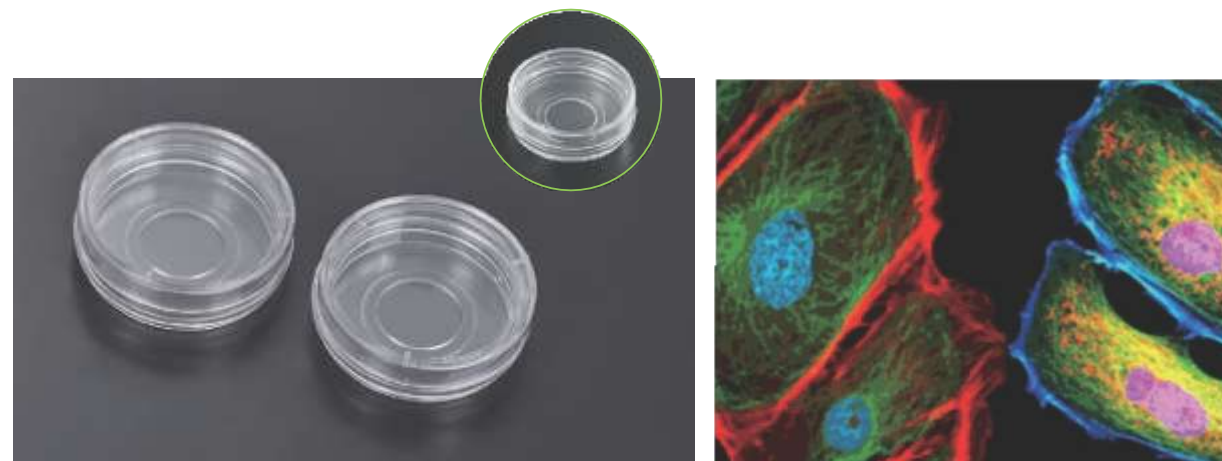

Features

- 2 apertures available: 15 mm and 20 mm; glass thickness: 0.16-0.19 mm
- The glass bottom is free of autofluorescence and deformation. Made of borosilicate, it is extremely hydrophilic and has good light permeability
- Suitable for fluorescence microscopy, laser scanning confocal microscopy, and phase contrast microscopy.
- Spliced with medical-grade traceless glue, bringing excellent transparency and facilitating cell observation
- Sterilized by irradiation, SAL 10⁶
- DNase/RNase-free, non-pyrogenic and non-cytotoxic

Confocal Dishes

Cat. No.	Aperture (mm)	Surface Type	Sterile	Qty. Per Bag	Qty. Per Case
BDD011035	15	TC-treated	Y	10	240
BDD012035	20		Y	10	240

CellSLIP® Coverslips

CellSLIP® Coverslips are a kind of laboratory consumables used for enabling adherent cells growth on certain solid surfaces (such as coverslips and glass slides) based on various experimental requirements. For scientific research involving a large number of test samples and multiple testing indicators, numerous cells are required for HE staining and immunohistochemical staining. However, many coverslips available on the market have some weaknesses. For instance, some coverslips are made of glass, which is fragile; other coverslips are designed without handles and are difficult to pick up. Cells may grow on the coverslips during the course of a culture. The culture dish with coverslips produced by JET BIOFIL (patent number: ZL201520113833.9, ZL201420594580.7, ZL201420594259. and ZL200610047607.0) solves the weaknesses of common coverslips and greatly facilitate experimental research and application.

- Specification of Culture Dish: 60 mm 100 mm
- Specification (diameter) of Coverslip: 8 mm 10 mm
- Number of Coverslips: 12 pcs 18 pcs 32 pcs 45 pcs
- Materials: Culture Dish: Polystyrene (PS), Coverslip: Polyethylene terephthalate (PET), conforming to USP Class VI standards

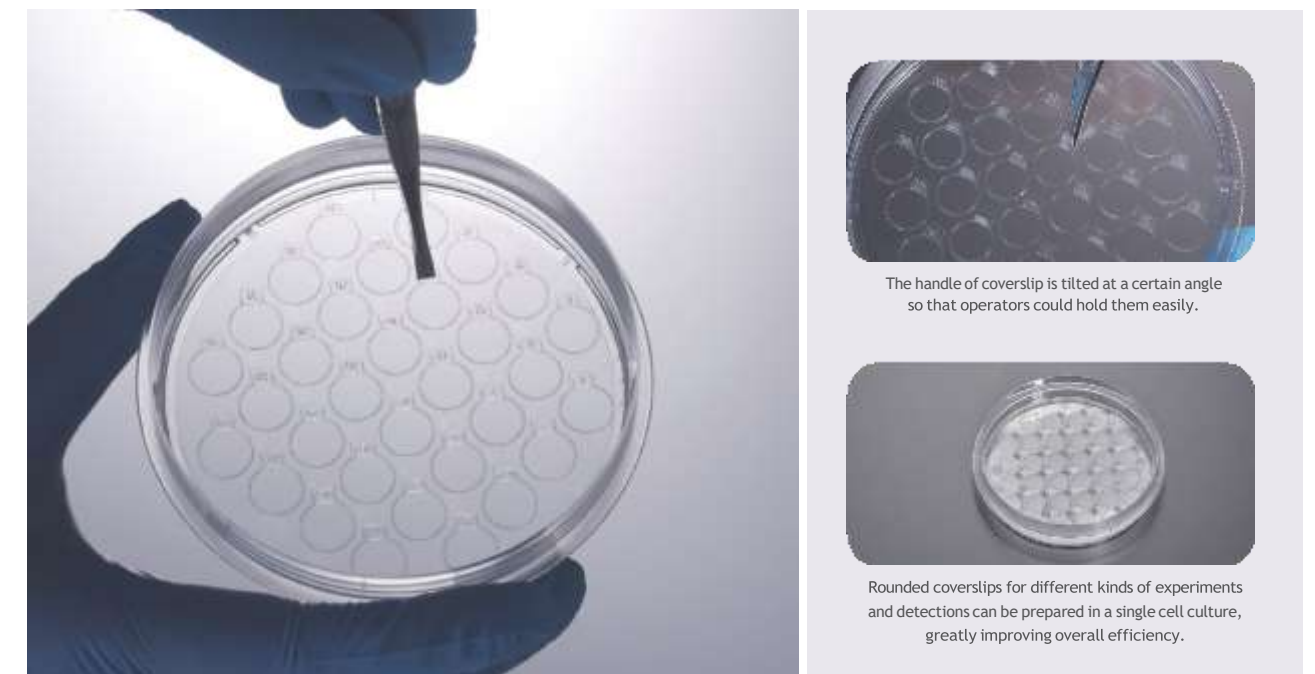

The handle of coverslip is tilted at a certain angle so that operators could hold them easily.

Rounded coverslips for different kinds of experiments and detections can be prepared in a single cell culture, greatly improving overall efficiency.

Features

- The coverslip is made of PET, that is strong and not fragile
- Excellent transparency and transmittance, making it possible to observe cells clearly under light microscopes and fluorescence microscopes
- Coverslips can be prepared for different kinds of tests in one experiment, greatly improving efficiency
- The handle of the coverslip is cocked at an angle so that operators can hold them easily; the handle is printed with a number for easy identification
- Sterilized by irradiation, SAL 10⁶
- DNase/RNase-free, non-pyrogenic and non-cytotoxic

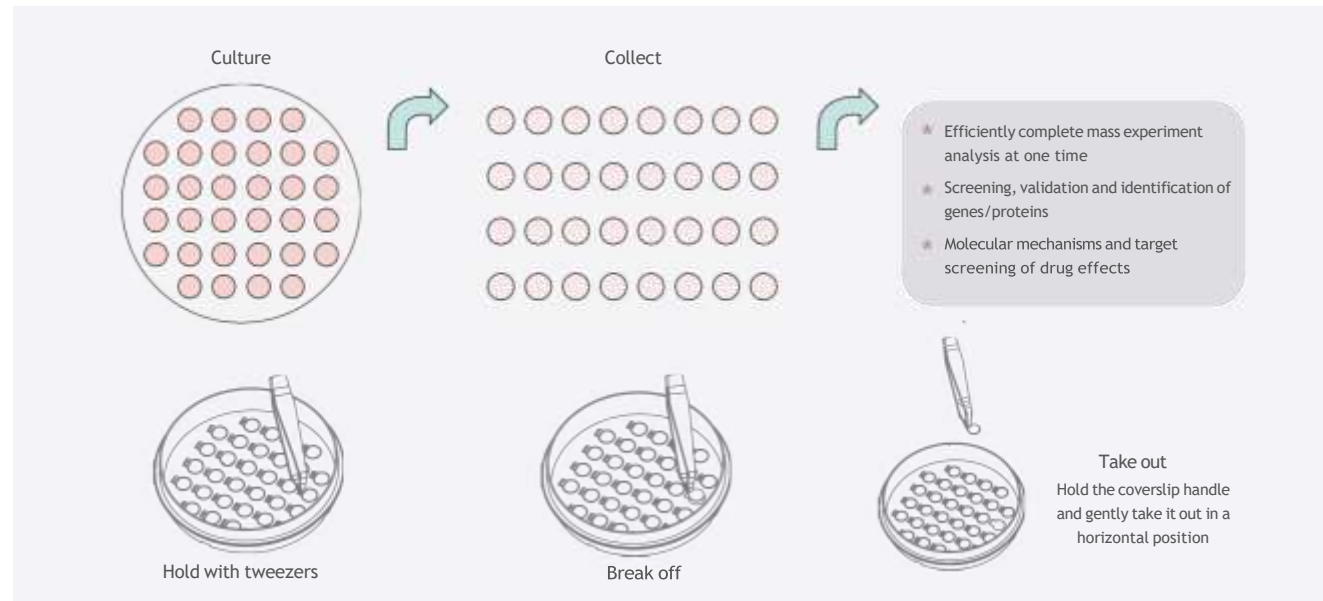

Coverslips

Cat. No.	Dish	Coverslip Qty.	Diameter (mm)	Apprx. Cell Growth Area (cm ²)-Single	Apprx. Cell Growth Area (cm ²)-Total	Plate	Qty. per Box	Qty. per Case
CXD206008	60 mm	18	8	0.5	9.0	48	1	48
CXD206010	60 mm	12	10	0.8	9.4	48	1	48
CXD310008	100 mm	45	8	0.5	22.5	48	1	48
CXD310010	100 mm	32	10	0.8	25.1	48	1	48

CellSCAFLD® 3D Cell Culture Scaffolds

The conventional cell culture is performed using 2D planes, and the growth model of 2D cell cultures is very different from the 3D environment in vivo. This causes significant differences in cellular morphology, cell differentiation, cell-matrix interaction and intercellular interaction when compared to the behavior under physiological conditions in vivo. A 3D cell culture provides an ideal simulated environment for an in vivo pattern of cell growth.

The 3D cell culture scaffold produced by JET BIOFIL (patent number: ZL201620728244.6, ZL201620728243.1 and 201510783345.3) is an ideal tool for studying 3D cell cultures, the mechanism of interaction between cells, cellular immunotherapy and stem cell therapy, drug screening, as well as drug production. Furthermore, it improves the cell culture area and increases the yield significantly.

This 3D cell culture scaffold can be used with 6, 12, 24 well culture plates and culture dishes of different sizes such as 35 mm, 60 mm and 70 mm.

Materials: Polystyrene (PS), conforming to USP Class VI standards

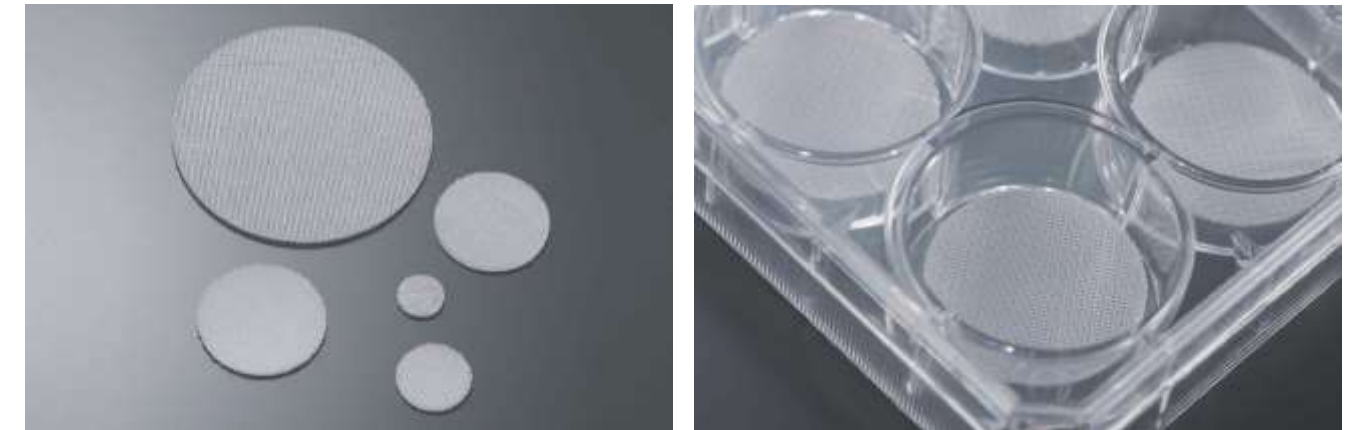

Features

- Average fiber diameter: 500µm; average spacing of wire column: 260 µm, with high regularity. The product consists of a 3D porous structure with good connectivity, facilitating the transmission of different nutritional ingredients in the course of the 3D cell culture, and ensuring the consistency of metabolic activity and accuracy of culture results
- In comparison to the 2D cell culture, the 3D cell culture allows for easier cell function expression since it simulates the 3D structure of human and animal cells to a maximum level and provides an ideal interactive environment between cells
- The 3D cell culture scaffold has a much larger culture surface area than conventional 2D cell culture products, thus saving on both space and material, and significantly improving cell culture efficiency and yield.
- Cells adhere strongly to the surface because of the advanced hydrophilic treatment
- No adsorption of cytokines or growth factors; cell and cell secretions can be directly isolated from the 3D scaffold when harvesting
- Sterilized by irradiation, SAL 10⁶
- DNase/RNase-free, non-pyrogenic and non-cytotoxic

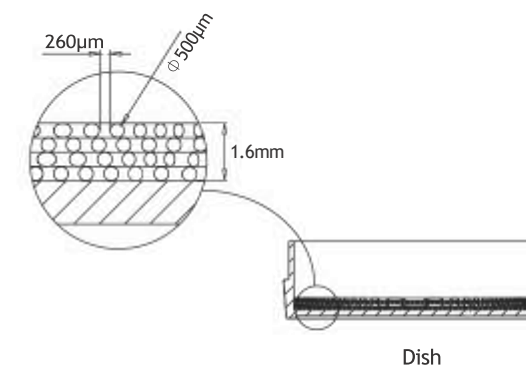

Average fiber diameter: 500 µm (FD); average spacing of fiber column: 260 µm (SP)

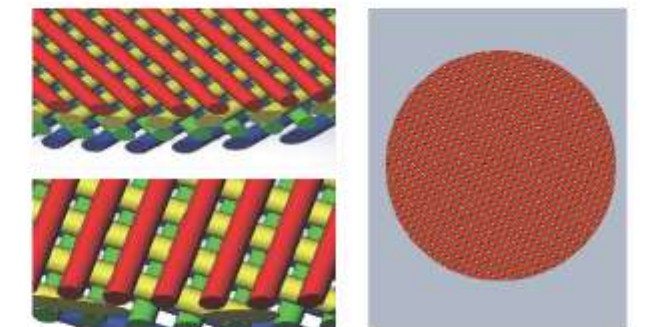

Structural diagram of the 3D cell culture scaffold: Every two layers of fiber form a crisscross pattern with a 90° angle, and every alternate layer consists of fibers that run parallel to one another.

Cat. No.	Type	Size (mm)	Fiber Diameter (µm)	Aperture (µm)	Number of Brackets/Box	Bracket Surface Area (cm ²)	Total Surface Area of the Stent (cm ²)	Characteristic	Qty. Per Box	Qty. Per Case
TDD032035	35 mm	32.0x1.6	500	260	1	43	43	The 3D scaffold has a four-layered three-dimensional structure with a highly hydrophilic surface for adherent culture.	1	40
TDD032060	60 mm	51.0x1.6	500	260	1	109	109		1	30
TDD032070	70 mm	67.5x1.6	500	260	1	191	191		1	30
TDP032006	6 Well	33.5x1.6	500	260	3	48	144		1	8
TDP032012	12 Well	21.0x1.6	500	260	6	19	114	The 3D scaffold is built into the culture plate well or culture dish.	1	8
TDP032024	24 Well	15.0x1.6	500	260	12	10	120		1	8

Bio-Reaction Tubes

Bio-reaction tubes are suitable for use in the high-throughput condition optimization process for suspension cell culture, including research and clonal selection of cell lines, culture medium optimization and recombinant protein development.

- Specification: 15 mL 50 mL 600 mL
- Bottom Type: Conical Self-standing
- Packaging: Re-sealable Bag Paper Rack
- Materials: Tube Body: Polypropylene (PP), Tube Cap: High-density Polyethylene (HDPE), Membrane: Polyvinylidene Difluoride (PVDF), conforming to USP Class VI standards



Features

- Available in various sizes, including 15/50/600 mL, with options for conical or self-standing bottoms
- Inner/outer surfaces of the tube are smooth with an even luster
- The white silk screen on 15 and 50 mL tubes can be used for recording experimental data
- Hydrophobic vent cap for continuous gas exchange
- Sterilized by irradiation, SAL 10⁻⁶
- DNase/RNase-free, non-pyrogenic and non-cytotoxic



Cat. No.	Volume (mL)	Bottom	Max RCF (xg)	Sterile	Package	Qty. Per Bag(Rack)	Qty. Per Case
BRT000015	15.0	Conical	12,000	Y	Re-sealable bag	10	100
BRT010015	15.0	Conical	12,000	Y	Paper rack	50	300
BRT000050	50.0	Conical	12,000	Y	Re-sealable bag	10	100
BRT010050	50.0	Conical	12,000	Y	Paper rack	25	300
BRT011050	50.0	Self-standing	6,000	Y	Re-sealable bag	10	100
BRT000600	600.0	Conical	6,000	Y	Re-sealable bag	1	32

Cat. No.	Volume (mL)	Speciality	Sterile	Qty. Per Bag	Qty. Per Case
BRC000050	50	Tube Cap	Y	25	1000

Culture Tubes

Culture tubes are primarily used to culture tissues and bacteria, to store clinical samples, including powder or liquid samples, and to conduct molecular biology tests, such as ELISA tests, RIA analysis and flow cytometry.

- Specification: 4 mL 5 mL 8 mL 14 mL
- Bottom Type: Round Conical
- Cap Type: Dual-position sealed type Plug-type
- Materials: Tube Body: Polypropylene (PP)/Polystyrene (PS), Tube Cap: Polyethylene (PE), conforming to USP Class VI standards



Features

- Four capacities: 4 mL, 5 mL, 8 mL and 14 mL
- Round and conical bottoms available
- Smooth inner and outer tube surfaces: PS for higher transparency, and PP for better chemical compatibility
- Dual-position sealed and plug caps are available: flexible operation with no sample loss.
- The 12x75 mm-long(5 mL) polystyrene round bottom tube is widely used in flow cytometry.
- Sterilized and non-sterilized available, sterilized by irradiation to SAL 10⁻⁶
- DNase/RNase-free, non-pyrogenic and non-cytotoxic

Cat. No.	Volume (mL)	Cap Style	Bottom	Material	Sterile	Qty. Per Bag	Qty. Per Case
TUB000004	4.0	Without cap	Conical	PP	N	1	1000
TUB010004	4.0	Without cap	Conical	PS	N	1	1000
TUB020004	4.0	Dual cap	Conical	PP	Y	25	500
TUB012004	4.0	Dual cap	Conical	PS	Y	25	500
TUB000005	5.0	Without cap	Round	PP	N	1	1000
TUB011005	5.0	Without cap	Round	PS	N	1	1000

Cat. No.	Volume (mL)	Cap Style	Bottom	Material	Sterile	Qty. Per Bag	Qty. Per Case
TUB022005	5.0	Plug cap	U-Bottom	PP	Y	25	500
TUB023005	5.0	Plug cap	U-Bottom	PS	Y	25	500
TUB025005	5.0	Dual cap	U-Bottom	PP	Y	25	500
TUB028005	5.0	Dual cap	U-Bottom	PS	Y	25	500
TUB000008	8.0	Without cap	U-Bottom	PP	N	1	1000
TUB010008	8.0	Without cap	U-Bottom	PS	N	1	1000
TUB002008	8.0	Without cap	U-Bottom	PP	Y	125	1000
TUB013008	8.0	Without cap	U-Bottom	PS	Y	125	1000
TUB002140	14.0	Without cap	U-Bottom	PP	N	1	1000
TUB004140	14.0	Without cap	U-Bottom	PS	N	1	1000
TUB100140	14.0	Dual cap	U-Bottom	PS	N	50	500
TUB111140	14.0	Dual cap	U-Bottom	PS	Y	25	500
TUB000140	14.0	Dual cap	U-Bottom	PP	N	50	500
TUB011140	14.0	Dual cap	U-Bottom	PP	Y	25	500

PS Centrifuge Tubes

PS centrifuge tubes are made of premium polystyrene (PS), offering greater transparency compared to PP material tubes, which makes it easier to observe the liquid inside the tube. These tubes are suitable for various laboratory applications such as low-speed centrifugation, sampling, dispensing, and storage of liquids in cell biology, immunology, microbiology, and molecular biology. They can also be used for cell culture.



- Specifications: 15 mL/50 mL Cap Type: Flat
- Bottom Type: Conical Packaging: Paper Rack/Plastic Rack/Bag
- Material: Tube Body: Polystyrene (PS), Tube Cap: High-density polyethylene (HDPE), Tube Rack: Polypropylene (PP), Cap Gasket: Polyethylene (PE), conforming to USP Class VI standards.

Features

- Tube bodies are made of premium PS material, providing high transparency that facilitates easy observation
- Tube body able to withstand weak acid and alkaline solutions
- Easy-to-read graduations and an accuracy within $\pm 2\%$
- Undergone rigorous sealing test to ensure no leakage occurs
- 15mL tube's cap comes with a leak-proof gasket
- Both tube racks for 15mL and 50mL are reusable after cleaning
- Maximum RCF: 3,000 \times g (15mL) 2,000 \times g (50mL)
- Recommended Working Temperature: 20°C-60°C
- Sterilized and non-sterilized available, sterilized by irradiation to SAL 10⁻⁶
- DNase/RNase-free, non-pyrogenic and non-cytotoxic

Cat.No	Volume (mL)	Bottom	Material	Sterile	Package	Qty. Per Bag (Rack)	Qty. Per Case
CFT721500	50.0	Conical	PS	Y	Plastic Rack	25	300
CFT410150	15.0	Conical	PS	N	Re-sealable Bag	50	500
CFT411150	15.0	Conical	PS	Y	Re-sealable Bag	25	500
CFT421150	15.0	Conical	PS	Y	Paper Rack	25	500
CFT721150	15.0	Conical	PS	Y	Plastic Rack	25	300

Note: PS tube bodies are not resistant to organic solvents, aromatic hydrocarbons, or chlorinated hydrocarbons, and cannot be sterilized with high temperature and pressure.

Cell Strainers

Cell strainers are suitable for the preparation of samples for flow cytometric analysis and single cell suspension of blood cells, the rapid separation of primary cultured cells and primary cells from tissues, etc., They are also suitable for prefiltration of solutions containing particles with a diameter greater than 40 μ m, and cleaning of cell suspension before cell subculture, counting, analysis or cryopreservation.

- Pore Size: 40 μ m 70 μ m 100 μ m
- Strainer Dimension:: ϕ 20.5 mm ϕ 30.7 mm
- Packaging: Blister Pack Paper Pack
- Materials: Frame: Polypropylene (PP), Bottom: Nylon mesh, conforming to USP Class VI standards



Features

- The bottom is made of an evenly distributed nylon mesh, providing reliable experimental results with consistency
- 40, 70 and 100 μ m pore sizes available with different colors for simple recognition
- The top extended edge can be operated aseptically with forceps
- Groove on the package for convenient access
- Molded polypropylene frame can be marked in different colors for easy handling and identification
- Suitable for JET BIOFIL's 50 mL centrifuge tubes and large-capacity conical centrifuge bottles
- Sterilized and non-sterilized available, sterilized by irradiation to SAL 10⁻⁶
- DNase/RNase-free, non-pyrogenic and non-cytotoxic

Individually Paper Blister Packed (suitable for Jet Biofil 50mL centrifuge tubes)

Cat. No.	Pore Size (μ m)	Bottom Outer Diameter (mm)	Strainer Diameter (mm)	Color	Sterile	Qty. Per Box	Qty. Per Case
CSS013040	40 (330 mesh)	25.5	20.5	Blue	Y	50	200
CSS013070	70 (220 mesh)	25.5	20.5	White	Y	50	200
CSS013100	100 (150 mesh)	25.5	20.5	Yellow	Y	50	200

Individually Blister Packed (suitable for Jet Biofil 250mL/225mL conical centrifuge bottles)

Cat. No.	Pore Size (µm)	Strainer Diameter (mm)	Bottom Outer Diameter (mm)	Color	Sterile	Qty. Per Box	Qty. Per Case
CSS014040	40 (330 mesh)	20.5	25.1	Blue	Y	50	200
CSS014070	70 (220 mesh)	20.5	25.1	White	Y	50	200
CSS014100	100 (150 mesh)	20.5	25.1	Yellow	Y	50	200

Individually Paper Plastic Bagged (suitable for Jet Biofil 500mL conical centrifuge bottles)

Cat. No.	Pore Size (µm)	Strainer Diameter (mm)	Bottom Outer Diameter (mm)	Color	Sterile	Qty. Per Box	Qty. Per Case
CSS015040	40 (330 mesh)	30.7	35.7	Blue	Y	50	200
CSS015070	70 (220 mesh)	30.7	35.7	White	Y	50	200
CSS015100	100 (150 mesh)	30.7	35.7	Yellow	Y	50	200

Individually Paper Blister Packed (suitable for Jet Biofil 500mL conical centrifuge bottles)

Cat. No.	Pore Size (µm)	Strainer Diameter (mm)	Bottom Outer Diameter (mm)	Color	Sterile	Qty. Per Box	Qty. Per Case
CSS025040	40 (330 mesh)	30.7	35.7	Blue	Y	50	200
CSS025070	70 (220 mesh)	30.7	35.7	White	Y	50	200
CSS025100	100 (150 mesh)	30.7	35.7	Yellow	Y	50	200

Small Cell Strainers

(Compatible with 1.5mL-15mL Centrifuge Tubes, Flow Cytometry Tubes and Culture Tubes)

The cell strainer is a sterile sieving device that quickly separates primary culture cells from cell clusters and tissues. It effectively removes cell aggregates or large particles from cell suspensions to ensure accurate subsequent experiments such as flow cytometry and cell sorting.

Jet Biofil's small cell strainers feature a split design with separate upper and lower cups, with a mesh diameter of 16.9mm, a lower cup inner diameter of 19.2mm, and a funnel outer diameter of 8.5mm. The upper cup of the small cell strainer is designed for filtration and collection, while the lower cup features a two-stage slot that enhances its compatibility. Additionally, the special venting spacers and air slots in the lower cup effectively prevent mesh clogging and liquid overflow.

- Pore Size: 40 µm 70 µm 100 µm
- Color: Blue White Yellow
- Materials: Frame: Polypropylene (PP), Bottom Mesh: Nylon, conforming to USP Class VI standards



Compatible Tubes/Bottles



Features

- Split Design: The innovative split design allows for the inverted collection of residual cells into the upper cup, effectively minimizing sample loss
- Wide compatibility: suitable for most centrifuge tubes, flow cytometry tubes, and culture tubes on the market with an inner diameter greater than 9mm and an outer diameter less than 19mm
- Strainers of different pore sizes can be stacked for one-step sequential filtration, enhancing efficiency
- The frame handle supports aseptic operation, reducing the risk of contamination during handling
- Special venting spacers and air slots in the lower cup prevent mesh clogging and liquid overflow, ensuring smooth filtration
- Evenly distributed nylon mesh bottom, providing consistent experimental results
- The easy-to-tear individual packaging facilitates sterile operation and prevents contamination
- Sterilized by irradiation to SAL 10⁻⁶; DNase/RNase-free, non-pyrogenic and non-cytotoxic

Cat. No.	Pore Size	Mesh Diameter (mm)	Lower Cup Diameter (mm)	Funnel Diameter (mm)	Upper Cup Capacity (mL)	Color	Sterile	Packaging	Qty. Per Box	Qty. Per Case
CSS016040	40 µm (330 mesh)	16.9	19.2	8.5	2.2	Blue	Y	Paper plastic bag	/	50
CSS016070	70 µm (220 mesh)	16.9	19.2	8.5	2.2	White	Y	Paper plastic bag	/	50
CSS016100	100 µm (150 mesh)	16.9	19.2	8.5	2.2	Yellow	Y	Paper plastic bag	/	50
CSS026040	40 µm (330 mesh)	16.9	19.2	8.5	2.2	Blue	Y	Blister packed	50	200
CSS026070	70 µm (220 mesh)	16.9	19.2	8.5	2.2	White	Y	Blister packed	50	200
CSS026100	100 µm (150 mesh)	16.9	19.2	8.5	2.2	Yellow	Y	Blister packed	50	200

Pestles for Cell Strainer

The cell strainer pestle consists of a handheld columnar pestle, a flat columnar grinding head, and a component for connecting the pestle to the grinding head. The convex design increases the contact area of the grinding head with the ground materials. It also increases frictional force during the grinding process so as to optimize the grinding effect.

- Materials: Polypropylene (PP), conforming to USP Class VI standards

Features

- Hard and wear-resistant PP
- Mesh lines at the bottom for optimized grinding effect
- Specially designed handle, slip-resistant and easy to hold
- Reduces sample loss when combined with the cell strainer
- Sterilized by irradiation, SAL 10⁻⁶
- DNase/RNase-free, non-pyrogenic and non-cytotoxic

Cat. No.	Length (mm)	Description	Sterile	Qty. Per Tray	Qty. Per Case
CSP001001	137.5	Pestle for Cell Strainer, Green, Individually Packaged	Y	1	100



Pestles for 1.5 mL Micro Centrifuge Tubes

The disposable pestles are made of high-quality PBT. They can be used in combination with 1.5 mL micro centrifuge tubes to finely grind soft tissue samples and to resuspend proteins, DNA, etc.

- Materials: Pestle: polybutylene terephthalate (PBT)
Microcentrifuge tube: polypropylene (PBT), conforming to USP Class VI standards



Features

- Made of high-quality PP, hard and wear resistant
- Specially designed handle is slip-proof and easy to hold
- Can be used in combination with 1.5 mL micro centrifuge tubes, facilitating fine sample grinding
- Sterilized by irradiation, SAL 10⁶
- Single independent package for easy operation
- DNase/RNase-free, non-pyrogenic and non-cytotoxic

Cat. No.	Length (mm)	Description	Sterile	Qty. Per Bag	Qty. Per Case
CSP001002	78	White, Individually packaged	Y	1	100
CSP002002	78	White, Bulk package	Y	100	1000
CSP003002	78	White, Pestle and Microtube Combo	Y	1	100

Rotatable Cell Scrapers

Rotatable Cell Scrapers: The blade angle of the cell scraper changes with a slight pressure on the handle using the forefinger, which pushes the handle downward towards the floor of the culture vessel.



- Length: 23 cm 30 cm
- Blade Specification: 12 mm 20 mm
- Materials: Blade: PE, Handle: ABS, conforming to USP Class VI standards

Features

- Available in 2 different lengths: 23 cm and 30 cm
- Rotating blade rotates in any required direction
- Full access to every corner
- Ribbed handle
- Individually wrapped
- Sterilized by irradiation, SAL 10⁶
- DNase/RNase-free, non-pyrogenic and non-cytotoxic

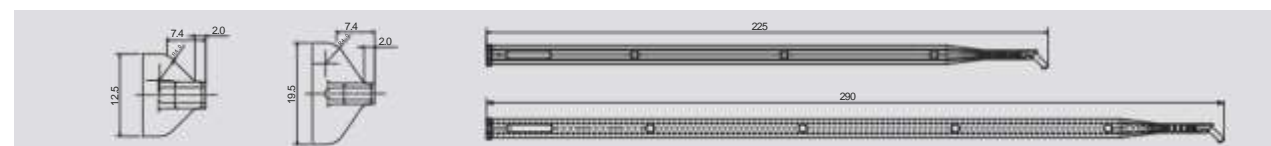

Cat. No.	Blade (mm)	Total Length (cm)	Material	Sterile	Qty. Per Bag	Qty. Per Case
CSC211023	12.5	23.0	Blades/PE; Handle/ABS	Y	1	150
CSC211030	19.5	30.0	Blades/PE; Handle/ABS	Y	1	150
CSC212023	19.5	23.0	Blades/PE; Handle/ABS	Y	1	150
CSC212030	12.5	30.0	Blades/PE; Handle/ABS	Y	1	150

Cell Scrapers

Cell Scrapers: The specially designed cell scraper features a turning function to ensure that an ideal angle is maintained during cell collection, which makes it convenient for manually harvesting adherent cells from culture vessels.



- Length: 14.0cm 25.0cm 39.0cm
- Blade Specification: 1.2cm 2.0cm 3.0cm
- Materials: Blade: TPE, Handle: ABS, conforming to USP Class VI standards

Features

- Two blade specifications available: scraper and lifter
- Specially designed to make the process of scraping and collecting cells easier and more effective
- Ultra-thin, flexible swivel blades are easy to use, reducing cell damage
- Easy removal and collection of cells using a scraping or lifting motion
- The 25 cm cell scraper is suitable for T25 and T75 culture flasks, while the 39 cm cell scraper is designed for other culture flasks/spinner bottles with higher capacities
- Individually wrapped
- Sterilized by irradiation, SAL 10⁶
- DNase/RNase-free, non-pyrogenic and non-cytotoxic

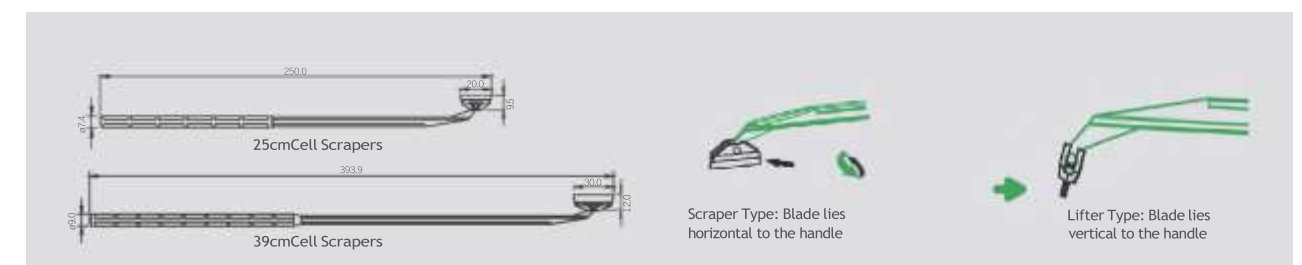

Cat. No.	Blade (mm)	Total Length (cm)	Material	Type	Sterile	Qty. Per Bag	Qty. Per Case
CSC011025	2.0	25.0	Blade/TPE; Handle/ABS	Scraper	Y	1	100
CSC012025	2.0	25.0	Blade/TPE; Handle/ABS	Lifter	Y	1	100
CSC011039	3.0	39.0	Blade/TPE; Handle/ABS	Scraper	Y	1	100
CSC012039	3.0	39.0	Blade/TPE; Handle/ABS	Lifter	Y	1	100
CSC011012	1.2	14.0	Blade/TPE; Handle/ABS	Scraper	Y	1	100
CSC012012	1.2	14.0	Blade/TPE; Handle/ABS	Lifter	Y	1	100

Cell Blade and Lifters

The cell blades, which are made of high quality polyethylene (PE), feature excellent toughness to protect cells during cell collection marking them best tool for cell collection in a laboratory.

- Width: 2.5 mm Narrow Blade 9.0 mm J-Hook
- Style: Exchangeable Non-exchangeable
- Color: White Green
- Materials: Polyethylene (PE), conforming to USP Class VI standards



Features

- Available in two different styles: 9.0 mm J-Hook and 2.5 mm Narrow Blade.
- Easy to operate, with a special blade design to minimize cell damage
- Spacious shovel blade design for easy and fast operation
- Unique dual-function design with a "scraper-type" structure at the other end to provide access to every hard-to-reach corner
- Sterilized by irradiation, SAL 10⁻⁶
- DNase/RNase-free, non-pyrogenic and non-cytotoxic

Cat. No.	Length (cm)	Width (mm)	Material	Color	Description	Sterile	Qty. Per Bag	Qty. Per Case
CSC012023	23.4	9.0	PE	White	J-Hook, Non-exchangeable	Y	1	100
CSC011023	23.4	2.5	PE	White	Narrow Blade, Non-exchangeable	Y	1	100
CSC013001	23.4	9.0	PE	Green	J-Hook, Exchangeable	Y	1	100
CSC013002	23.4	2.5	PE	Green	Narrow Blade, Exchangeable	Y	1	100

L-shaped Cell Spreader

L-shaped cell spreader is a ideal tool for achieving even cell or bacterial growth in a culture dish or culture plate.

- Spreader Handle Length: 145 mm
- Spreader Width: 37.5 mm
- Packaging: Bulk Individually Packed
- Materials: Polypropylene (PP), conforming to USP Class VI standards



Features

- Smooth surface to minimize scratches
- Upward tail design significantly reduces the risk of culture medium damage
- No need for high-temperature flame sterilization
- Sterilized by irradiation, SAL 10⁻⁶
- DNase/RNase-free, non-pyrogenic and non-cytotoxic

Cat. No.	Description	Qty. Per Bag	Qty. Per Case
CSP011014	PP, Individually Wrapped, Sterile	1	100
CSC012014	PP, 10 Per pack, Sterile	10	500

Cryogenic Vials

The cryogenic vials are made of transparent polypropylene (PP). By means of a special process, they have been manufactured to withstand ultra-low temperatures. Fully sealed to avoid leakage, the cryogenic vials are suitable for long-term cryopreservation of cells and tissues.



- Specification: 0.5 mL 1.5 mL 1.8 mL 2.0 mL 5.0 mL
- Cap Type: Flat Concave Tethered Concave
- Bottom Type: Conical Self-standing
- Cap Colors: Natural Red Pink Orange Blue Yellow Green Brown Black White
- Tube Colors: Natural Brown
- Insert Colors: Natural White Green Blue Orange Red Brown Yellow
- Materials: Tube Body: Polypropylene (PP), Tube Cap: High-density polyethylene (HDPE), Tube Cap: Polypropylene (PP), Cap Gasket: Thermoplastic Elastomer (TPE), conforming to USP Class VI standards



Features

- Available in various sizes and cap types to suit diverse application scenarios
- The tube is made of PP, that is smooth and transparent. It can resist ultra-low temperatures and withstand repeated freezing and thawing
- Tube body designed with both graduation and writing area for easy identification, observation and labeling
- Silica gel sealing washer inside the sealing cap eliminates liquid leakage
- Working temperature range: -196 °C (LN₂ gas phase) -121 °C
- Max. liquid storage volume for freezing: 80% of max. graduation
- Sterilized by irradiation, SAL 10⁻⁶
- DNase/RNase-free, non-pyrogenic and non-cytotoxic

0.5mL Cryogenic Vials with Flat Cap

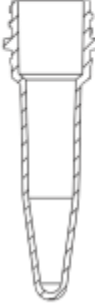
	Cat. No.	Capacity (mL)	Vial Color	Bottom	Lid Color	Graduation Line	Sterile	Package	Qty. Per Bag	Qty. Per Case
	FCT511005	0.5	Natural	Self-Standing	Natural	N	N	Bag	50	5000
	FCT511105	0.5	Natural	Self-Standing	Red	N	N	Bag	50	5000
	FCT511205	0.5	Natural	Self-Standing	Orange	N	N	Bag	50	5000
	FCT511305	0.5	Natural	Self-Standing	Blue	N	N	Bag	50	5000
	FCT511405	0.5	Natural	Self-Standing	Yellow	N	N	Bag	50	5000
	FCT511505	0.5	Natural	Self-Standing	Green	N	N	Bag	50	5000
	FCT511605	0.5	Natural	Self-Standing	Pink	N	N	Bag	50	5000
	FCT511705	0.5	Natural	Self-Standing	Brown	N	N	Bag	50	5000
	FCT511805	0.5	Natural	Self-Standing	White	N	N	Bag	50	5000
	FCT511905	0.5	Natural	Self-Standing	Black	N	N	Bag	50	5000
	FCT512005	0.5	Natural	Self-Standing	Natural	N	Y	Bag	50	5000
	FCT512105	0.5	Natural	Self-Standing	Red	N	Y	Bag	50	5000
	FCT512205	0.5	Natural	Self-Standing	Orange	N	Y	Bag	50	5000
	FCT512305	0.5	Natural	Self-Standing	Blue	N	Y	Bag	50	5000
	FCT512405	0.5	Natural	Self-Standing	Yellow	N	Y	Bag	50	5000
	FCT512505	0.5	Natural	Self-Standing	Green	N	Y	Bag	50	5000
	FCT512605	0.5	Natural	Self-Standing	Pink	N	Y	Bag	50	5000
	FCT512705	0.5	Natural	Self-Standing	Brown	N	Y	Bag	50	5000
	FCT512805	0.5	Natural	Self-Standing	White	N	Y	Bag	50	5000
	FCT512905	0.5	Natural	Self-Standing	Black	N	Y	Bag	50	5000
	FCT512005-1	0.5	Natural	Self-Standing	Natural	N	Y	Vial and Lid Separated	1000	5000
	FCT512105-1	0.5	Natural	Self-Standing	Red	N	Y	Vial and Lid Separated	1000	5000
	FCT512305-1	0.5	Natural	Self-Standing	Blue	N	Y	Vial and Lid Separated	1000	5000
	FCT512505-1	0.5	Natural	Self-Standing	Green	N	Y	Vial and Lid Separated	1000	5000
	FCT514005	0.5	Natural	Self-Standing	Green	N	Y	Vial and Lid Separated	500	5000
	FCT515005	0.5	Natural	Self-Standing	Red	N	Y	Vial and Lid Separated	500	5000
	FCT516005	0.5	Natural	Self-Standing	Natural	N	Y	Vial and Lid Separated	250	5000
	FCT516105	0.5	Natural	Self-Standing	Red	N	Y	Vial and Lid Separated	250	5000
	FCT516305	0.5	Natural	Self-Standing	Blue	N	Y	Vial and Lid Separated	250	5000
	FCT516405	0.5	Natural	Self-Standing	Yellow	N	Y	Vial and Lid Separated	250	5000
	FCT516505	0.5	Natural	Self-Standing	Green	N	Y	Vial and Lid Separated	250	5000
	FCT526705	0.5	Brown	Self-Standing	Brown	N	Y	Vial and Lid Separated	250	5000
	FCT611005	0.5	Natural	Conical	Natural	N	N	Bag	50	5000
	FCT611105	0.5	Natural	Conical	Red	N	N	Bag	50	5000
	FCT611205	0.5	Natural	Conical	Orange	N	N	Bag	50	5000
	FCT611305	0.5	Natural	Conical	Blue	N	N	Bag	50	5000
	FCT611405	0.5	Natural	Conical	Yellow	N	N	Bag	50	5000
	FCT611505	0.5	Natural	Conical	Green	N	N	Bag	50	5000
	FCT611605	0.5	Natural	Conical	Pink	N	N	Bag	50	5000
	FCT611705	0.5	Natural	Conical	Brown	N	N	Bag	50	5000
	FCT611805	0.5	Natural	Conical	White	N	N	Bag	50	5000
	FCT611905	0.5	Natural	Conical	Black	N	N	Bag	50	5000
	FCT612005	0.5	Natural	Conical	Natural	N	Y	Bag	50	5000
	FCT612105	0.5	Natural	Conical	Red	N	Y	Bag	50	5000
	FCT612205	0.5	Natural	Conical	Orange	N	Y	Bag	50	5000
	FCT612305	0.5	Natural	Conical	Blue	N	Y	Bag	50	5000
	FCT612405	0.5	Natural	Conical	Yellow	N	Y	Bag	50	5000
	FCT612505	0.5	Natural	Conical	Green	N	Y	Bag	50	5000
	FCT612605	0.5	Natural	Conical	Pink	N	Y	Bag	50	5000
	FCT612705	0.5	Natural	Conical	Brown	N	Y	Bag	50	5000
	FCT612805	0.5	Natural	Conical	White	N	Y	Bag	50	5000
	FCT612905	0.5	Natural	Conical	Black	N	Y	Bag	50	5000

1.5mL Cryogenic Vials with Flat Cap

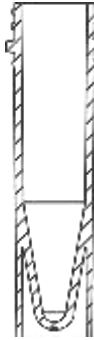
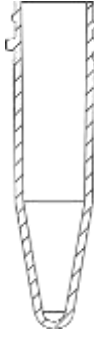
	Cat. No.	Capacity (mL)	Vial Color	Bottom	Lid Color	Graduation Line	Sterile	Package	Qty. Per Bag	Qty. Per Case
	FCT511015	1.5	Natural	Self-Standing	Natural	N	N	Bag	50	5000
	FCT511115	1.5	Natural	Self-Standing	Red	N	N	Bag	50	5000
	FCT511215	1.5	Natural	Self-Standing	Orange	N	N	Bag	50	5000
	FCT511315	1.5	Natural	Self-Standing	Blue	N	N	Bag	50	5000
	FCT511415	1.5	Natural	Self-Standing	Yellow	N	N	Bag	50	5000
	FCT511515	1.5	Natural	Self-Standing	Green	N	N	Bag	50	5000
	FCT511615	1.5	Natural	Self-Standing	Pink	N	N	Bag	50	5000
	FCT511715	1.5	Natural	Self-Standing	Brown	N	N	Bag	50	5000
	FCT511815	1.5	Natural	Self-Standing	White	N	N	Bag	50	5000
	FCT511915	1.5	Natural	Self-Standing	Black	N	N	Bag	50	5000
	FCT512015	1.5	Natural	Self-Standing	Natural	N	Y	Bag	50	5000
	FCT512115	1.5	Natural	Self-Standing	Red	N	Y	Bag	50	5000
	FCT512215	1.5	Natural	Self-Standing	Orange	N	Y	Bag	50	5000
	FCT512315	1.5	Natural	Self-Standing	Blue	N	Y	Bag	50	5000
	FCT512415	1.5	Natural	Self-Standing	Yellow	N	Y	Bag	50	5000
	FCT512515	1.5	Natural	Self-Standing	Green	N	Y	Bag	50	5000
	FCT512615	1.5	Natural	Self-Standing	Pink	N	Y	Bag	50	5000
	FCT512715	1.5	Natural	Self-Standing	Brown	N	Y	Bag	50	5000
	FCT512815	1.5	Natural	Self-Standing	White	N	Y	Bag	50	5000
	FCT512915	1.5	Natural	Self-Standing	Black	N	Y	Bag	50	5000
	FCT522815	1.5	Natural	Self-Standing	White	N	Y	Bag	500	5000
	FCT516015	1.5	Natural	Self-Standing	Natural	N	Y	Vial and Lid Separated	250	5000
	FCT516115	1.5	Natural	Self-Standing	Red	N	Y	Vial and Lid Separated	250	5000
	FCT516215	1.5	Natural	Self-Standing	Orange	N	Y	Vial and Lid Separated	250	5000
	FCT516315	1.5	Natural	Self-Standing	Blue	N	Y	Vial and Lid Separated	250	5000
	FCT516415	1.5	Natural	Self-Standing	Yellow	N	Y	Vial and Lid Separated	250	5000
	FCT516515	1.5	Natural	Self-Standing	Green	N	Y	Vial and Lid Separated	250	5000
	FCT516615	1.5	Natural	Self-Standing	Pink	N	Y	Vial and Lid Separated	250	5000
	FCT516715	1.5	Natural	Self-Standing	Brown	N	Y	Vial and Lid Separated	250	5000
	FCT516815	1.5	Natural	Self-Standing	White	N	Y	Vial and Lid Separated	250	5000
	FCT516915	1.5	Natural	Self-Standing	Black	N	Y	Vial and Lid Separated	250	5000
	FCT526715	1.5	Brown	Self-Standing	Brown	N	Y	Vial and Lid Separated	250	5000
	FCT611015	1.5	Natural	Conical	Natural	Y	N	Bag	50	5000
	FCT611115	1.5	Natural	Conical	Red	Y	N	Bag	50	5000
	FCT611215	1.5	Natural	Conical	Orange	Y	N	Bag	50	5000
	FCT611315	1.5	Natural	Conical	Blue	Y	N	Bag	50	5000
	FCT611415	1.5	Natural	Conical	Yellow	Y	N	Bag	50	5000
	FCT611515	1.5	Natural	Conical	Green	Y	N	Bag	50	5000
	FCT611615	1.5	Natural	Conical	Pink	Y	N	Bag	50	5000
	FCT611715	1.5	Natural	Conical	Brown	Y	N	Bag	50	5000
	FCT611815	1.5	Natural	Conical	White	Y	N	Bag	50	5000
	FCT611915	1.5	Natural	Conical	Black	Y	N	Bag	50	5000
	FCT613015	1.5	Natural	Conical	Natural	Y	N	Vial and Lid Separated	500	5000
	FCT614015	1.5	Natural	Conical	Red	Y	N	Vial and Lid Separated	500	5000
	FCT615015	1.5	Natural	Conical	Yellow	Y	N	Vial and Lid Separated	500	5000
	FCT616015	1.5	Natural	Conical	Blue	Y	N	Vial and Lid Separated	500	5000
	FCT617015	1.5	Natural	Conical	Green	Y	N	Vial and Lid Separated	500	5000
	FCT618015	1.5	Natural	Conical	Brown	Y	N	Vial and Lid Separated	500	5000
	FCT612015	1.5	Natural	Conical	Natural	Y	Y	Bag	50	5000
	FCT612115	1.5	Natural	Conical	Red	Y	Y	Bag	50	5000
	FCT612215	1.5	Natural	Conical	Orange	Y	Y	Bag	50	5000
	FCT612315	1.5	Natural	Conical	Blue	Y	Y	Bag	50	5000
	FCT612415	1.5	Natural	Conical	Yellow	Y	Y	Bag	50	5000
	FCT612515	1.5	Natural	Conical	Green	Y	Y	Bag	50	5000
	FCT612615	1.5	Natural	Conical	Pink	Y	Y	Bag	50	5000
	FCT612715	1.5	Natural	Conical	Brown	Y	Y	Bag	50	5000
	FCT612815	1.5	Natural	Conical	White	Y	Y	Bag	50	5000

Cat. No.	Capacity (mL)	Vial Color	Bottom	Lid Color	Graduation Line	Sterile	Package	Qty. Per Bag	Qty. Per Case
FCT612915	1.5	Natural	Conical	Black	Y	Y	Bag	50	5000
FCT622015	1.5	Natural	Conical	Natural	Y	Y	Bag	500	5000

1.8mL Cryogenic Vials with Flat Cap

Cat. No.	Capacity (mL)	Vial Color	Bottom	Lid Color	Graduation Line	Sterile	Package	Qty. Per Bag	Qty. Per Case
FCT001018	1.8	Natural	Self-Standing	Red	Y	Y	Bag	20	5000

2.0mL Cryogenic Vials with Flat Cap

Cat. No.	Capacity (mL)	Vial Color	Bottom	Lid Color	Graduation Line	Sterile	Package	Qty. Per Bag	Qty. Per Case
FCT511020	2.0	Natural	Self-Standing	Natural	Y	N	Bag	50	5000
FCT511120	2.0	Natural	Self-Standing	Red	Y	N	Bag	20	5000
FCT511220	2.0	Natural	Self-Standing	Orange	Y	N	Bag	20	5000
FCT511320	2.0	Natural	Self-Standing	Blue	Y	N	Bag	20	5000
FCT511420	2.0	Natural	Self-Standing	Yellow	Y	N	Bag	20	5000
FCT511520	2.0	Natural	Self-Standing	Green	Y	N	Bag	20	5000
FCT511620	2.0	Natural	Self-Standing	Pink	Y	N	Bag	20	5000
FCT511720	2.0	Natural	Self-Standing	Brown	Y	N	Bag	20	5000
FCT511820	2.0	Natural	Self-Standing	White	Y	N	Bag	20	5000
FCT511920	2.0	Natural	Self-Standing	Black	Y	N	Bag	20	5000
FCT511820-1	2.0	Natural	Self-Standing	White	Y	N	Vial and Lid Separated	1000	5000
FCT512020	2.0	Natural	Self-Standing	Natural	Y	Y	Bag	20	5000
FCT512120	2.0	Natural	Self-Standing	Red	Y	Y	Bag	20	5000
FCT512220	2.0	Natural	Self-Standing	Orange	Y	Y	Bag	20	5000
FCT512320	2.0	Natural	Self-Standing	Blue	Y	Y	Bag	20	5000
FCT512420	2.0	Natural	Self-Standing	Yellow	Y	Y	Bag	20	5000
FCT512520	2.0	Natural	Self-Standing	Green	Y	Y	Bag	20	5000
FCT512620	2.0	Natural	Self-Standing	Pink	Y	Y	Bag	20	5000
FCT512720	2.0	Natural	Self-Standing	Brown	Y	Y	Bag	20	5000
FCT512820	2.0	Natural	Self-Standing	White	Y	Y	Bag	20	5000
FCT512920	2.0	Natural	Self-Standing	Black	Y	Y	Bag	20	5000
FCT522020	2.0	Natural	Self-Standing	Natural	Y	Y	Bag	500	5000
FCT522120	2.0	Natural	Self-Standing	Red	Y	Y	Bag	500	5000
FCT522320	2.0	Natural	Self-Standing	Blue	Y	Y	Bag	500	5000
FCT811020	2.0	Natural	Self-Standing	Purple	Y	Y	Bag	500	5000
FCT512020-1	2.0	Natural	Self-Standing	Natural	Y	Y	Vial and Lid Separated	1000	5000
FCT512120-1	2.0	Brown	Self-Standing	Red	Y	Y	Vial and Lid Separated	1000	5000
FCT512320-1	2.0	Natural	Self-Standing	Blue	Y	Y	Vial and Lid Separated	1000	5000
FCT512420-1	2.0	Natural	Self-Standing	Yellow	Y	Y	Vial and Lid Separated	1000	5000
FCT512520-1	2.0	Natural	Self-Standing	Green	Y	Y	Vial and Lid Separated	1000	5000
FCT614020	2.0	Natural	Self-Standing	Natural	Y	Y	Vial and Lid Separated	500	5000
FCT711020	2.0	Natural	Self-Standing	Yellow	Y	Y	Vial and Lid Separated	500	5000
FCT712020	2.0	Natural	Self-Standing	Green	Y	Y	Vial and Lid Separated	500	5000
FCT713020	2.0	Natural	Self-Standing	Red	Y	Y	Vial and Lid Separated	500	5000
FCT714020	2.0	Natural	Self-Standing	White	Y	Y	Vial and Lid Separated	500	5000
FCT715020	2.0	Natural	Self-Standing	Pink	Y	Y	Vial and Lid Separated	500	5000
FCT716020	2.0	Natural	Self-Standing	Orange	Y	Y	Vial and Lid Separated	500	5000
FCT717020	2.0	Natural	Self-Standing	Black	Y	Y	Vial and Lid Separated	500	5000
FCT718020	2.0	Natural	Self-Standing	Blue	Y	Y	Vial and Lid Separated	500	5000
FCT516220	2.0	Natural	Self-Standing	Orange	Y	Y	Vial and Lid Separated	250	5000
FCT516320	2.0	Natural	Self-Standing	Blue	Y	Y	Vial and Lid Separated	250	5000
FCT516820	2.0	Natural	Self-Standing	White	Y	Y	Vial and Lid Separated	250	5000
FCT526720	2.0	Natural	Self-Standing	Brown	N	Y	Vial and Lid Separated	250	5000
FCT611020	2.0	Natural	Conical	Natural	Y	N	Bag	20	5000
FCT611120	2.0	Natural	Conical	Red	Y	N	Bag	20	5000
FCT611220	2.0	Natural	Conical	Orange	Y	N	Bag	20	5000

Cat. No.	Capacity (mL)	Vial Color	Bottom	Lid Color	Graduation Line	Sterile	Package	Qty. Per Bag	Qty. Per Case
FCT611320	2.0	Natural	Conical	Blue	Y	N	Bag	20	5000
FCT611420	2.0	Natural	Conical	Yellow	Y	N	Bag	20	5000
FCT611520	2.0	Natural	Conical	Green	Y	N	Bag	20	5000
FCT611620	2.0	Natural	Conical	Pink	Y	N	Bag	20	5000
FCT611720	2.0	Natural	Conical	Brown	Y	N	Bag	20	5000
FCT611820	2.0	Natural	Conical	White	Y	N	Bag	20	5000
FCT611920	2.0	Natural	Conical	Black	Y	N	Bag	20	5000
FCT613020	2.0	Natural	Conical	Natural	Y	N	Vial and Lid Separated	500	5000
FCT612020	2.0	Natural	Conical	Natural	Y	Y	Bag	20	5000
FCT612120	2.0	Natural	Conical	Red	Y	Y	Bag	20	5000
FCT612220	2.0	Natural	Conical	Orange	Y	Y	Bag	20	5000
FCT612320	2.0	Natural	Conical	Blue	Y	Y	Bag	20	5000
FCT612420	2.0	Natural	Conical	Yellow	Y	Y	Bag	20	5000
FCT612520	2.0	Natural	Conical	Green	Y	Y	Bag	20	5000
FCT612620	2.0	Natural	Conical	Pink	Y	Y	Bag	20	5000
FCT612720	2.0	Natural	Conical	Brown	Y	Y	Bag	20	5000
FCT612820	2.0	Natural	Conical	White	Y	Y	Bag	20	5000
FCT612920	2.0	Natural	Conical	Black	Y	Y	Bag	20	5000

5.0mL Cryogenic Vials with Flat Cap

Cat. No.	Capacity (mL)	Vial Color	Bottom	Lid Color	O-Shaped Seal	Graduation Line	Sterile	Package	Qty. Per Bag	Qty. Per Case
FCT001150	5.0	Natural	Self-Standing	Green	Y	Y	Y	Bag	50	500
FCT001050	5.0	Natural	Self-Standing	Green	N	Y	Y	Bag	50	500
FCT002050	5.0	Natural	Self-Standing	Red	N	Y	Y	Bag	20	2500
FCT003050	5.0	Natural	Self-Standing	Green	N	Y	N	Vial and Lid Separated	2500	2500
FCT013050	5.0	Natural	Self-Standing	Green	N	Y	Y	Vial and Lid Separated	Lid:500 Vial:100	2500

0.5mL Cryogenic Vials with Concave Cap

Cat. No.	Capacity (mL)	Vial Color	Bottom	Lid Color	Graduation Line	Sterile	Package	Qty. Per Bag	Qty. Per Case
FCT110005	0.5	Natural	Self-Standing	Natural	N	N	Box	100	1000
FCT111005	0.5	Natural	Self-Standing	Natural	N	Y	Box	100	1000
FCT362105	0.5	Natural	Self-Standing	Red	N	Y	Box	100	1000
FCT362305	0.5	Natural	Self-Standing	Blue	N	Y	Box	100	1000
FCT362405	0.5	Natural	Self-Standing	Yellow	N	Y	Box	100	1000
FCT362505	0.5	Natural	Self-Standing	Green	N	Y	Box	100	1000
FCT362605	0.5	Natural	Self-Standing	Pink	N	Y	Box	100	1000
FCT362805	0.5	Natural	Self-Standing	White	N	Y	Box	100	1000
FCT311005	0.5	Natural	Self-Standing	Natural	N	N	Box	50	5000
FCT311105	0.5	Natural	Self-Standing	Red	N	N	Bag	50	5000
FCT311305	0.5	Natural	Self-Standing	Blue	N	N	Bag	50	5000
FCT311405	0.5	Natural	Self-Standing	Yellow	N	N	Bag	50	5000
FCT311505	0.5	Natural	Self-Standing	Green	N	N	Bag	50	5000
FCT311605	0.5	Natural	Self-Standing	Pink	N	N	Bag	50	5000
FCT311705	0.5	Natural	Self-Standing	Brown	N	N	Bag	50	5000
FCT311805	0.5	Natural	Self-Standing	White	N	N	Bag	50	5000
FCT311905	0.5	Natural	Self-Standing	Black	N	N	Bag	50	5000
FCT312005	0.5	Natural	Self-Standing	Natural	N	Y	Bag	50	5000
FCT312105	0.5	Natural	Self-Standing	Red	N	Y	Bag	50	5000
FCT312305	0.5	Natural	Self-Standing	Blue	N	Y	Bag	50	5000
FCT312405	0.5	Natural	Self-Standing	Yellow	N	Y	Bag	50	5000
FCT312505	0.5	Natural	Self-Standing	Green	N	Y	Bag	50	5000
FCT312605	0.5	Natural	Self-Standing	Pink	N	Y	Bag	50	5000
FCT312705	0.5	Natural	Self-Standing	Brown	N	Y	Bag	50	5000
FCT312805	0.5	Natural	Self-Standing	White	N	Y	Bag	50	5000
FCT312905	0.5	Natural	Self-Standing	Black	N	Y	Bag	50	5000

	Cat. No.	Capacity (mL)	Vial Color	Bottom	Lid Color	Graduation Line	Sterile	Package	Qty. Per Bag	Qty. Per Case
	FCT310005	0.5	Brown	Self-Standing	Natural	N	N	Bag	500	5000
	FCT311205	0.5	Natural	Self-Standing	Natural	N	Y	Bag	500	5000
	FCT510905	0.5	Brown	Self-Standing	Brown	N	N	Bag	500	5000
	FCT513905	0.5	Brown	Self-Standing	Brown	N	Y	Bag	500	5000
	FCT001005	0.5	Natural	Self-Standing	Natural	N	Y	Bag	50	5000
	FCT315705	0.5	Natural	Self-Standing	Brown	N	Y	Vial and Lid Separated	250	5000
	FCT315805	0.5	Natural	Self-Standing	White	N	Y	Vial and Lid Separated	250	5000
	FCT010005	0.5	Natural	Conical	Natural	N	N	Box	100	1000
	FCT011005	0.5	Natural	Conical	Natural	N	Y	Box	100	1000
	FCT112005	0.5	Natural	Conical	Natural	N	N	Bag	50	5000
	FCT122005	0.5	Natural	Conical	Natural	N	Y	Bag	50	5000
	FCT412905	0.5	Brown	Conical	Brown	N	N	Bag	50	5000
	FCT422905	0.5	Brown	Conical	Brown	N	Y	Bag	50	5000
	FCT210005	0.5	Natural	Conical	Natural	N	N	Bag	500	5000
	FCT410905	0.5	Brown	Conical	Brown	N	N	Bag	500	5000
	FCT411905	0.5	Brown	Conical	Brown	N	Y	Bag	500	5000
	FCT002005	0.5	Natural	Conical	Natural	N	Y	Bag	50	5000

1.5mL Cryogenic Vials with Concave Cap

	Cat. No.	Capacity (mL)	Vial Color	Bottom	Lid Color	Graduation Line	Sterile	Package	Qty. Per Bag	Qty. Per Case
	FCT110015	1.5	Natural	Self-Standing	Natural	N	N	Box	100	1000
	FCT111015	1.5	Natural	Self-Standing	Natural	N	Y	Box	100	1000
	FCT362115	1.5	Natural	Self-Standing	Red	N	Y	Box	100	1000
	FCT362315	1.5	Natural	Self-Standing	Blue	N	Y	Box	100	1000
	FCT362415	1.5	Natural	Self-Standing	Yellow	N	Y	Box	100	1000
	FCT362515	1.5	Natural	Self-Standing	Green	N	Y	Box	100	1000
	FCT362615	1.5	Natural	Self-Standing	Pink	N	Y	Box	100	1000
	FCT362815	1.5	Natural	Self-Standing	White	N	Y	Box	100	1000
	FCT311015	1.5	Natural	Self-Standing	Natural	N	N	Bag	50	5000
	FCT311115	1.5	Natural	Self-Standing	Red	N	N	Bag	50	5000
	FCT311315	1.5	Natural	Self-Standing	Blue	N	N	Bag	50	5000
	FCT311415	1.5	Natural	Self-Standing	Yellow	N	N	Bag	50	5000
	FCT311515	1.5	Natural	Self-Standing	Green	N	N	Bag	50	5000
	FCT311615	1.5	Natural	Self-Standing	Pink	N	N	Bag	50	5000
	FCT311715	1.5	Natural	Self-Standing	Brown	N	N	Bag	50	5000
	FCT311815	1.5	Natural	Self-Standing	White	N	N	Bag	50	5000
	FCT311915	1.5	Natural	Self-Standing	Black	N	N	Bag	50	5000
	FCT312015	1.5	Natural	Self-Standing	Natural	N	Y	Bag	50	5000
	FCT312115	1.5	Natural	Self-Standing	Red	N	Y	Bag	50	5000
	FCT312315	1.5	Natural	Self-Standing	Blue	N	Y	Bag	50	5000
	FCT312415	1.5	Natural	Self-Standing	Yellow	N	Y	Bag	50	5000
	FCT312515	1.5	Natural	Self-Standing	Green	N	Y	Bag	50	5000
	FCT312615	1.5	Natural	Self-Standing	Pink	N	Y	Bag	50	5000
	FCT312715	1.5	Natural	Self-Standing	Brown	N	Y	Bag	50	5000
	FCT312815	1.5	Natural	Self-Standing	White	N	Y	Bag	50	5000
	FCT312915	1.5	Natural	Self-Standing	Black	N	Y	Bag	50	5000
	FCT310015	1.5	Brown	Self-Standing	Natural	N	N	Bag	500	5000
	FCT311215	1.5	Natural	Self-Standing	Natural	N	Y	Bag	500	5000
	FCT510915	1.5	Brown	Self-Standing	Brown	N	N	Bag	500	5000
	FCT513915	1.5	Brown	Self-Standing	Brown	N	Y	Bag	500	5000
	FCT001015	1.5	Natural	Self-Standing	Natural	N	Y	Bag	50	5000
	FCT315015	1.5	Natural	Self-Standing	Natural	N	Y	Vial and Lid Separated	250	5000
	FCT315115	1.5	Natural	Self-Standing	Red	N	Y	Vial and Lid Separated	250	5000
	FCT315315	1.5	Natural	Self-Standing	Blue	N	Y	Vial and Lid Separated	250	5000
	FCT315415	1.5	Natural	Self-Standing	Yellow	N	Y	Vial and Lid Separated	250	5000
	FCT315515	1.5	Natural	Self-Standing	Green	N	Y	Vial and Lid Separated	250	5000
	FCT315615	1.5	Natural	Self-Standing	Pink	N	Y	Vial and Lid Separated	250	5000

	Cat. No.	Capacity (mL)	Vial Color	Bottom	Lid Color	Graduation Line	Sterile	Package	Qty. Per Bag	Qty. Per Case
	FCT010015	1.5	Natural	Conical	Natural	Y	N	Box	100	1000
	FCT011015	1.5	Natural	Conical	Natural	Y	Y	Box	100	1000
	FCT112015	1.5	Natural	Conical	Natural	Y	N	Bag	50	5000
	FCT122015	1.5	Natural	Conical	Natural	Y	Y	Bag	50	5000
	FCT412915	1.5	Brown	Conical	Brown	Y	N	Bag	50	5000
	FCT422915	1.5	Brown	Conical	Brown	Y	Y	Bag	50	5000
	FCT210015	1.5	Natural	Conical	Natural	Y	N	Bag	500	5000
	FCT410915	1.5	Brown	Conical	Brown	Y	N	Bag	500	5000
	FCT411915	1.5	Brown	Conical	Brown	Y	Y	Bag	500	5000

2.0mL Cryogenic Vials with Concave Cap

	Cat. No.	Capacity (mL)	Vial Color	Bottom	Lid Color	Graduation Line	Sterile	Package	Qty. Per Bag	Qty. Per Case
	FCT110020	2.0	Natural	Self-Standing	Natural	Y	N	Box	100	1000
	FCT111020	2.0	Natural	Self-Standing	Natural	Y	Y	Box	100	1000
	FCT111120	2.0	Natural	Self-Standing	Red	Y	Y	Box	100	1000
	FCT111320	2.0	Natural	Self-Standing	Blue	Y	Y	Box	100	1000
	FCT111420	2.0	Natural	Self-Standing	Yellow	Y	Y	Box	100	1000
	FCT111520	2.0	Natural	Self-Standing	Green	Y	Y	Box	100	1000
	FCT111620	2.0	Natural	Self-Standing	Pink	Y	Y	Box	100	1000
	FCT111820	2.0	Natural	Self-Standing	White	Y	Y	Box	100	1000
	FCT311020	2.0	Natural	Self-Standing	Natural	Y	N	Bag	20	5000
	FCT311120	2.0	Natural	Self-Standing	Red	Y	N	Bag	20	5000
	FCT311320	2.0	Natural	Self-Standing	Blue	Y	N	Bag	20	5000
	FCT311420	2.0	Natural	Self-Standing	Yellow	Y	N	Bag	20	5000
	FCT311520	2.0	Natural	Self-Standing	Green	Y	N	Bag	20	5000
	FCT311620	2.0	Natural	Self-Standing	Pink	Y	N	Bag	20	5000
	FCT311720	2.0	Natural	Self-Standing	Brown	Y	N	Bag	20	5000
	FCT311820	2.0	Natural	Self-Standing	White	Y	N	Bag	20	5000
	FCT311920	2.0	Natural	Self-Standing	Black	Y	N	Bag	20	5000
	FCT312020	2.0	Natural	Self-Standing	Natural	Y	Y	Bag	20	5000
	FCT312120	2.0	Natural	Self-Standing	Red	Y	Y	Bag	20	5000
	FCT312320	2.0	Natural	Self-Standing	Blue	Y	Y	Bag	20	5000
	FCT312420	2.0	Natural	Self-Standing	Yellow	Y	Y	Bag	20	5000
	FCT312520	2.0	Natural	Self-Standing	Green	Y	Y	Bag	20	5000
	FCT312620	2.0	Natural	Self-Standing	Pink	Y	Y	Bag	20	5000
	FCT312720	2.0	Natural	Self-Standing	Brown	Y	Y	Bag	20	5000
	FCT312820	2.0	Natural	Self-Standing	White	Y	Y	Bag	20	5000
	FCT312920	2.0	Natural	Self-Standing	Black	Y	Y	Bag	20	5000
	FCT310020	2.0	Natural	Self-Standing	Natural	Y	N	Bag	500	5000
	FCT311220	2.0	Natural	Self-Standing	Natural	Y	Y	Bag	500	5000
	FCT510920	2.0	Brown	Self-Standing	Brown	Y	N	Bag	500	5000
	FCT513920	2.0	Brown	Self-Standing	Brown	Y	Y	Bag	500	5000
	FCT315020	2.0	Natural	Self-Standing	Natural	Y	Y	Vial and Lid Separated	250	5000
	FCT315520	2.0	Natural	Self-Standing	Green	Y	Y	Vial and Lid Separated	250	5000
	FCT315620	2.0	Natural	Self-Standing	Pink	Y	Y	Vial and Lid Separated	250	5000
	FCT315720	2.0	Natural	Self-Standing	Natural	Y	Y	Vial and Lid Separated	250	5000
	FCT315820	2.0	Natural	Self-Standing	White	Y	Y	Vial and Lid Separated	250	5000
	FCT010020	2.0	Natural	Conical	Natural	Y	N	Box	100	1000
	FCT011020	2.0	Natural	Conical	Natural	Y	Y	Box	100	1000
	FCT112020	2.0	Natural	Conical	Natural	Y	N	Bag	20	5000
	FCT122020	2.0	Natural	Conical	Natural	Y	Y	Bag	20	5000
	FCT412920	2.0	Brown	Conical	Brown	Y	N	Bag	20	5000
FCT422920	2.0	Brown	Conical	Brown	Y	Y	Bag	20	5000	
FCT210020	2.0	Natural	Conical	Natural	Y	N	Bag	500	5000	
FCT410920	2.0	Brown	Conical	Brown	Y	N	Bag	500	5000	
FCT411920	2.0	Brown	Conical	Brown	Y	Y	Bag	500	5000	

Cryogenic Vials(with tethered concave caps)

	Cat. No.	Capacity (mL)	Vial Color	Bottom	Lid Color	Graduation Line	Sterile	Package	Qty. Per Bag/Box	Qty. Per Case
	FCT561005	0.5	Natural	Self-Standing	Natural	N	Y	Bag	50	5000
	FCT561105	0.5	Natural	Self-Standing	Natural	Molded	Y	Bag	50	5000
	FCT571005	0.5	Natural	Conical	Natural	N	Y	Bag	50	5000
	FCT561015	1.5	Natural	Self-Standing	Natural	Molded	Y	Bag	50	5000
	FCT571015	1.5	Natural	Conical	Natural	Molded	Y	Bag	50	5000
	FCT561115	1.5	Natural	Self-Standing	Natural	N	Y	Bag	50	5000
	FCT561020	2.0	Natural	Self-Standing	Natural	Molded	Y	Bag	50	5000
	FCT561120	2.0	Natural	Self-Standing	Natural	N	Y	Bag	50	5000
	FCT571020	2.0	Natural	Conical	Natural	Molded	Y	Bag	50	5000
	FCT561220	2.0	Natural	Self-Standing	Natural	Silk Screened	Y	Bag	50	5000

Tethered Concave Caps with Different Color

	Cat No.	Lid Color	Sterile	Package	Qty. Per Bag	Qty. Per Case
	FCT441000	Natural	Y	Bag	500	5000
	FCT441100	Red	Y	Bag	500	5000
	FCT441200	Orange	Y	Bag	500	5000
	FCT441300	Blue	Y	Bag	500	5000
	FCT441400	Yellow	Y	Bag	500	5000
	FCT441500	Green	Y	Bag	500	5000
	FCT441600	Pink	Y	Bag	500	5000
	FCT441700	Brown	Y	Bag	500	5000
	FCT441800	White	Y	Bag	500	5000
	FCT441900	Black	Y	Bag	500	5000
	FCT440000	Natural	N	Bag	500	5000
	FCT440100	Red	N	Bag	500	5000
	FCT440200	Orange	N	Bag	500	5000
	FCT440300	Blue	N	Bag	500	5000
	FCT440400	Yellow	N	Bag	500	5000
	FCT440500	Green	N	Bag	500	5000
	FCT440600	Pink	N	Bag	500	5000
	FCT440700	Brown	N	Bag	500	5000
	FCT440800	White	N	Bag	500	5000
	FCT440900	Black	N	Bag	500	5000

Cryogenic Vial Inserts

	Cat No.	Color	Sterile	Qty. Per Bag/Box	Qty. Per Case
	FTC000001	Natural	N	500	5000
	FTC000002	White	N	500	5000
	FTC000003	Green	N	500	5000
	FTC000004	Blue	N	500	5000
	FTC200001	Natural	Y	500	5000
	FTC200002	White	Y	500	5000
	FTC200003	Green	Y	500	5000
	FTC200004	Blue	Y	500	5000
	FTC200005	Orange	Y	500	5000
	FTC200006	Red	Y	500	5000
	FTC200007	Brown	Y	500	5000
	FTC200008	Yellow	Y	500	5000



Stock code: 688026

Liquid Handling and Storage



Liquid handling is an essential process that matters to results in both scientific experiments and industrial production. JET BIOFIL offers an extensive range of products for liquid handling and storage, including centrifuge tubes, pipettes, and tips. All these products are manufactured in Class 100,000 cleanrooms using high-quality raw materials that conform to USP Class VI standards. Rich in variety and specifications, they are compatible with a wide spectrum of products available on the market such as centrifuges, pipettes, and automated liquid-handling workstations. Non-pyrogenic and DNase/RNase-free, they are of superior quality and boast stable performance. You can choose your preferred products according to the volume of liquid to be handled and your needs in various experiments.

Centrifuge Tubes

The 15 mL and 50 mL centrifuge tubes are made of USP Class VI standards polypropylene (PP) and are suitable for laboratory centrifugation in various fields such as cell biology, immunology, microbiology and molecular biology, as well as for sample preparation and sample storage.

- Specification: 15 mL 50 mL
- Cap Type: Flat Plug Seal
- Bottom Type: Conical Self-standing
- Packaging: Re-sealable Bag Paper Rack Plastic Rack Bulk
- Materials: Tube Body: Polypropylene (PP), Tube Cap: High-density polyethylene (HDPE), conforming to USP Class VI standards



Features

- Easy-to-read black graduations and an accuracy within $\pm 2\%$
- The centrifuge tubes feature black printed graduations and a large white writing area resistant to alcohol wiping
- Maximum RCF: 12,000 $\times g$ (Conical tube), RCF: 6,000 $\times g$ (Self-standing tube)
- Working temperature range: -80°C - -121°C
- Tube Body Marked with Maximum Liquid Volume Indicator during Freezing
- Leak-proof
- Sterilized and non-sterilized available, sterilized by irradiation to SAL 10^{-6}
- DNase/RNase-free, non-pyrogenic

- Warning: 1. Do not use foam racks for cryopreservation (-80°C - -20°C) of centrifuge tubes.
2. Loosen cap during autoclave sterilization

Centrifuge Tubes with Flat Cap

	Cat. No.	Capacity (mL)	Bottom	Sterile	Maximum RCF ($\times g$)	Package	Qty. Per Bag	Qty. Per Case
	CFT000150	15.0	Conical	N	12,000	Bulk	500	500
	CFT010150	15.0	Conical	N	12,000	Re-sealable bag	50	500
	CFT011150	15.0	Conical	Y	12,000	Re-sealable bag	25	500
	CFT021150	15.0	Conical	Y	12,000	Paper rack	25	500
	CFT031150	15.0	Conical	Y	12,000	Plastic Rack	25	300
	CFT000500	50.0	Conical	N	12,000	Bulk	500	500
	CFT010500	50.0	Conical	N	12,000	Re-sealable bag	50	500
	CFT011500	50.0	Conical	Y	12,000	Re-sealable bag	25	500
	CFT021500	50.0	Conical	Y	12,000	Paper rack	25	500
	CFT100500	50.0	Self-standing	N	6,000	Bulk	500	500
	CFT111500	50.0	Self-standing	Y	6,000	Re-sealable bag	25	500
	CFT110500	50.0	Self-standing	N	6,000	Re-sealable bag	50	500
	CFT031500	50.0	Conical	Y	12,000	Plastic Rack	25	300

Centrifuge Tubes with Plug Seal Cap

	Cat. No.	Capacity (mL)	Bottom	Cap Gasket	Sterile	Maximum RCF ($\times g$)	Package	Qty. Per Bag	Qty. Per Case
	CFT550150	15.0	Conical	N	N	12,000	Bulk	500	500
	CFT510150	15.0	Conical	N	N	12,000	Re-sealable bag	50	500
	CFT511150	15.0	Conical	N	Y	12,000	Re-sealable bag	25	500
	CFT521150	15.0	Conical	N	Y	12,000	Paper rack	25	500
	CFT621150	15.0	Conical	N	Y	12,000	Plastic Rack	25	300
	CFT522150	15.0	Conical	N	N	12,000	Paper rack	25	500
	CFT510500	50.0	Conical	N	N	12,000	Re-sealable bag	50	500
	CFT511500	50.0	Conical	N	Y	12,000	Re-sealable bag	25	500
	CFT521500	50.0	Conical	N	Y	12,000	Paper rack	25	500
	CFT621500	50.0	Conical	N	Y	12,000	Plastic Rack	25	300
	CFT660500	50.0	Self-standing	N	N	6,000	Bulk	500	500
	CFT610500	50.0	Self-standing	N	N	6,000	Re-sealable bag	50	500
	CFT611500	50.0	Self-standing	N	Y	6,000	Re-sealable bag	25	500
	CFT615500	50.0	Conical	Y	Y	12,000	Re-sealable bag	25	500
	CFT616500	50.0	Conical	Y	N	12,000	Paper rack	25	500
	CFT617500	50.0	Conical	Y	Y	12,000	Plastic Rack	25	500
	CFT656500	50.0	Conical	Y	N	12,000	Bulk	500	500
	CFT614500	50.0	Self-standing	Y	N	6,000	Bulk	500	500
	CFT613500	50.0	Self-standing	Y	Y	6,000	Re-sealable bag	25	500

Conical Centrifuge Bottles

The conical centrifuge bottles are economical laboratory consumables for large-capacity liquid centrifugation and are suitable for large-scale cell harvesting, as well as plasmid and protein purification. These products can help researchers reduce centrifugation cycles and increase efficiency in experiments and production.

- Specification: 225 mL 250 mL 500 mL 600 mL
- Materials: Tube Body: Polypropylene (PP), Tube Cap: High-density polyethylene (HDPE), conforming to USP Class VI standards
- Bottom Type: Conical



Features

- The bottle body is made of high-quality PP, which is resistant to high temperatures and high pressure, and has smooth inner and outer surfaces and a uniform gloss.
- Clear graduation lines facilitate easy observation, accuracy within $\pm 2\%$
- 225 mL/250 mL maximum RCF: 7,500 $\times g$, 500 mL/600 mL maximum RCF: 6,000 $\times g$
- Screw seal cap design applied, 100% undergone for production line sealing performance tests to ensure zero leakage
- Recommended liquid feeding volume: 80% of max graduated volume
- Working temperature range: -80°C-121°C
- Sterilized by irradiation, SAL 10⁻⁶
- DNase/RNase-free, non-pyrogenic

Cat. No.	Capacity (mL)	Bottom	Sterile	Maximum RCF ($\times g$)	Package	Qty. Per Bag	Qty. Per Case
CFT012225	225.0	Conical	Y	7500	Re-sealable bag	6	48
CFT012250	250.0	Conical	Y	7500	Re-sealable bag	6	48
CFT013500	500.0	Conical	Y	6000	Re-sealable bag	6	36
CFT041500	500.0	Conical	Y	6000	Re-sealable bag	6	36
CFT020600	600.0	Conical	Y	6000	Individually Packed	1	32

High-Performance Centrifuge Tubes

The high-performance centrifuge tubes are widely used in various experimental procedures, meeting the requirements of biological experiments. They comply with the ROHS standards, TSE/BSE risk statements, and do not contain latex components. The tubes are designed with a unique dual-color cap for better sealing. The tube body can withstand up to a 90Kpa negative pressure and a 20,000 $\times g$ centrifugal force.



- Specification: 15 mL 50 mL
- Cap Type: Dual Cap (with Gasket)
- Bottom Type: Conical Self-standing
- Materials: Tube Body: Polypropylene (PP), Tube Cap: High-density polyethylene (HDPE), Cap Gasket: Thermoplastic Elastomer (TPE), conforming to USP Class VI standards
- Packaging: Re-sealable Bag Paper Rack Plastic Rack

Cat. No.	Capacity (mL)	Bottom	Sterile	Maximum RCF ($\times g$)	Package	Qty. Per Bag (Rack)	Qty. Per Case
CFT920150	15.0	Conical	Y	20,000	Paper rack	50	500
CFT921150	15.0	Conical	Y	20,000	Re-sealable bag	25	500
CFT922150	15.0	Conical	Y	20,000	Re-sealable bag	50	500
CFT925150	15.0	Conical	N	20,000	Re-sealable bag	50	500
CFT926150	15.0	Conical	Y	20,000	Plastic Rack	25	300
CFT920500	50.0	Conical	Y	20,000	Paper rack	25	500
CFT921500	50.0	Conical	Y	20,000	Re-sealable bag	25	500
CFT922500	50.0	Conical	Y	20,000	Re-sealable bag	50	500
CFT925500	50.0	Conical	N	20,000	Re-sealable bag	50	500
CFT928500	50.0	Conical	Y	20,000	Plastic Rack	25	300
CFT926500	50.0	Self-standing	Y	10,000	Re-sealable bag	50	500
CFT927500	50.0	Self-standing	N	10,000	Re-sealable bag	50	500

Light Sensitive Centrifuge Tubes

The 15 mL and 50 mL light sensitive centrifuge tubes are made of polypropylene (PP) conforming to USP Class VI standards and can block 100% of UV rays. They are designed for light-proof storage or centrifugation of light-sensitive samples.



- Specification: 15 mL 50 mL
- Cap Type: Plug seal
- Bottom Type: Conical
- Materials: Tube Body: Polypropylene (PP), Tube Cap: High-density polyethylene (HDPE), conforming to USP Class VI standards
- Packaging: Re-sealable Bag Paper Rack

Cat. No.	Capacity (mL)	Bottom	Sterile	Maximum RCF (×g)	Package	Qty. Per Bag	Qty. Per Case
CFT710150	15.0	Conical	N	12,500	Re-sealable bag	50	500
CFT711150	15.0	Conical	Y	12,500	Re-sealable bag	25	500
CFT712150	15.0	Conical	Y	12,500	Paper rack	25	500
CFT710500	50.0	Conical	N	12,500	Re-sealable bag	50	500
CFT711500	50.0	Conical	Y	12,500	Re-sealable bag	25	500
CFT712500	50.0	Conical	Y	12,500	Paper rack	25	500

High-RCF Centrifuge Tubes

The high-RCF centrifuge tubes are made of transparent polymer polypropylene (PP) material to withstand a centrifugal force of up to 21,000×g. The products can be widely used in a variety of experimental operations to meet the requirements of biological experiments while preventing rupture and leakage during high-speed centrifugation.



- Specification: 15 mL 50 mL
- Cap Type: Flat
- Bottom Type: Conical
- Packaging: Re-sealable Bag Paper Rack
- Materials: Tube Body: Polypropylene (PP), Tube Cap: High-density polyethylene (HDPE), conforming to USP Class VI standards



Easy-to-read black graduations and an accuracy within ±2%

Features a large white writing area convenient for marking and recording, and resistant to alcohol wiping

- ⚠ Warning: 1. Do not use foam racks for cryopreservation (-80°C--20°C) of centrifuge tubes.
2. Loosen cap during autoclave sterilization.

Cat. No.	Capacity (mL)	Bottom	Sterile	Maximum RCF (×g)	Package	Qty. Per Bag	Qty. Per Case
CFT312150	15.0	Conical	Y	21,000	Re-sealable bag	25	500
CFT322150	15.0	Conical	Y	21,000	Paper rack	25	500
CFT312500	50.0	Conical	Y	21,000	Re-sealable bag	25	500
CFT322500	50.0	Conical	Y	21,000	Paper rack	25	500

15 ml Centrifuge Tube with Puncture Hole

This product is made of high-quality transparent polymer polypropylene (PP); the cap features a butyl rubber stopper for connecting to a syringe.

- Specification: 15 mL
- Bottom Type: Conical
- Materials: Tube body: Polypropylene (PP), Tube cover: High-density polyethylene (HDPE), conforming to USP Class VI standards



The cap features a BD hole

Cat. No.	Volume (mL)	Bottom	Sterile	Max Rotational Speed (×g)	Description	Package	Qty. Per Bag	Qty. Per Case
CFT013150-BD	15.0	Conical	Y	12500	Light green cap with a butyl rubber stopper, pierceable for syringe connection, sterilized	Re-sealable bag	Cap: 100 Tube: 25	Cap: 500 Tube: 500

Metal-Free Centrifuge Tubes

The metal-free centrifuge tubes are made of transparent polypropylene (PP). They have been specially treated to ensure that more than 30 kinds of trace metal elements that can interfere with experiments are kept at levels of less than 1ppb (ICP-MS method). They are ideal for a variety of environmental tests such as water analysis, and other applications where samples may be contaminated by heavy metals in centrifuge tubes.



- Specification: 15 mL 50 mL
- Cap Type: Flat
- Bottom Type: Conical
- Packaging: Re-sealable Bag Paper Rack Bulk
- Materials: Tube Body: Polypropylene (PP), Tube Cap: High-density polyethylene (HDPE), conforming to USP Class VI standards

Cat. No.	Capacity (mL)	Bottom	Sterile	Maximum RCF (×g)	Package	Qty. Per Bag(Rack, Bulk)	Qty. Per Case
CFT450150	15.0	Conical	Y	12,500	Re-sealable bag	25	500
CFT451150	15.0	Conical	Y	12,500	Paper rack	50	500
CFT452150	15.0	Conical	Y	12,500	Bulk	500	500
CFT450500	50.0	Conical	Y	12,500	Re-sealable bag	25	500
CFT451500	50.0	Conical	Y	12,500	Paper rack	25	500
CFT452500	50.0	Conical	Y	12,500	Bulk	500	500

EasyFlip™ Centrifuge Tubes

These products are primarily used for the storage, operation and centrifugation of mid-volume samples. The caps are easy to flip open and can be operated with one hand.

- Specification: 15 mL 50 mL
- Bottom Type: Conical bottom
- Packaging: Re-sealable Bag Paper Rack
- Materials: Tube Body: Polypropylene (PP), Tube Cap: High-density polyethylene (HDPE), conforming to USP Class VI standards



Cat. No.	Capacity (mL)	Bottom	Sterile	Maximum RCF (xg)	Package	Qty. Per Bag(Rack, Bulk)	Qty. Per Case
CFT201150	15.0	Conical	N	9,400	Bulk	500	500
CFT211150	15.0	Conical	Y	9,400	Re-sealable bag	25	500
CFT221150	15.0	Conical	Y	9,400	Paper rack	50	500
CFT212150	15.0	Conical	Y	9,400	Re-sealable bag	25	500
CFT222150	15.0	Conical	Y	9,400	Paper rack	50	500
CFT201500	50.0	Conical	N	9,400	Bulk	500	500
CFT211500	50.0	Conical	Y	9,400	Re-sealable bag	25	500
CFT221500	50.0	Conical	Y	9,400	Paper rack	50	500
CFT212500	50.0	Conical	Y	9,400	Re-sealable bag	25	500
CFT222500	50.0	Conical	Y	9,400	Paper rack	25	500

30 mL Self-Standing Centrifuge Tubes

The 30 mL self-standing centrifuge tubes are suitable for storage, operation and centrifugation of mid-volume samples. The products have the same diameter as the 50 mL centrifuge tube, but with a lower height. This reduces the risk of sample contamination and fills the gap between traditional 15 mL and 50 mL centrifuge tubes.

- Specification: 30 mL
- Cap Type: Flat
- Bottom Type: Self-standing
- Packaging: Re-sealable Bag
- Materials: Tube Body: Polypropylene (PP), Tube Cap: High-density polyethylene (HDPE), conforming to USP Class VI standards

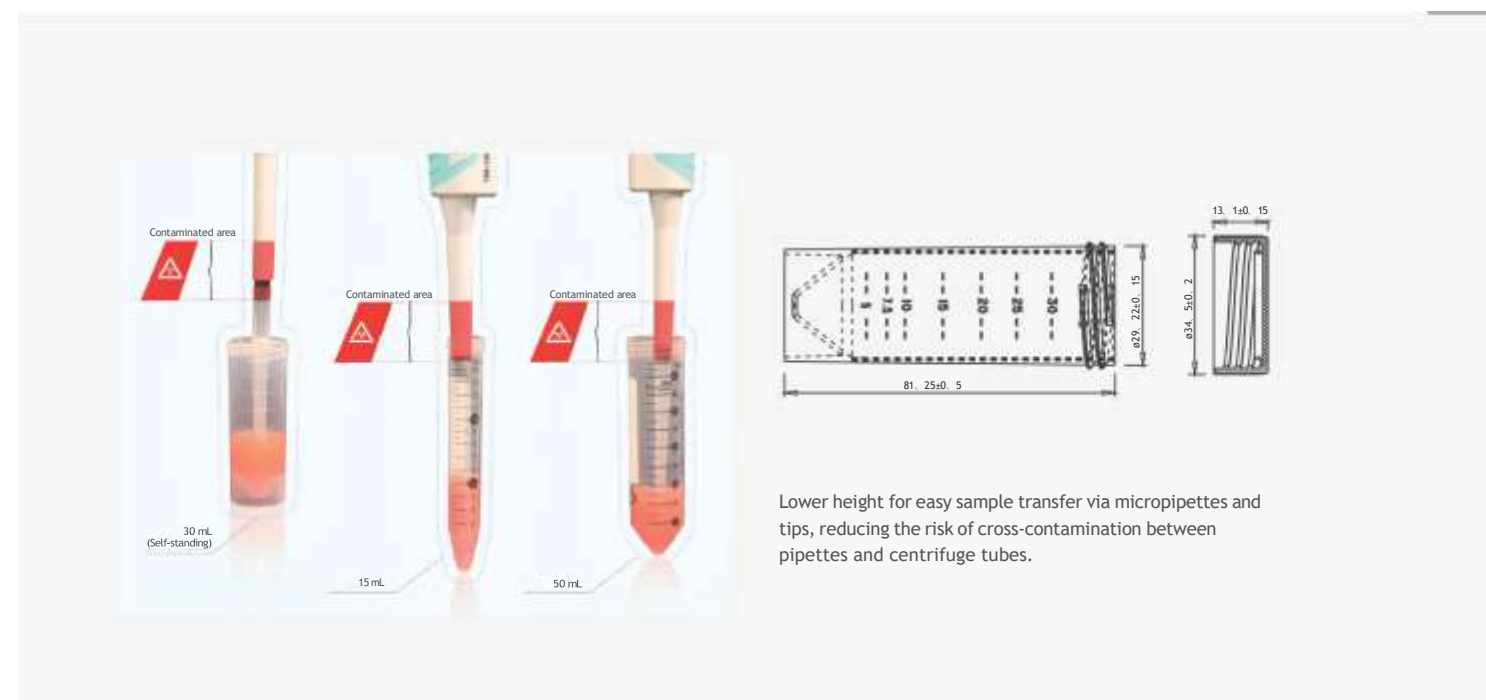

Cat. No.	Capacity (mL)	Bottom	Sterile	Maximum RCF (xg)	Package	Qty. Per Bag	Qty. Per Case
CFT001030	30.0	Self-standing	Y	7,500	Re-sealable bag	50	500
CFT011030	30.0	Self-standing	N	7,500	Re-sealable bag	50	500
CFT000030	30.0	Self-standing	N	7,500	Re-sealable bag	500	500

PBMC Separation Tubes

The JET BIOFIL PBMC Separation Tubes boast a unique design featuring a built-in separation bracket, which effectively reduces the mixing of target samples and the density gradient medium during the centrifugation process. This design allows Mononuclear Cells (MNCs) to be retained above the separation bracket, separating them from the red blood cells and granulocyte layer present at the tube's bottom. MNCs can be effortlessly collected without the need for complex steps, streamlining experiments and saving time compared to traditional methods.

PBMC Separation Tubes strictly adhere to the Good Manufacturing Practice (GMP) standards. It meets the requirements for biological laboratory consumables with a higher cleanliness grade, ensuring its suitability for various experimental applications.

- Specification: 15 mL / 50 mL with separation bracket
- Bottom Type: Conical
- Material: Tube Body: Polypropylene (PP), Tube Cap: High-density polyethylene (HDPE), Separation Bracket: Methyl methacrylate-butadiene-styrene (MBS), conforming to USP Class VI standards.
- Cap Type: Flat
- Separation Bracket Type: Eight-hole Cylindrical



Features

- The built-in separation bracket minimizes the mixing of the sample and the separation medium, thereby avoiding the need for slow and laborious application of the sample to the upper layer of the density gradient medium
- Easy to operate, with MNCs collected by directly pouring out after centrifugation
- High consistency minimizes the influence of human operation on experimental outcomes
- Rapidly isolates peripheral blood mononuclear cells (PBMCs) within a 15-minute time frame
- The PBMC Separation Tubes are manufactured in strict adherence to GMP standards, and the finished items undergo rigorous third-party testing to meet the experimental requirements for consumables with a higher cleanliness grade
- Triple independent bagged clean medical outer packaging, with product lot number marked on the innermost layer for traceability
- Sterilized by irradiation, SAL 10⁻⁶
- DNase/RNase-free, non-pyrogenic, non-cytotoxic and no mycoplasma

Cat. No.	Description	Sterile	Undiluted Volume	Qty. Per Bag	Qty. Per Case
CSP021015	Tube with separation scaffold (15 mL/tube)	Y	0.5-4mL	25	100
CSP021050	Tube with separation scaffold (50 mL/tube)	Y	4-17mL	25	100

Plastic Centrifuge Tube Racks

Jet Biofil's centrifuge tube racks are made of high-quality polypropylene (PP) material, designed to securely hold centrifuge tubes upright, preventing spills or sample displacement. We offer various specifications to accommodate microcentrifuge tubes, standard centrifuge tubes, and large-capacity centrifuge bottles, ensuring convenient sample handling and storage.

- Applicable Volumes: 0.2 mL 0.5 mL 1.5 mL 2.0 mL 5.0 mL 15 mL 50 mL 225 mL 250 mL 600 mL
- Color: Light Green Green White Blue
- Materials: Polypropylene (PP), conforming to USP Class VI standards

Features

- Suitable for 15 mL and 50 mL centrifuge tubes; surface with markings easy to identify and convenient for experimental recording
- Stackable to save space
- Working temperature range: from -80°C to 121°C
- Can be cleaned for re-use
- Sterilized and non-sterilized available, sterilized by irradiation to SAL 10⁻⁶
- DNase/RNase-free, non-pyrogenic

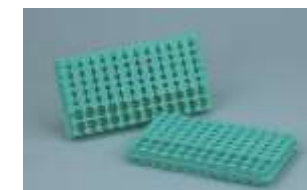
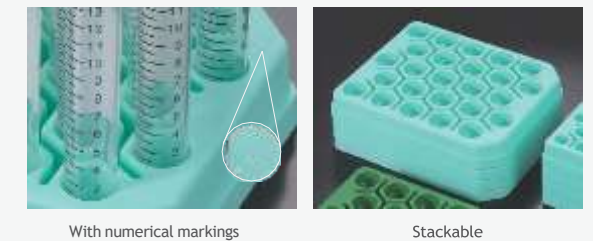

Micro Centrifuge Tube Rack

Cat. No.	Applicable Volume (mL)	Holes	Sterile	Color	Stackable	Qty. Per Bag	Qty. Per Case
CTS003001	0.2	30	N	Light green	Y	1	20
	0.5	60	N	Light green	Y	1	20
	1.5, 2.0	72	N	Light green	Y	1	20
	5.0	24	N	Light green	Y	1	20



Centrifuge Tube Racks

Cat. No.	Applicable Volume (mL)	Holes	Sterile	Color	Stackable	Qty. Per Bag	Qty. Per Case
CFR001015	15	25	N	Light green	Y	5	50
CFR011015	15	25	Y	Light green	Y	5	50
CFR002015	15	25	N	Dark green	Y	5	50
CFR012015	15	25	Y	Dark green	Y	5	50
CFR003015	15	25	N	White	Y	5	50
CFR013015	15	25	Y	White	Y	5	50
CFR004015	15	25	N	Blue	Y	5	50
CFR014015	15	25	Y	Blue	Y	5	50



Centrifuge Tube Racks

Cat. No.	Applicable Volume (mL)	Holes	Sterile	Color	Stackable	Qty. Per Bag	Qty. Per Case
CFR001050	50	25	N	Light green	Y	5	50
CFR011050	50	25	Y	Light green	Y	5	50
CFR002050	50	25	N	Dark green	Y	5	50
CFR012050	50	25	Y	Dark green	Y	5	50
CFR003050	50	25	N	White	Y	5	50
CFR013050	50	25	Y	White	Y	5	50
CFR004050	50	25	N	Blue	Y	5	50
CFR014050	50	25	Y	Blue	Y	5	50

Centrifuge Tube Stands

Cat. No.	Applicable Volume (mL)	Holes	Sterile	Color	Stackable	Qty. Per Bag	Qty. Per Case
CTS001001		7	N	Light green	N	1	50
CTS002001	7 holes, suitable for 2.0 mL microcentrifuge tube and 15 mL, 50 mL centrifuge tubes	7	Y	Light green	N	1	50
CTS001002		7	N	Light green	N	5	50
CTS002002		7	Y	Light green	N	5	50

Conical Centrifuge Bottle Racks

Cat. No.	Applicable Volume (mL)	Holes	Sterile	Color	Stackable	Qty. Per Bag	Qty. Per Case
CTS001225	225, 250	6	N	Light green	Y	6	12
CTS001500	500	4	N	Light green	Y	6	12
CTS001600	600	3	N	Light green	Y	6	12

Serum & Sample Tubes

The serum & sample tubes are made of transparent polypropylene (PP), and have excellent chemical stability and air tightness, making them suitable for the preservation and cryopreservation of serum, cells and tissues.

- ◎ Specification: 0.5 mL 1.5 mL 2.0 mL 5.0 mL 15.0 mL 50.0 mL
- ◎ Materials: Tube Body: Polypropylene (PP), Tube Cap: High-density polyethylene (HDPE), conforming to USP Class VI standards
- ◎ Bottom Type: Conical Self-standing

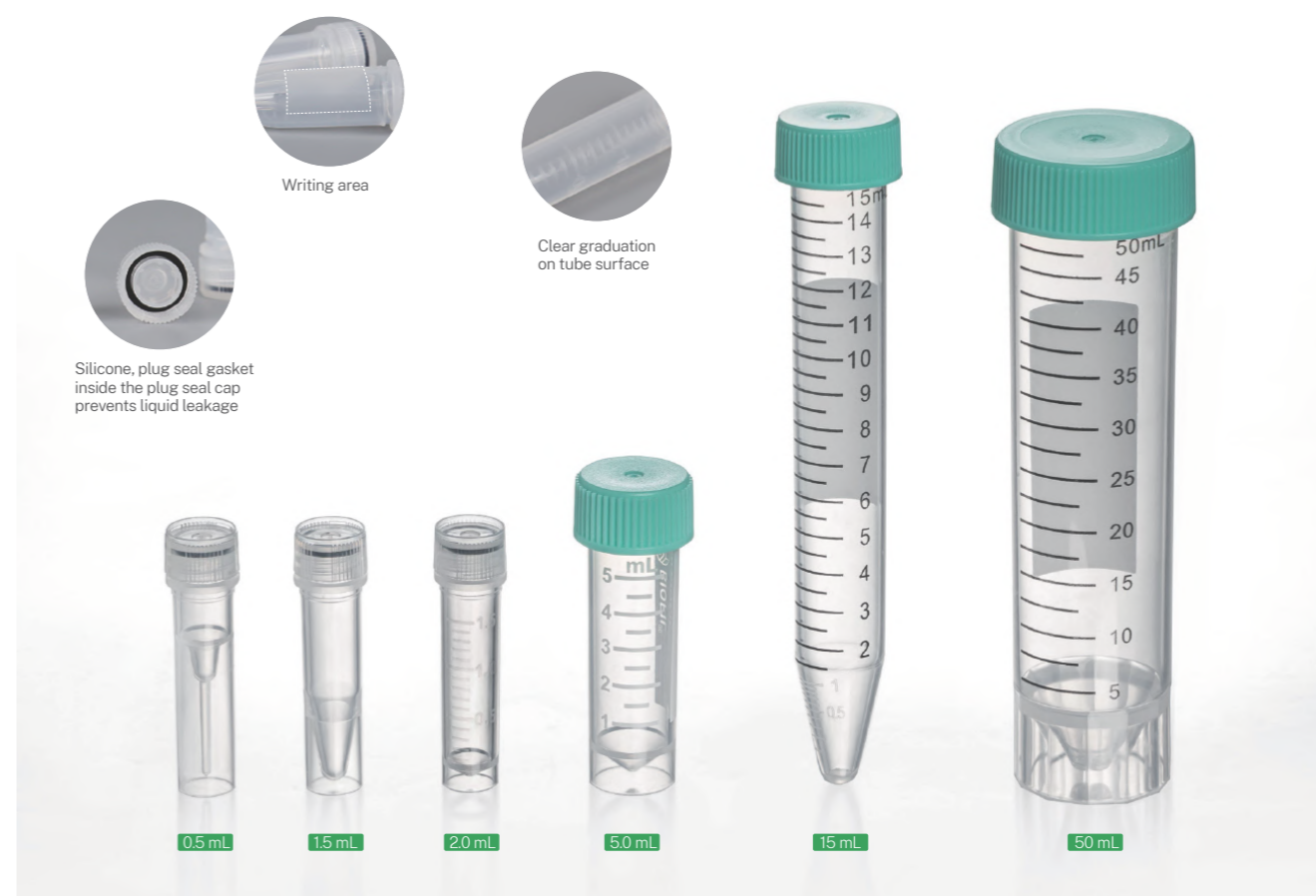

Features

- ◎ 6 specifications available: 0.5 mL, 1.5 mL, 2.0 mL, 5.0 mL, 15.0 mL, 50.0 mL
- ◎ The tube is made of PP—even transparent, and resistant to ultra-low temperature.
- ◎ The tube body is designed with writing area to facilitate recognition and labeling
- ◎ Silicone plug seal washer inside the plug seal cap prevents liquid leakage
- ◎ Sterilized and non-sterilized versions are available. Sterilized by irradiation, SAL 10⁻⁶
- ◎ DNase/RNase-free, non-pyrogenic

Cat. No.	Capacity (mL)	Bottom	Graduation Line	Sterile	Qty. Per Bag	Qty. Per Case
SST000005	0.5	Self-standing	Without	N	50	5000
SST001005	0.5	Self-standing	Without	Y	50	5000
SST001015	1.5	Self-standing	Without	Y	50	5000
SST000015	1.5	Self-standing	Without	N	50	5000
SST001020	2.0	Self-standing	With	Y	20	5000
SST000020	2.0	Self-standing	With	N	20	5000
SST001050	5.0	Self-standing	With	Y	20	2500
SST000050	5.0	Self-standing	With	N	20	2500
SST001150	15.0	Conical	With	Y	25	500
SST000150	15.0	Conical	With	N	50	500
SST001500	50.0	Self-standing	With	Y	25	500
SST000500	50.0	Self-standing	With	N	25	500

Plastic Pasteur Pipets

Plastic pasteur pipets are suitable for quick pipetting or transfer of liquids of non-fixed amounts.

- ◎ Specification: 145 mm 230 mm
- ◎ Packaging: Individual package (paper/plastic) Bulk
- ◎ Materials: Polystyrene (PS), conforming to USP Class VI standards



Features

- ◎ Two specifications are available: 145 mm and 230 mm
- ◎ Slender tube tip makes it easy to remove liquids from narrow-mouthed or small containers
- ◎ Transparent and scale-free for easy observation
- ◎ Sterilized by irradiation, SAL 10⁻⁶
- ◎ DNase/RNase-free, non-pyrogenic

Cat. No.	Length (mm)	Material	Sterile	Package	Qty. Per Bag(Bulk)	Qty. Per Case
PP000145	145.0	PS	Y	Individual	50	200
PP010145	145.0	PS	Y	Bulk	25	200
PP000230	230.0	PS	Y	Individual	50	200
PP010230	230.0	PS	Y	Bulk	25	200

Serological Pipets

Serological pipets are mainly used to measure or transfer a certain volume of liquid. When used with a suitable pipette, they have wide applications in the fields of cell culture, bacteriology, as well as clinical and scientific research. The JET BIOFIL serological pipets, in addition to having a pipet body with different precision graduations, feature pipet heads that are marked with the different capacities and different color codes for the ease of identification and use. The head of the pipet features a filter plug that prevents cross-contamination when aspirating samples, and the products are compatible with various common pipettes thanks to its optimized pipet head design.

- ◎ Specification: 1.0 mL 2.0 mL 5.0 mL 10.0 mL 25.0 mL 50.0 mL 100.0 mL
- ◎ Packaging: Individual Package (Paper/Plastic) Individual Package (Plastic/Plastic) Individual Package in Bag (Paper/Plastic) Individual Package in Bag (Plastic/Plastic) Bulk
- ◎ Materials: Pipet Body: Polystyrene (PS), Pipet Filter: Polyolefin (PO), conforming to USP Class VI standards

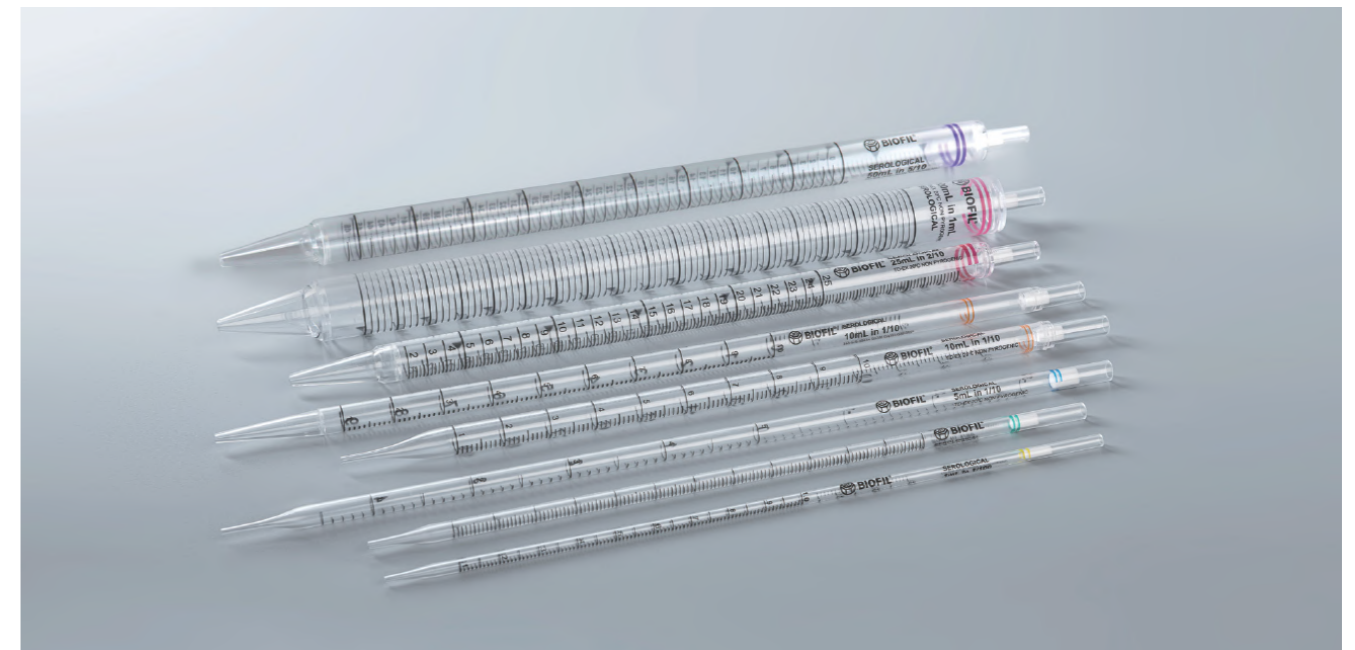

The pipet head is marked with different color codes, making the pipet range and model easy to identify



Designed with dual graduation markings, ensuring the pipet volume can be easily identified



Choice of ultrasonic welding or stretching



The filter element, made of PO, prevents aerosols or liquids from contaminating the pipetting device

Features

- Various capacities and specifications are available
- The pipet head is marked with different color codes for easy identification of the pipet range and model
- Designed with dual graduation to facilitate the identification of pipetting volumes. Negative graduations enhance pipet capacity and satisfy larger volume requirements
- The graduation is clear and precise, and has an accuracy of up to $\pm 2\%$ of the total volume
- Pipets of each specification are equipped with a filter element, which can prevent the sample, as well as any aerosol or water vapor, from entering the pipette; it also prevents impurities in the pipette from contaminating the sample, as well as cross-contamination
- The 1.0, 2.0, 5.0 and 10.0 mL pipets are stretched, while the 10.0, 25.0, 50.0 and 100 mL pipets are ultrasonically welded at the tip and mouth
- The optimized pipet head is compatible with most kinds of pipette with an adapter tip that are available on the market.
- A variety of packaging methods are available: paper-plastic or plastic-plastic, which can be torn or opened for easy operation; the bulk package is easy to use in batches and reduces packaging waste
- Assembled by ultrasonic welding, 100% undergone rigorous production line air-tightness testing
- Individually blister packed in peel-to-open paper/plastic and plastic/plastic wrappers with printed lot No. for quality traceability
- Sterilized and non-sterilized available, sterilized by irradiation to SAL 10^{-6}
- DNase/RNase-free, non-pyrogenic

Bulk Vacuum Package

Cat. No.	Volume (mL)	Graduation (mL)	Length (mm)	Color Code	Sterile	Qty. Per Bulk	Qty. Per Case
GSP012001	1.0	1/100	268.5	Yellow	Y	25	1000
GSP012002	2.0	1/50	272.0	Green	Y	25	1000
GSP012005	5.0	1/10	341.0	Blue	Y	25	500
GSP012010	10.0	1/10	346.3	Orange	Y	25	400
GSP012110	10.0, Wide Mouth	1/10	346.3	Orange	Y	25	400
GSP112010	10.0, Stretch	1/10	303.4	Orange	Y	25	400
GSP121010	10.0, Stretch	1/10	303.4	Orange	Y	50	200
GSP012025	25.0	2/10	308.5	Red	Y	10	150
GSP012125	25.0, Long	2/10	338.9	Red	Y	10	150
GSP012050	50.0	5/10	346.6	Dark Blue	Y	10	100
GSP012100	100.0	1	346.8	Pink	Y	10	60
GSP011001	1.0	1/100	268.5	Yellow	N	25	1000
GSP011002	2.0	1/50	272.0	Green	N	25	1000
GSP011102	2.0	1/100	272.0	Green	N	25	1000
GSP011005	5.0	1/10	341.0	Blue	N	25	500
GSP011010	10.0	1/10	346.3	Orange	N	25	400
GSP011110	10.0, Wide Mouth	1/10	346.3	Orange	N	25	400
GSP0111010	10.0, Stretch	1/10	303.4	Orange	N	25	400
GSP011025	25.0	2/10	308.5	Red	N	10	150
GSP011125	25.0, Long	2/10	338.9	Red	N	10	150
GSP011050	50.0	5/10	346.6	Dark Blue	N	10	100
GSP011100	100.0	1	346.8	Pink	N	10	60

Serological Pipets, Individually Packaged (Paper/Plastic)

Cat. No.	Volume (mL)	Graduation (mL)	Length (mm)	Color Code	Sterile	Qty. Per Bag	Qty. Per Case
GSP010001	1.0	1/100	268.5	Yellow	Y	1	500
GSP010002	2.0	1/50	272.0	Green	Y	1	500
GSP010102	2.0	1/100	272.0	Green	Y	1	500
GSP010005	5.0	1/10	341.0	Blue	Y	1	200
GSP010010	10.0	1/10	346.3	Orange	Y	1	200
GSP010110	10.0, Wide Mouth	1/10	346.3	Orange	Y	1	200
GSP211010	10.0, Stretch	1/10	303.4	Orange	Y	1	200
GSP010025	25.0	2/10	308.5	Red	Y	1	150
GSP010125	25.0, Long	2/10	338.9	Red	Y	1	150
GSP010050	50.0	5/10	346.6	Dark Blue	Y	1	100
GSP010100	100.0	1	346.8	Pink	Y	1	50

Serological Pipets, Individually Vacuum-packed in Bag (Paper/Plastic with internal sleeves)

Cat. No.	Volume (mL)	Graduation (mL)	Length (mm)	Color Code	Sterile	Qty. Per Bag	Qty. Per Case
GSP110001	1.0	1/100	268.5	Yellow	Y	100	600
GSP110002	2.0	1/50	272.0	Green	Y	100	500
GSP110102	2.0	1/100	272.0	Green	Y	100	500
GSP110005	5.0	1/10	341.0	Blue	Y	50	200
GSP110010	10.0	1/10	346.3	Orange	Y	50	200
GSP110110	10.0, Wide Mouth	1/10	346.3	Orange	Y	50	200
GSP210010	10.0, Stretch	1/10	303.4	Orange	Y	50	200
GSP110025	25.0	2/10	308.5	Red	Y	50	150
GSP110125	25.0, Long	2/10	338.9	Red	Y	50	150
GSP110050	50.0	5/10	346.6	Dark Blue	Y	30	90
GSP110100	100.0	1	346.8	Pink	Y	10	50

Serological Pipets, Individually Packaged (Plastic/Plastic with internal sleeves)

Cat. No.	Volume (mL)	Graduation (mL)	Length (mm)	Color Code	Sterile	Qty. Per Bag	Qty. Per Case
GSP020001	1.0	1/100	268.5	Yellow	Y	1	500
GSP020002	2.0	1/50	272.0	Green	Y	1	500
GSP020102	2.0	1/100	272.0	Green	Y	1	500
GSP020005	5.0	1/10	341.0	Blue	Y	1	200
GSP010105	5.0, Wide Mouth	1/10	341.0	Blue	Y	1	200
GSP020010	10.0	1/10	346.3	Orange	Y	1	200
GSP020110	10.0, Wide Mouth	1/10	346.3	Orange	Y	1	200
GSP021010	10.0, Stretch	1/10	303.4	Orange	Y	1	200
GSP020025	25.0	2/10	308.5	Red	Y	1	150
GSP020125	25.0, Long	2/10	338.9	Red	Y	1	150
GSP020050	50.0	5/10	346.6	Dark Blue	Y	1	100
GSP020100	100.0	1	346.8	Pink	Y	1	50

Serological Pipets, Individually Vacuum-packed in Bag (Plastic/Plastic with internal sleeves)

Cat. No.	Volume (mL)	Graduation (mL)	Length (mm)	Color Code	Sterile	Qty. Per Bag	Qty. Per Case
GSP120001	1.0	1/100	268.5	Yellow	Y	100	600
GSP120002	2.0	1/50	272.0	Green	Y	100	500
GSP120102	2.0	1/100	272.0	Green	Y	100	500
GSP120005	5.0	1/10	341.0	Blue	Y	50	200
GSP120010	10.0	1/10	346.3	Orange	Y	50	200
GSP120110	10.0, Wide Mouth	1/10	303.4	Orange	Y	50	200
GSP120025	25.0	2/10	308.5	Red	Y	50	150
GSP120125	25.0, Long	2/10	338.9	Red	Y	50	150
GSP120050	50.0	5/10	346.6	Dark Blue	Y	30	90
GSP120100	100.0	1	346.8	Pink	Y	10	50

Open End Pipets

The open end pipets are suitable for rapid suction of a certain volume of liquid during experiments, and are also able to suck up larger tissue blocks. They are widely used in the fields of tissue culture, and clinical and scientific research.

- Specifications: 1.0 mL 2.0 mL 5.0 mL 10.0 mL
- Packaging: Individual Package (Paper/Plastic) Individual Package in Bag (Plastic/Plastic) Bulk
- Materials: Pipet Body: Polystyrene (PS), Pipet Filter: Polyolefin (PO), conforming to USP Class VI standards



Serological Pipets Bulk Vacuum Package

Cat. No.	Volume (mL)	Graduation (mL)	Length (mm)	Color Code	Material	Sterile	Package	Qty. Per Bag	Qty. Per Case
GSP312005	5	1/10	319.0	■	PS	Y	Paper/Plastic	25	500
GSP312010	10	1/10	308.5	■	PS	Y	Paper/Plastic	25	500

Serological Pipets, Individually Packaged (Paper/Plastic)

Cat. No.	Volume (mL)	Graduation (mL)	Length (mm)	Color Code	Material	Sterile	Package	Qty. Per Bag	Qty. Per Case
GSP310001	1	1/10	270.0	■	PS	Y	Paper/Plastic	500	500
GSP310002	2	0.01	270.0	■	PS	Y	Paper/Plastic	500	500
GSP310005	5	1/10	319.0	■	PS	Y	Paper/Plastic	500	500
GSP310010	10	1/10	308.5	■	PS	Y	Paper/Plastic	200	200

Serological Pipets, Individually Vacuum-packed in Bag (Paper/Plastic)

Cat. No.	Volume (mL)	Graduation (mL)	Length (mm)	Color Code	Material	Sterile	Package	Qty. Per Bag	Qty. Per Case
GSP311005	5	1/10	319.0	■	PS	Y	Paper/Plastic	50	200
GSP311010	10	1/10	308.5	■	PS	Y	Paper/Plastic	50	200

Mini™ Serological Pipets

The Mini™ serological pipets are about half the length of a standard pipet, and is ergonomically designed for greater convenience when measuring and transferring liquids. They are especially suitable for liquid handling operations in limited and narrow spaces, such as laminar flow hoods.



- Specifications: 5.0 mL 10.0 mL 25.0 mL
- Packaging: Individual Package (Paper/Plastic)
- Materials: Pipet Body: Polystyrene (PS), Pipet Filter: Polyolefin (PO), conforming to USP Class VI standards

Cat. No.	Capacity (mL)	Graduation (mL)	Length (mm)	Color Code	Sterile	Package	Qty. Per Pack	Qty. Per Case
GSP010205	5	1/10	234	■	Y	Paper/Plastic	1	200
GSP010210	10	2/10	234	■	Y	Paper/Plastic	1	150
GSP010225	25	5/10	234	■	Y	Paper/Plastic	1	100

Aspirating Pipets

The aspirating pipets are transparent and graduation-free, to facilitate observation during liquid suction. The filter-free design satisfies customer demands for continuous extraction of waste liquid.

- Specifications: 1.0 mL 2.0 mL 5.0 mL 10.0 mL 25.0 mL 50.0 mL 100.0 mL
- Packaging: Individual Package (Paper/Plastic) Individual Package (Plastic/Plastic) Bulk
- Materials: Polystyrene (PS), conforming to USP Class VI standards



Aspirating Pipets, Bulk Package

Cat. No.	Volume (mL)	Length (mm)	Sterile	Qty. Per Bag	Qty. Per Case
GSP000001	1.0	268.5	Y	25	1000
GSP000002	2.0	270.0	Y	25	1000
GSP000005	5.0	341.0	Y	25	400
GSP000010	10.0	346.3	Y	25	400
GSP000025	25.0	308.5	Y	10	150
GSP000050	50.0	346.6	Y	10	100
GSP000100	100.0	346.8	Y	10	60
GSP001001	1.0	268.5	N	25	1000
GSP001002	2.0	270.0	N	25	1000
GSP001005	5.0	341.0	N	25	400
GSP001010	10.0	346.3	N	25	400
GSP001025	25.0	308.5	N	10	150
GSP001050	50.0	346.6	N	10	100
GSP001100	100.0	346.8	N	10	60

Aspirating Pipets, Individually Packaged (Plastic/Plastic), Stretch

Cat. No.	Volume (mL)	Length (mm)	Sterile	Qty. Per Bag	Qty. Per Case
GSP002010	10.0	303.4	Y	25	400
GSP003010	10.0	303.4	N	25	400
GSP101010	10.0	303.4	Y	200	200
GSP201010	10.0	303.4	Y	50	200

Milk Pipets

Suitable for the aspiration and transfer of micro-quantity liquids.

- Specification: 1.1 mL 2.2 mL
- Packaging: Individual Package (Paper/Plastic) Bulk
- Materials: Polystyrene (PS), conforming to USP Class VI standards



Aspirating Pipets, Individually Packaged (Paper/Plastic)

Cat. No.	Volume (mL)	Length (mm)	Sterile	Qty. Per Bag	Qty. Per Case
GSP100001	1.0	268.5	Y	1	500
GSP100002	2.0	270.0	Y	1	500
GSP100005	5.0	341.0	Y	1	200
GSP100010	10.0	346.3	Y	1	200
GSP100025	25.0	308.5	Y	1	150
GSP100050	50.0	346.6	Y	1	100
GSP100100	100.0	346.8	Y	1	50

Aspirating Pipets, Individually Packaged with interal sleeves (Paper/Plastic)

Cat. No.	Volume (mL)	Length (mm)	Sterile	Qty. Per Bag	Qty. Per Case
GSP200001	1.0	268.5	Y	100	600
GSP200002	2.0	270.0	Y	100	500
GSP200005	5.0	341.0	Y	50	200
GSP200010	10.0	346.3	Y	50	200
GSP200025	25.0	308.5	Y	50	150
GSP200050	50.0	346.6	Y	30	90
GSP200100	100.0	346.8	Y	10	50

Milk Pipets, Individually Packaged (Paper/Plastic)

Cat. No.	Volume (mL)	Length (mm)	Color Code	Sterile	Package	Qty. Per Bag	Qty. Per Case
GSP010011	1.1	268.5	■	Y	Paper/Plastic	25	1000
GSP020011	1.1	268.5	■	Y	Paper/Plastic	50	500
GSP010022	2.2	272.0	■	Y	Paper/Plastic	50	400

Milk Pipets, Bulk Vacuum-packed

Cat. No.	Volume (mL)	Length (mm)	Color Code	Sterile	Package	Qty. Per Bag	Qty. Per Case
GSP011011	1.1	268.5	■	Y	Paper/Plastic	1000	1000
GSP021011	1.1	268.5	■	Y	Paper/Plastic	250	250
GSP011022	2.2	272.0	■	Y	Paper/Plastic	250	250

Disposable Sampling Tubes

Suitable for the collection, transportation and storage of samples. In addition to COVID-19 samples, they can also be used to preserve various virus samples such as those of influenza, avian influenza, HPV, and hand, foot and mouth disease.

- Materials: Tube Body: Polypropylene (PP), Tube Cap: High-density polyethylene (HDPE), conforming to USP Class VI standards

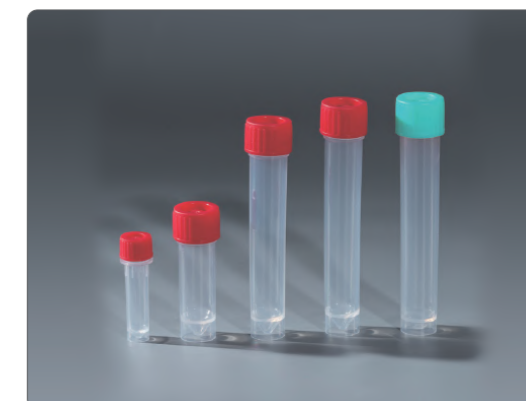

Features

- Conical bottom design facilitates easy pouring and reduces residue
- Spiral seal, manufactured with a unique structural design and process, prevents liquid leakage

Cat. No.	Volume (mL)	Bottom	Cap Color	Sterile	Tube Per Bag	Cap Per Bag
CYT001005	5.0	Self-standing	■	N	1000	1000
CYT001010	10.0	Self-standing	■	N	500	500
CYT001030	30.0	Self-standing	■	N	700	700
CYT002030	30.0	Self-standing	■	N	700	700

Transfer Pipets

Transfer pipets are often used in cell experiments, clinical experiments, cloning experiments and other operations for absorbing, transferring or carrying small amounts of liquid.

- Specifications: 0.2 mL 1.0 mL 3.0 mL 6.0 mL
- Packaging: Single Packed Box Bulk
- Materials: Polyethylene (PE), conforming to USP Class VI standards

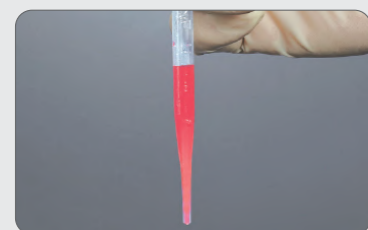
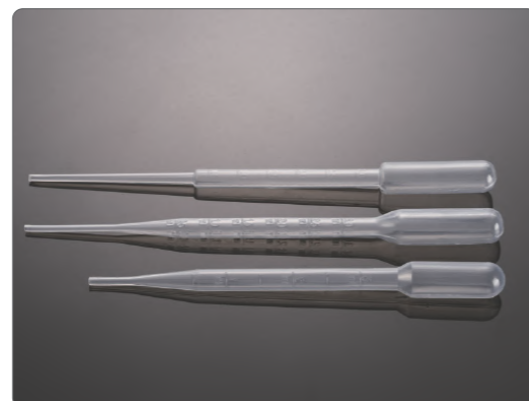

The orifice can be heat-sealed for easy carrying of liquids

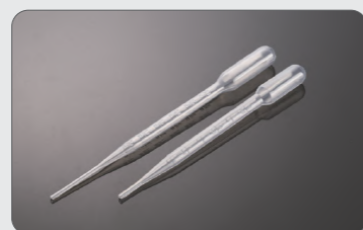

The pipet body is slender and flexible, and can be bent for easy access to micro-volume and special containers

Features

- Various capacities and specifications are available
- The pipet body is translucent and bright white with good fluid flow along the pipet wall, ensuring strong controllability
- Can be used in liquid nitrogen environments
- The pipet body is slender and flexible, and can be bent for easy access to micro-volume and special containers
- Small tip ensures repeatability of drop volume
- The pipet head can be heat-sealed for easy carrying of liquids
- Each pipet is printed with the lot No. for quality traceability
- Sterilized and non-sterilized available, sterilized by irradiation to SAL 10⁻⁶
- DNase/RNase-free, non-pyrogenic

Bulk Package

Cat. No.	Capacity (mL)	Length (mm)	Packaging	Sterile	Qty. Per Bag	Qty. Per Case
PP000002	0.2	68.0	Bulk	N	100	10000
PP000010	1.0	150.0	Bulk	N	100	5000
PP102010	1.0	150.0	Bulk	Y	20	4000
PP000030	3.0	155.0	Bulk	N	100	5000
PP003030	3.0 (Extra-long)	180.0	Bulk	N	100	5000
PP001002	0.2	68.0	Bulk	Y	100	10000
PP001010	1.0	150.0	Bulk	Y	100	5000
PP001030	3.0	155.0	Bulk	Y	100	5000
PP002030	3.0 (Extra-long)	180.0	Bulk	Y	100	5000
PP000060	6.0	225.0	Bulk	N	100	10000
PP001060	6.0	225.0	Bulk	Y	100	5000
PP100060	6.0	225.0	Bulk	N	100	5000
PP101060	6.0	225.0	Bulk	Y	100	5000

Individually Packaged

Cat. No.	Capacity (mL)	Length (mm)	Packaging	Sterile	Qty. Per Bag	Qty. Per Case
PP101002	0.2	68.0	Individual	Y	1	5000
PP101010	1.0	150.0	Individual	Y	1	4000
PP101030	3.0	155.0	Individual	Y	1	4000
PP102030	3.0 (Extra-long)	180.0	Individual	Y	1	4000
PP112030	3.0 (Extra-long)	180.0	Individual	Y	1	4000

Individually Wrapped In Box

Cat. No.	Capacity (mL)	Length (mm)	Packaging	Sterile	Qty. Per Box	Qty. Per Case
PP201010	1.0	150.0	Single(Plastic/Plastic)	Y	1	2000
PP205010	1.0	150.0	Single(Paper/Plastic)	Y	1	2000
PP200010	1.0	150.0	Multiple	N	200	2000
PP200030	3.0	155.0	Multiple	N	200	2000
PP201030	3.0	155.0	Single(Plastic/Plastic)	Y	1	2000
PP205030	3.0	155.0	Single(Paper/Plastic)	Y	1	2000
PP202030	3.0 (Extra-long)	180.0	Single(Plastic/Plastic)	Y	200	2000
PP203030	3.0 (Extra-long)	180.0	Single(Paper/Plastic)	Y	1	2000
PP303030	3.0 (Extra-long)	180.0	Multiple	N	200	2000

Square Media Bottles

The media bottles are made of high-transparency polyethylene terephthalate glycol (PETG), and are suitable for storing and transporting liquid culture medium, solution and serum.

- Specification: 30 mL 60 mL 125 mL 250 mL 500 mL 1000 mL 2000 mL
- Materials: Bottle Body: Polyethylene terephthalate glycol (PETG), Bottle Cap: High-density polyethylene (HDPE), conforming to USP Class VI standards



Features

- A square-shaped design, easy to hold and saves space
- Highly transparent with clear and accurate graduations
- Thick bottle wall, durable, fall-resistant, puncture resistant, resistant to strong pressure, and does not deform easily
- Extremely low extractable levels and excellent biosafety
- Good chemical resistance, which effectively prevents CO₂ and O₂ gas penetration and maintains PH stability
- Working temperature range: -80°C–60°C
- Sterilized by irradiation, SAL 10⁻⁶
- DNase/RNase-free, non-pyrogenic and non-cytotoxic

Cat. No.	Capacity (mL)	Characteristics	Sterile	Inner Diameter of Bottle Neck (mm)	Outer Diameter (mm)	Height with Cap (mm)	Qty. Per Tray	Qty. Per Case
SSB010030	30	With cap	Y	13.8	38.2 square	62.5	24	96
SSB010060	60	With cap	Y	18.0	40.4 square	82.5	24	96
SSB010125	125	With cap	Y	28.6	53 square	106.5	24	96
SSB010250	250	With cap	Y	28.6	59 square	144.0	24	96
SSB130500	500	With cap	Y	28.6	74 square	178.5	24	48
SSB010000	1000	With cap	Y	28.6	92 square	217.0	24	24
SSB010002	2000	With cap	Y	47.2	115.5 square	270.0	6	12
SSB130002	2000	With cap	Y	47.2	115.5 square	270.0	1	12

Solution Bottles

The solution bottles offered by JET BIOFIL are made of high-quality polymer polystyrene through a special production process. They are widely used for the storage and preparation of various liquid formulations in the laboratory, including culture solutions, serums, reagents, etc.

- ◎ Specification: 150 mL 250 mL 500 mL 1000 mL 2000 mL
- ◎ Materials: Bottle Body: Polystyrene (PS),
Bottle Cap: High-density polyethylene (HDPE), conforming to USP Class VI standards

Features

- ◎ Excellent transparency and clear scale for easy volume observation
- ◎ Ergonomic design on both sides for easy holding
- ◎ Made of polystyrene for excellent transparency; solid structure and light weight
- ◎ Clear scale on bottle wall facilitates observation and recognition
- ◎ Wide-mouth design facilitates liquid pouring
- ◎ Resistant to weak acids and weak alkalis
- ◎ Each package bag is printed with the product lot No. for quality traceability
- ◎ 100% undergone for production line air tightness test
- ◎ Sterilized by irradiation, SAL 10⁻⁶
- ◎ DNase/RNase-free, non-pyrogenic



Cat. No.	Volume (mL)	Sterile	Qty. Per Bag	Qty. Per Case
CTF010150	150	Y	1	24
CTF010250	250	Y	1	24
CTF010500	500	Y	1	24
CTF010001	1000	Y	1	24
CTF010002	2000	Y	1	12

Reagent Bottles

Reagent Bottles are suitable for the packaging and long-term storage of biological reagents. Jet Biofil's Reagent Bottles are made from premium polypropylene or polyethylene materials with good physical and chemical properties. Products are highly resistant to compression, impact, and acids. They comply with ISO 9001 and ISO 13485 quality management systems and are manufactured in a Class 100,000 cleanroom environment, ideal for storing various biological reagents used in molecular biology, cell biology, and clinical laboratory medicine.

- ◎ Product Types: Wide-Mouth Narrow-Mouth
- ◎ Specification: 8mL 15mL 30mL 60mL 125mL 250mL 500mL 1000mL
- ◎ Color: Natural Brown
- ◎ Materials: Polypropylene (PP)/High-Density Polyethylene (HDPE), conforming to USP Class VI standards



Features

- ◎ Premium raw materials with excellent physical and chemical properties and non-cytotoxic
- ◎ Available in various volumes and colors, brown color bottles provide excellent light-blocking capabilities, suitable for light-sensitive substances
- ◎ Leakproof design provides excellent sealing without inner caps or liners, and the wide diameter mouth allows easy liquid handling
- ◎ Bottle body has a uniform thickness, with smooth inner and outer surfaces to reduce sample loss, while also being comfortable to hold
- ◎ PP bottles have a temperature tolerance range of -20°C to 121°C and are suitable for autoclaving; HDPE bottles have a temperature tolerance range of -80°C to 60°C and are suitable for freezer storage
- ◎ DNase/RNase-free, non-pyrogenic

Wide-Mouth Reagent Bottles

Cat.No.	Volume (mL)	Material	Color	Dimension			Weight (g)	Sterile	Qty. Per Bag	Qty. Per Case
				Bottle Diameter (mm)	Height (mm)	Diameter (mm)				
PRB000008	8	PP	Natural	24.8	43.0	17.4	6.0	N	100	1500
PRB000015	15	PP	Natural	24.8	56.0	17.4	7.0	N	100	1200
PRB000030	30	PP	Natural	34.2	59.2	24.9	10.8	N	100	1000
PRB000060	60	PP	Natural	39.0	81.5	24.9	14.4	N	100	500
PRB000125	125	PP	Natural	50.7	95.7	32.2	24.4	N	50	250
PRB000250	250	PP	Natural	60.9	127.0	36.9	37.5	N	25	200
PRB000500	500	PP	Natural	73.2	162.3	47.6	66.1	N	12	108
PRB000000	1000	PP	Natural	91.9	193.9	47.6	90.2	N	6	84
PRB010008	8	PP	Brown	24.8	43.0	17.4	6.0	N	100	1500
PRB010015	15	PP	Brown	24.8	56.0	17.4	7.0	N	100	1200
PRB010030	30	PP	Brown	34.2	59.2	24.9	10.8	N	100	1000
PRB010060	60	PP	Brown	39.0	81.5	24.9	14.4	N	100	500
PRB010125	125	PP	Brown	50.7	95.7	32.2	24.4	N	50	250
PRB010250	250	PP	Brown	60.9	127.0	36.9	37.5	N	25	200
PRB010500	500	PP	Brown	73.2	162.3	47.6	66.1	N	12	108
PRB010000	1000	PP	Brown	91.9	193.9	47.6	90.2	N	6	84
PRB001008	8	HDPE	Natural	24.8	43.0	17.4	6.0	N	100	1500
PRB001015	15	HDPE	Natural	24.8	56.0	17.4	7.0	N	100	1200
PRB001030	30	HDPE	Natural	34.2	59.2	24.9	10.8	N	100	1000
PRB001060	60	HDPE	Natural	39.0	81.5	24.9	14.4	N	100	500
PRB001125	125	HDPE	Natural	50.7	95.7	32.2	24.4	N	50	250
PRB001250	250	HDPE	Natural	60.9	127.0	36.9	37.5	N	25	200
PRB001500	500	HDPE	Natural	73.2	162.3	47.6	66.1	N	12	108
PRB001000	1000	HDPE	Brown	91.9	193.9	47.6	90.2	N	6	84
PRB011008	8	HDPE	Brown	24.8	43.0	17.4	6.0	N	100	1500
PRB011015	15	HDPE	Brown	24.8	56.0	17.4	7.0	N	100	1200
PRB011030	30	HDPE	Brown	34.2	59.2	24.9	10.8	N	100	1000
PRB011060	60	HDPE	Brown	39.0	81.5	24.9	14.4	N	100	500
PRB011125	125	HDPE	Brown	50.7	95.7	32.2	24.4	N	50	250
PRB011250	250	HDPE	Brown	60.9	127.0	36.9	37.5	N	25	200
PRB011500	500	HDPE	Brown	73.2	162.3	47.6	66.1	N	12	108
PRB011000	1000	HDPE	Brown	91.9	193.9	47.6	90.2	N	6	84
PRB200008	8	PP	Natural	24.8	43.0	17.4	6.0	Y	20	400
PRB200015	15	PP	Natural	24.8	56.0	17.4	7.0	Y	20	400
PRB200030	30	PP	Natural	34.2	59.2	24.9	10.8	Y	10	200
PRB200060	60	PP	Natural	39.0	81.5	24.9	14.4	Y	10	200
PRB200125	125	PP	Natural	50.7	95.7	32.2	24.4	Y	10	100
PRB200250	250	PP	Natural	60.9	127.0	36.9	37.5	Y	10	100
PRB200500	500	PP	Natural	73.2	162.3	47.6	66.1	Y	5	50
PRB200000	1000	PP	Natural	91.9	193.9	47.6	90.2	Y	3	27
PRB210008	8	PP	Brown	24.8	43.0	17.4	6.0	Y	20	400
PRB210015	15	PP	Brown	24.8	56.0	17.4	7.0	Y	20	400
PRB210030	30	PP	Brown	34.2	59.2	24.9	10.8	Y	10	200
PRB210060	60	PP	Brown	39.0	81.5	24.9	14.4	Y	10	200
PRB210125	125	PP	Brown	50.7	95.7	32.2	24.4	Y	10	100
PRB210250	250	PP	Brown	60.9	127.0	36.9	37.5	Y	10	100
PRB210500	500	PP	Brown	73.2	162.3	47.6	66.1	Y	5	50
PRB210000	1000	PP	Brown	91.9	193.9	47.6	90.2	Y	3	27
PRB201008	8	HDPE	Natural	24.8	43.0	17.4	6.0	Y	10	200
PRB201015	15	HDPE	Natural	24.8	56.0	17.4	7.0	Y	10	200
PRB201030	30	HDPE	Natural	34.2	59.2	24.9	10.8	Y	10	200
PRB201060	60	HDPE	Natural	39.0	81.5	24.9	14.4	Y	10	200
PRB201125	125	HDPE	Natural	50.7	95.7	32.2	24.4	Y	10	100
PRB201250	250	HDPE	Natural	60.9	127.0	36.9	37.5	Y	10	100
PRB201500	500	HDPE	Natural	73.2	162.3	47.6	66.1	Y	5	50
PRB201000	1000	HDPE	Natural	91.9	193.9	47.6	90.2	Y	3	27

Cat.No.	Volume (mL)	Material	Color	Dimension			Weight (g)	Sterile	Qty. Per Bag	Qty. Per Case
				Bottle Diameter (mm)	Height (mm)	Diameter (mm)				
PRB211008	8	HDPE	Brown	24.8	43.0	17.4	6.0	Y	10	200
PRB211015	15	HDPE	Brown	24.8	56.0	17.4	7.0	Y	10	200
PRB211030	30	HDPE	Brown	34.2	59.2	24.9	10.8	Y	10	200
PRB211060	60	HDPE	Brown	39.0	81.5	24.9	14.4	Y	10	200
PRB211125	125	HDPE	Brown	50.7	95.7	32.2	24.4	Y	10	100
PRB211250	250	HDPE	Brown	60.9	127.0	36.9	37.5	Y	10	100
PRB211500	500	HDPE	Brown	73.2	162.3	47.6	66.1	Y	5	50
PRB211000	1000	HDPE	Brown	91.9	193.9	47.6	90.2	Y	3	27

Wide-Mouth Reagent Bottles (Cap and Bottle Separately Packed)

Cat.No.	Volume (mL)	Material	Color	Dimension			Weight (g)	Sterile	Qty. Per Bag	Qty. Per Case
				Bottle Diameter (mm)	Height (mm)	Diameter (mm)				
PRB400008	8	PP	Natural	24.8	43.0	17.4	6.0	Y	100	1500
PRB400015	15	PP	Natural	24.8	56.0	17.4	7.0	Y	100	1200
PRB400030	30	PP	Natural	34.2	59.2	24.9	10.8	Y	100	1000
PRB400060	60	PP	Natural	39.0	81.5	24.9	14.4	Y	100	500
PRB400125	125	PP	Natural	50.7	95.7	32.2	24.4	Y	50	250
PRB400250	250	PP	Natural	60.9	127.0	36.9	37.5	Y	25	200
PRB400500	500	PP	Natural	73.2	162.3	47.6	66.1	Y	12	108
PRB400000	1000	PP	Natural	91.9	193.9	47.6	90.2	Y	6	84
PRB410008	8	PP	Brown	24.8	43.0	17.4	6.0	Y	100	1500
PRB410015	15	PP	Brown	24.8	56.0	17.4	7.0	Y	100	1200
PRB410030	30	PP	Brown	34.2	59.2	24.9	10.8	Y	100	1000
PRB410060	60	PP	Brown	39.0	81.5	24.9	14.4	Y	100	500
PRB410125	125	PP	Brown	50.7	95.7	32.2	24.4	Y	50	250
PRB410250	250	PP	Brown	60.9	127.0	36.9	37.5	Y	25	200
PRB410500	500	PP	Brown	73.2	162.3	47.6	66.1	Y	12	108
PRB410000	1000	PP	Brown	91.9	193.9	47.6	90.2	Y	6	84
PRB401008	8	HDPE	Natural	24.8	43.0	17.4	6.0	Y	100	1500
PRB401015	15	HDPE	Natural	24.8	56.0	17.4	7.0	Y	100	1200
PRB401030	30	HDPE	Natural	34.2	59.2	24.9	10.8	Y	100	1000
PRB401060	60	HDPE	Natural	39.0	81.5	24.9	14.4	Y	100	500
PRB401125	125	HDPE	Natural	50.7	95.7	32.2	24.4	Y	50	250
PRB401250	250	HDPE	Natural	60.9	127.0	36.9	37.5	Y	25	200
PRB401500	500	HDPE	Natural	73.2	162.3	47.6	66.1	Y	12	108
PRB401000	1000	HDPE	Natural	91.9	193.9	47.6	90.2	Y	6	84
PRB411008	8	HDPE	Brown	24.8	43.0	17.4	6.0	Y	100	1500
PRB411015	15	HDPE	Brown	24.8	56.0	17.4	7.0	Y	100	1200
PRB411030	30	HDPE	Brown	34.2	59.2	24.9	10.8	Y	100	1000
PRB411060	60	HDPE	Brown	39.0	81.5	24.9	14.4	Y	100	500
PRB411125	125	HDPE	Brown	50.7	95.7	32.2	24.4	Y	50	250
PRB411250	250	HDPE	Brown	60.9	127.0	36.9	37.5	Y	25	200
PRB411500	500	HDPE	Brown	73.2	162.3	47.6	66.1	Y	12	108
PRB411000	1000	HDPE	Brown	91.9	193.9	47.6	90.2	Y	6	84

Narrow-Mouth Reagent Bottles

Cat.No.	Volume (mL)	Material	Color	Dimension			Weight (g)	Sterile	Qty. Per Bag	Qty. Per Case
				Bottle Diameter (mm)	Height (mm)	Diameter (mm)				
PRB100030	30	PP	Natural	61.0	34.0	17.4	9.4	N	100	1000
PRB100060	60	PP	Natural	84.3	39.0	17.4	13.1	N	100	500
PRB100125	125	PP	Natural	97.9	50.4	21.2	18.7	N	50	250
PRB100250	250	PP	Natural	130.0	60.8	24.9	31.4	N	25	200
PRB100500	500	PP	Natural	167.8	72.6	25.0	53.7	N	12	108

Cat.No.	Volume (mL)	Material	Color	Dimension			Weight (g)	Sterile	Qty. Per Bag	Qty. Per Case
				Bottle Diameter (mm)	Height (mm)	Diameter (mm)				
PRB100000	1000	PP	Natural	212.0	92.0	34.0	94.0	N	6	84
PRB110030	30	PP	Brown	61.0	34.0	17.4	9.4	N	100	1000
PRB110060	60	PP	Brown	84.3	39.0	17.4	13.1	N	100	500
PRB110125	125	PP	Brown	97.9	50.4	21.2	18.7	N	50	250
PRB110250	250	PP	Brown	130.0	60.8	24.9	31.4	N	25	200
PRB110500	500	PP	Brown	167.8	72.6	25.0	53.7	N	12	108
PRB110000	1000	PP	Brown	212.0	92.0	34.0	94.0	N	6	84
PRB1101030	30	HDPE	Natural	61.0	34.0	17.4	9.4	N	100	1000
PRB1101060	60	HDPE	Natural	84.3	39.0	17.4	13.1	N	100	500
PRB1101125	125	HDPE	Natural	97.9	50.4	21.2	18.7	N	50	250
PRB1101250	250	HDPE	Natural	130.0	60.8	24.9	31.4	N	25	200
PRB1101500	500	HDPE	Natural	167.8	72.6	25.0	53.7	N	12	108
PRB1101000	1000	HDPE	Natural	212.0	92.0	34.0	94.0	N	6	84
PRB111030	30	HDPE	Brown	61.0	34.0	17.4	9.4	N	100	1000
PRB111060	60	HDPE	Brown	84.3	39.0	17.4	13.1	N	100	500
PRB111125	125	HDPE	Brown	97.9	50.4	21.2	18.7	N	50	250
PRB111250	250	HDPE	Brown	130.0	60.8	24.9	31.4	N	25	200
PRB111500	500	HDPE	Brown	167.8	72.6	25.0	53.7	N	12	108
PRB111000	1000	HDPE	Brown	212.0	92.0	34.0	94.0	N	6	84
PRB300030	30	PP	Natural	61.0	34.0	17.4	9.4	Y	10	200
PRB300060	60	PP	Natural	84.3	39.0	17.4	13.1	Y	10	200
PRB300125	125	PP	Natural	97.9	50.4	21.2	18.7	Y	10	100
PRB300250	250	PP	Natural	130.0	60.8	24.9	31.4	Y	10	100
PRB300500	500	PP	Natural	167.8	72.6	25.0	53.7	Y	5	50
PRB300000	1000	PP	Natural	212.0	92.0	34.0	94.0	Y	3	30
PRB310030	30	PP	Brown	61.0	34.0	17.4	9.4	Y	10	200
PRB310060	60	PP	Brown	84.3	39.0	17.4	13.1	Y	10	200
PRB310125	125	PP	Brown	97.9	50.4	21.2	18.7	Y	10	100
PRB310250	250	PP	Brown	130.0	60.8	24.9	31.4	Y	10	100
PRB310500	500	PP	Brown	167.8	72.6	25.0	53.7	Y	5	50
PRB310000	1000	PP	Brown	212.0	92.0	34.0	94.0	Y	3	30
PRB301030	30	HDPE	Natural	61.0	34.0	17.4	9.4	Y	10	200
PRB301060	60	HDPE	Natural	84.3	39.0	17.4	13.1	Y	10	200
PRB301125	125	HDPE	Natural	97.9	50.4	21.2	18.7	Y	10	100
PRB301250	250	HDPE	Natural	130.0	60.8	24.9	31.4	Y	10	100
PRB301500	500	HDPE	Natural	167.8	72.6	25.0	53.7	Y	5	50
PRB301000	1000	HDPE	Natural	212.0	92.0	34.0	94.0	Y	3	30
PRB311030	30	HDPE	Brown	61.0	34.0	17.4	9.4	Y	10	200
PRB311060	60	HDPE	Brown	84.3	39.0	17.4	13.1	Y	10	200
PRB311125	125	HDPE	Brown	97.9	50.4	21.2	18.7	Y	10	100
PRB311250	250	HDPE	Brown	130.0	60.8	24.9	31.4	Y	10	100
PRB311500	500	HDPE	Brown	167.8	72.6	25.0	53.7	Y	5	50
PRB311000	1000	HDPE	Brown	212.0	92.0	34.0	94.0	Y	3	30

Narrow-Mouth Reagent Bottles(Cap and Bottle Separately Packed)

Cat.No.	Volume (mL)	Material	Color	Dimension			Weight (g)	Sterile	Qty. Per Bag	Qty. Per Case
				Bottle Diameter (mm)	Height (mm)	Diameter (mm)				
PRB500030	30	PP	Natural	61.0	34.0	17.4	9.4	Y	100	1000
PRB500060	60	PP	Natural	84.3	39.0	17.4	13.1	Y	100	500
PRB500125	125	PP	Natural	97.9	50.4	21.2	18.7	Y	50	250
PRB500250	250	PP	Natural	130.0	60.8	24.9	31.4	Y	25	200
PRB500500	500	PP	Natural	167.8	72.6	25.0	53.7	Y	12	108
PRB500000	1000	PP	Natural	212.0	92.0	34.0	94.0	Y	6	84

Cat.No.	Volume (mL)	Material	Color	Dimension			Weight (g)	Sterile	Qty. Per Bag	Qty. Per Case
				Bottle Diameter (mm)	Height (mm)	Diameter (mm)				
PRB510030	30	PP	Brown	61.0	34.0	17.4	9.4	Y	100	1000
PRB510060	60	PP	Brown	84.3	39.0	17.4	13.1	Y	100	500
PRB510125	125	PP	Brown	97.9	50.4	21.2	18.7	Y	50	250
PRB510250	250	PP	Brown	130.0	60.8	24.9	31.4	Y	25	200
PRB510500	500	PP	Brown	167.8	72.6	25.0	53.7	Y	12	108
PRB510000	1000	PP	Brown	212.0	92.0	34.0	94.0	Y	6	84
PRB501030	30	HDPE	Natural	61.0	34.0	17.4	9.4	Y	100	1000
PRB501060	60	HDPE	Natural	84.3	39.0	17.4	13.1	Y	100	500
PRB501125	125	HDPE	Natural	97.9	50.4	21.2	18.7	Y	50	250
PRB501250	250	HDPE	Natural	130.0	60.8	24.9	31.4	Y	25	200
PRB501500	500	HDPE	Natural	167.8	72.6	25.0	53.7	Y	12	108
PRB501000	1000	HDPE	Natural	212.0	92.0	34.0	94.0	Y	6	84
PRB511030	30	HDPE	Brown	61.0	34.0	17.4	9.4	Y	100	1000
PRB511060	60	HDPE	Brown	84.3	39.0	17.4	13.1	Y	100	500
PRB511125	125	HDPE	Brown	97.9	50.4	21.2	18.7	Y	50	250
PRB511250	250	HDPE	Brown	130.0	60.8	24.9	31.4	Y	25	200
PRB511500	500	HDPE	Brown	167.8	72.6	25.0	53.7	Y	12	108
PRB511000	1000	HDPE	Brown	212.0	92.0	34.0	94.0	Y	6	84



Stock code: 688026

Filtration

Membrane separation is considered one of the most promising high technologies from the end of the 20th century to the middle of the 21st century. Compared with other traditional separation methods, membrane separation is an economic, energy-saving and efficient technology with the advantages of a simple process, large separation coefficient, continuous operation at room temperature, direct amplification, and specificity of the membrane but without phase change and secondary contamination. With the continuous development of membrane separation technology, microfiltration, ultrafiltration and other membrane technologies have been widely used in biomedicine, biotechnology, energy engineering and other fields.

Microfiltration (MF)

Microfiltration, also known as microporous filtration, is a type of polishing filtration with a mechanism that is based on the sieving separation process. Microfiltration membranes are made of organic or inorganic materials. They are mainly used to remove particles, bacteria and other contaminants from the gas and liquid phases to achieve the purposes of purification, separation and concentration. Mycoplasma can be removed with 0.1 μm filters; most culture media, buffers, biofluids, and gases can be sterilized with 0.2 or 0.22 μm filters in routine laboratory tests; 0.45 μm filter membranes are preferred for the clarification and primary filtration of solutions and solvents. Filters produced by JET BIOFIL include syringe filters driven by positive pressure, vacuum bottle filters, etc., which can meet different demands for sterile filtration of culture media, buffers and reagents due to rich product forms and a variety of membrane materials.

Ultrafiltration (UF)

Ultrafiltration is a membrane separation technology with a pore size between that of microfiltration and nanofiltration. Ultrafiltration purifies, separates, and concentrates solutions based on the mechanism of the sieving process and is related to the membrane pore size ranging from 0.05 μm to 1 nm. The disposable centrifugal filters produced by JET BIOFIL are provided with polyethersulfone (PES) membranes with different molecular weight cutoffs (MWCs), which are characterized by low protein binding capacity and high throughput, and can be widely used for the concentration and desalination of biological samples, as well as buffer replacement.

Syringe Filters

Syringe filters, used with disposable syringes, are a fast, convenient and reliable filter processing device routinely used in laboratories for small-volume samples. They are mainly used in pre-filtration of samples, laboratory sterilization and filtration of biological fluids, media and media additives, sample preparation, and gas filtration. JET BIOFIL syringe filters are available in various sizes and membrane configurations for sterile and non-sterile laboratory operations.

- Diameter Specifications: 13 mm 25 mm 30 mm
- Membrane Pore Size: 0.1 μm 0.22 μm 0.45 μm
- Membrane Type: MCE Nylon PVDF PES PTFE CA GF+CA SFCA PES Express
- Materials: Shell: Polypropylene (PP), conforming to USP Class VI standards



For use with disposable syringes

Different color outer rings correspond to different membrane types, and are easy to distinguish and identify

Features

- Single package and bulk packaging are available for different customer requirements
- Various membrane types and filtration diameters available
- Female Luer connector inlet and male Luer connector outlet
- Polypropylene shell comes with a color ring to distinguish filters of different materials
- Each batch undergoes rigorous integrity test
- Sterilized and non-sterilized available, sterilized by irradiation to SAL 10^{-6}
- DNase/RNase-free, non-pyrogenic

Syringe Filters, Sterile, Individually Packed

Cat. No.	Membrane Material	Color	Pore Size (µm)	Housing Diameter (mm)	Sterile	Qty. Per Box	Qty. Per Case
FMC201013	MCE	○	0.22	13.0	Y	100	800
FMC201025		○	0.22	25.0	Y	45	360
FMC201030		○	0.22	30.0	Y	45	360
FMC401013		○	0.45	13.0	Y	100	800
FMC401025		○	0.45	25.0	Y	45	360
FMC401030		○	0.45	30.0	Y	45	360
FPV103013	PVDF	○	0.10	13.0	Y	100	800
FPV103025		○	0.10	25.0	Y	45	360
FPV103030		○	0.10	30.0	Y	45	360
FPV203013		○	0.22	13.0	Y	100	800
FPV203025		○	0.22	25.0	Y	45	360
FPV203030		○	0.22	30.0	Y	45	360
FPV403013		○	0.45	13.0	Y	100	800
FPV403025		○	0.45	25.0	Y	45	360
FPV403030		○	0.45	30.0	Y	45	360
PTF205013	PTFE	White	0.22	13.0	Y	100	800
PTF205025		White	0.22	25.0	Y	45	360
PTF205030		White	0.22	30.0	Y	45	360
PTF405013		White	0.45	13.0	Y	100	800
PTF405025		White	0.45	25.0	Y	45	360
PTF405030	White	0.45	30.0	Y	45	360	
FNY202013	NYLON	○	0.22	13.0	Y	100	800
FNY202025		○	0.22	25.0	Y	45	360
FNY202030		○	0.22	30.0	Y	45	360
FNY402013		○	0.45	13.0	Y	100	800
FNY402025	○	0.45	25.0	Y	45	360	
FNY402030	○	0.45	30.0	Y	45	360	
FPE204013	PES	○	0.22	13.0	Y	100	800
FPE204025		○	0.22	25.0	Y	45	360
FPE204030		○	0.22	30.0	Y	45	360
FPE404013		○	0.45	13.0	Y	100	800
FPE404025		○	0.45	25.0	Y	45	360
FPE404030		○	0.45	30.0	Y	45	360
FCA206013	CA	○	0.22	13.0	Y	100	800
FCA206025		○	0.22	25.0	Y	45	360
FCA206030		○	0.22	30.0	Y	45	360
FCA406013		○	0.45	13.0	Y	100	800
FCA406025		○	0.45	25.0	Y	45	360
FCA406030		○	0.45	30.0	Y	45	360

Cat. No.	Membrane Material	Color	Pore Size (µm)	Housing Diameter (mm)	Sterile	Qty. Per Box	Qty. Per Case
SCA207013	SFCA	○	0.22	13.0	Y	100	800
SCA207025		○	0.22	25.0	Y	45	360
SCA207030		○	0.22	30.0	Y	45	360
SCA407013		○	0.45	13.0	Y	100	800
SCA407025		○	0.45	25.0	Y	45	360
SCA407030		○	0.45	30.0	Y	45	360
FPE204113	PES Express	○	0.22	13.0	Y	100	800
FPE204125		○	0.22	25.0	Y	45	360
FPE204130		○	0.22	30.0	Y	45	360
FPE404113		○	0.45	13.0	Y	100	800
FPE404125		○	0.45	25.0	Y	45	360
FPE404130		○	0.45	30.0	Y	45	360
GFA201025	GF+CA	Natural	GF1.1µm+CA0.22µm	25.0	Y	45	360
GFA201030		Natural	GF1.1µm+CA0.22µm	30.0	Y	45	360
GFA401025		Natural	GF1.1µm+CA0.45µm	25.0	Y	45	360
GFA401030		Natural	GF1.1µm+CA0.45µm	30.0	Y	45	360

Syringe Filters, Sterile, Bulk Packed

Cat. No.	Membrane Material	Color	Pore Size (µm)	Housing Diameter (mm)	Sterile	Qty. Per Box	Qty. Per Case
FMC211013	MCE	○	0.22	13.0	Y	100	1000
FMC211025		○	0.22	25.0	Y	50	500
FMC211030		○	0.22	30.0	Y	50	500
FMC411013		○	0.45	13.0	Y	100	1000
FMC411025		○	0.45	25.0	Y	50	500
FMC411030		○	0.45	30.0	Y	50	500
FPV113013	PVDF	○	0.10	13.0	Y	100	1000
FPV113025		○	0.10	25.0	Y	50	500
FPV113030		○	0.10	30.0	Y	50	500
FPV213013		○	0.22	13.0	Y	100	1000
FPV213025		○	0.22	25.0	Y	50	500
FPV213030		○	0.22	30.0	Y	50	500
FPV413013		○	0.45	13.0	Y	100	1000
FPV413025		○	0.45	25.0	Y	50	500
FPV413030		○	0.45	30.0	Y	50	500
PTF215013	PTFE	White	0.22	13.0	Y	100	1000
PTF215025		White	0.22	25.0	Y	50	500
PTF215030		White	0.22	30.0	Y	50	500
PTF415013		White	0.45	13.0	Y	100	1000
PTF415025		White	0.45	25.0	Y	50	500
PTF415030	White	0.45	30.0	Y	50	500	
FNY212013	NYLON	○	0.22	13.0	Y	100	1000
FNY212025		○	0.22	25.0	Y	50	500
FNY212030		○	0.22	30.0	Y	50	500
FNY412013		○	0.45	13.0	Y	100	1000
FNY412025		○	0.45	25.0	Y	50	500
FNY412030		○	0.45	30.0	Y	50	500

Cat. No.	Membrane Material	Color	Pore Size (µm)	Housing Diameter (mm)	Sterile	Qty. Per Box	Qty. Per Case
FPE214013	PES	○	0.22	13.0	Y	100	1000
FPE214025		○	0.22	25.0	Y	50	500
FPE214030		○	0.22	30.0	Y	50	500
FPE414013		○	0.45	13.0	Y	100	1000
FPE414025		○	0.45	25.0	Y	50	500
FPE414030		○	0.45	30.0	Y	50	500
FCA216013	CA	○	0.22	13.0	Y	100	1000
FCA216025		○	0.22	25.0	Y	50	500
FCA216030		○	0.22	30.0	Y	50	500
FCA416013		○	0.45	13.0	Y	100	1000
FCA416025		○	0.45	25.0	Y	50	500
FCA416030		○	0.45	30.0	Y	50	500
SCA217013	SFCA	○	0.22	13.0	Y	100	1000
SCA217025		○	0.22	25.0	Y	50	500
SCA217030		○	0.22	30.0	Y	50	500
SCA417013		○	0.45	13.0	Y	100	1000
SCA417025		○	0.45	25.0	Y	50	500
SCA417030		○	0.45	30.0	Y	50	500

Syringe Filters, Non-Sterile, Bulk Packed

Cat. No.	Membrane Material	Color	Pore Size (µm)	Housing Diameter (mm)	Sterile	Qty. Per Box	Qty. Per Case
FMC221013	MCE	○	0.22	13.0	N	100	1000
FMC221025		○	0.22	25.0	N	50	500
FMC221030		○	0.22	30.0	N	50	500
FMC421013		○	0.45	13.0	N	100	1000
FMC421025		○	0.45	25.0	N	50	500
FMC421030		○	0.45	30.0	N	50	500
FPV123013	PVDF	○	0.10	13.0	N	100	1000
FPV123025		○	0.10	25.0	N	50	500
FPV123030		○	0.10	30.0	N	50	500
FPV223013		○	0.22	13.0	N	100	1000
FPV223025		○	0.22	25.0	N	50	500
FPV223030		○	0.22	30.0	N	50	500
FPV423013	PTFE	○	0.45	13.0	N	100	1000
FPV423025		○	0.45	25.0	N	50	500
FPV423030		○	0.45	30.0	N	50	500
PTF225013		White	0.22	13.0	N	100	1000
PTF225025		White	0.22	25.0	N	50	500
PTF225030		White	0.22	30.0	N	50	500
PTF425013	NYLON	White	0.45	13.0	N	100	1000
PTF425025		White	0.45	25.0	N	50	500
PTF425030		White	0.45	30.0	N	50	500
FNY222013		○	0.22	13.0	N	100	1000
FNY222025		○	0.22	25.0	N	50	500
FNY222030		○	0.22	30.0	N	50	500
FNY422013	PES	○	0.45	13.0	N	100	1000
FNY422025		○	0.45	25.0	N	50	500
FNY422030		○	0.45	30.0	N	50	500
FPE224013		○	0.22	13.0	N	100	1000
FPE224025		○	0.22	25.0	N	50	500
FPE224030		○	0.22	30.0	N	50	500
FPE424013	PES	○	0.45	13.0	N	100	1000
FPE424025		○	0.45	25.0	N	50	500
FPE424030		○	0.45	30.0	N	50	500

Cat. No.	Membrane Material	Color	Pore Size (µm)	Housing Diameter (mm)	Sterile	Qty. Per Box	Qty. Per Case
FCA226013	CA	○	0.22	13.0	N	100	1000
FCA226025		○	0.22	25.0	N	50	500
FCA226030		○	0.22	30.0	N	50	500
FCA426013		○	0.45	13.0	N	100	1000
FCA426025		○	0.45	25.0	N	50	500
FCA426030		○	0.45	30.0	N	50	500
SCA227013	SFCA	○	0.22	13.0	N	100	1000
SCA227025		○	0.22	25.0	N	50	500
SCA227030		○	0.22	30.0	N	50	500
SCA427013		○	0.45	13.0	N	100	1000
SCA427025		○	0.45	25.0	N	50	500
SCA427030		○	0.45	30.0	N	50	500
PTF225050	PTFE	Natural	0.22	50.0	N	1	150
PTF235050		Natural	0.45	50.0	N	1	150
PTF245050		Natural	0.22	50.0	N	1	150
PTF255050		Natural	0.22	50.0	N	1	150
PTF425050		Natural	0.45	50.0	N	10	200
PTF435050		Natural	0.45	50.0	N	10	200

50 mm Syringe Filters

The 50 mm syringe filter's shell is made of polypropylene (PP) and the filter membrane is made of polytetrafluoroethylene (PTFE). The syringe filter is surfactant-free and has a bi-directional filter membrane support combines a single/double stepped barb inlet/outlet for secure syringe loading. The product can be used to filter corrosive chemicals and solvents such as those used in GC and HPLC, as well as for sterile air or CO₂ gas filtration and to protect instruments from aqueous solutions.



- Membrane Pore Size: 0.22 µm 0.45 µm
- Pattern: Single stepped Barb Double stepped Barbs
- Materials: Shell: Polypropylene (PP), Filter Membrane: Polytetrafluoroethylene (PTFE), conforming to USP Class VI standards

Features

- Membrane type and pore size are printed on each filter for easy product traceability
- The products are suitable for filtering gases and are also ideal for filtering corrosive chemicals and solvents
- Filter sample volume: 0.2 L-5.0 L
- 100% undergone for production line air tightness test
- DNase/RNase-free, non-pyrogenic

Individually Packaged

Cat. No.	Connectors	Pore Size (µm)	Compatible Tubing Range	Housing Diameter (mm)	Sterile	Qty. Per Bag	Qty. Per Case
PTF245050	Single Stepped Barb	0.22	1/4"-1/2"ID	50.0	N	1	150
PTF445050		0.45	1/4"-1/2"ID	50.0	N	1	150
PTF255050	Double Stepped Barbs	0.22	1/4"-1/2"ID	50.0	N	1	150
PTF455050		0.45	1/4"-1/2"ID	50.0	N	1	150

Rack Box

Cat. No.	Connectors	Pore Size (µm)	Compatible Tubing Range	Housing Diameter (mm)	Sterile	Qty. Per Bag	Qty. Per Case
PTF225050	Single Stepped Barb	0.22	1/4"-1/2"ID	50.0	N	10	200
PTF425050		0.45	1/4"-1/2"ID	50.0	N	10	200
PTF235050	Double Stepped Barbs	0.22	1/4"-1/2"ID	50.0	N	20	240
PTF435050		0.45	1/4"-1/2"ID	50.0	N	20	240

50 mm Sterilizing Filter

Positive pressure sterilizing filters are widely applicable to sterilizing filtration of aqueous solutions in biological laboratories, and can be used with a peristaltic pump, syringe or other positive pressure device.

JET BIOFIL's 50 mm sterilizing filter is suitable for removing microorganisms, particles, precipitates, and undissolved powders larger than 0.22 µm from aqueous solutions. This product has the stepped hose barb design that ensures stable connection between the filter and the hose. This product is made of 0.22 µm hydrophilic polyethersulfone (PES) membrane and can filter samples up to 8 L in volume. Its excellent filtration performance and reliable sterilization capability provide an efficient solution for the sterilizing filtration of liquids in biological laboratories.



- Membrane diameter: 50 mm
- Membrane pore size: 0.22 µm
- Pattern: Two stepped barbs, filling bell
- Materials:
 - Filter housing: Methyl methacrylate-butadiene-styrene (MBS)
 - Filter Membrane: Hydrophilic polyethersulfone (PES)
 - Filling Bell: Polycarbonate (PC)
 - Filling Bell Cap: Low-density polyethylene (LDPE)
- Conforming to USP Class VI standards

Features

- The filter membrane is made of 0.22 µm hydrophilic polyethersulfone for high throughput and excellent filtration performance
- The products have an effective filtration area of up to 19.9 cm², and can filter samples up to 3.8-8 L in volume
- Maximum operating temperature: 45°C
- Maximum inlet pressure: 3.3 bars (50 psi) at 25°C
- Typical water flow rate: 390 mL/min at 25°C under 15 psi
- It is designed with a filling bell avoiding liquid splashing and pollution
- Stepped hose barb design that ensures stable connection between the filter and the hose
- Filter surface with coding marks, clearly distinguish inlet and outlet
- Sterilized by irradiation, SAL 10⁻⁶, DNase/RNase-free, non-pyrogenic, non-cytotoxic

Special Tips:

The test results show that the 50 mm sterilizing filters are suitable for most aqueous solutions, such as acetic acid (5%), aqueous buffer, cell media, Clorox® bleaching agent (5% solution), sodium hydroxide (10%), sulfuric acid (20%). The unlisted reagents should be tested for applicability before use.

Cat. No.	Description	Adaptive Tube Diameter	Membrane Pore Size (µm)	Membrane Diameter (mm)	Outer Diameter (mm)	Sterile	Qty. Per Bag	Qty. Per Case
FPE305050	PES membrane, two stepped barbs, filling bell	1/2 "-1/4 "ID	0.22	50	62	Y	1	10
FPE315050	PES membrane, two stepped barbs, without filling bell	1/2 "-1/4 "ID	0.22	50	62	Y	1	10

Before using this product, please read this Manual carefully and operate according to the instructions.

Vacuum Bottle Filters

The vacuum bottle filters provide a pressure differential through a vacuum pump, and are used for large-scale filtration of tissue culture fluids and other laboratory solutions. The sample processing volume can be up to several liters, while the filtered sample can be directly stored in a sterile collection bottle. These products are ideal for sterile filtration of culture media, buffers and reagents. A complete vacuum filter set is composed of an upper cup cover, an upper cup, a connector, a filter membrane and a reservoir bottle.

- Membrane Pore Size: 0.10 µm 0.22 µm 0.45 µm
- Membrane Type: MCE Nylon PVDF CA SFCA PES PES Express
- Upper Cup Capacity: 150 mL 250 mL 500 mL 1000 mL
- Reservoir Bottle Capacity: 150 mL 250 mL 500 mL 1000 mL
- Materials: Upper Filter Cup and Reservoir Bottle: Polystyrene (PS), Green Connector: Acrylonitrile-butadiene-styrene copolymer (ABS), White Connector: Polypropylene (PP), conforming to USP Class VI standards



Sloped hose fittings make it easier to connect to vacuum pipelines.

The product is vacuum packed and sterilized by irradiation

The easy-grip design on both sides of the reservoir bottle is ergonomic and easy to hold

A variety of membrane materials and specifications (150 mL, 250 mL, 500 mL, 1000 mL) are available to meet a variety of experimental requirements

Features

- A variety of membrane materials and specifications are available to satisfy different demands for customer applications
- Sloped hose fittings make it easier to connect vacuum pipelines
- The upper cup has a GL-45 thread and fits most glass and plastic media storage bottles
- The easy-grip design on both sides of the reservoir bottle is ergonomic and makes the bottle easy to hold
- Good transparency, clear scale, easy to observe capacity
- PES express has faster filtration and lower clogging rate
- Each bag is printed with the product lot No. for quality traceability
- Sterilized by irradiation, SAL 10⁻⁶
- DNase/RNase-free, non-pyrogenic

Cat. No.	Membrane Material	Pore Size (µm)	Capacity (mL)	Membrane Diameter (mm)	Qty. Per Bag	Qty. Per Case
FPV103150	PVDF	0.10	150	Φ50	1	12
FPV103250		0.10	250	Φ50	1	12
FPV103500		0.10	500	Φ75	1	12
FPV103000		0.10	1000	Φ91	1	12
FPV203150		0.22	150	Φ50	1	12
FPV203250		0.22	250	Φ50	1	12
FPV203500		0.22	500	Φ75	1	12
FPV203000		0.22	1000	Φ91	1	12
FPV403150		0.45	150	Φ50	1	12
FPV403250		0.45	250	Φ50	1	12
FPV403500		0.45	500	Φ75	1	12
FPV403000		0.45	1000	Φ91	1	12

Cat. No.	Membrane Material	Pore Size (µm)	Capacity (mL)	Membrane Diameter (mm)	Qty. Per Bag	Qty. Per Case	
FMC201150	MCE	0.22	150	Φ50	1	12	
FMC201250		0.22	250	Φ50	1	12	
FMC201500		0.22	500	Φ75	1	12	
FMC201000		0.22	1000	Φ91	1	12	
FMC401150		0.45	150	Φ50	1	12	
FMC401250		0.45	250	Φ50	1	12	
FMC401500		0.45	500	Φ75	1	12	
FMC401000		0.45	1000	Φ91	1	12	
FPE104150		PES	0.1	150	Φ50	1	12
FPE104250			0.1	250	Φ50	1	12
FPE104500	0.1		500	Φ75	1	12	
FPE104000	0.1		1000	Φ91	1	12	
FPE204150	0.22		150	Φ50	1	12	
FPE204250	0.22		250	Φ50	1	12	
FPE204500	0.22		500	Φ75	1	12	
FPE204000	0.22		1000	Φ91	1	12	
FPE404150	0.45		150	Φ50	1	12	
FPE404250	0.45		250	Φ50	1	12	
FPE404500	0.45		500	Φ75	1	12	
FPE404000	0.45		1000	Φ91	1	12	
FNY202150	NYLON		0.22	150	Φ50	1	12
FNY202250			0.22	250	Φ50	1	12
FNY202500			0.22	500	Φ75	1	12
FNY202000		0.22	1000	Φ91	1	12	
FNY402150		0.45	150	Φ50	1	12	
FNY402250		0.45	250	Φ50	1	12	
FNY402500		0.45	500	Φ75	1	12	
FNY402000		0.45	1000	Φ91	1	12	
FCA206150		CA	0.22	150	Φ50	1	12
FCA206250			0.22	250	Φ50	1	12
FCA206500	0.22		500	Φ75	1	12	
FCA206000	0.22		1000	Φ91	1	12	
FCA406150	0.45		150	Φ50	1	12	
FCA406250	0.45		250	Φ50	1	12	
FCA406500	0.45		500	Φ75	1	12	
FCA406000	0.45		1000	Φ91	1	12	
FPE234150	PES Express		0.22	150	Φ50	1	12
FPE234250			0.22	250	Φ50	1	12

Cat. No.	Membrane Material	Pore Size (µm)	Capacity (mL)	Membrane Diameter (mm)	Qty. Per Bag	Qty. Per Case
FPE234500	PES Express	0.22	500	Φ75	1	12
FPE234000		0.22	1000	Φ91	1	12
FPE434150		0.45	150	Φ50	1	12
FPE434250		0.45	250	Φ50	1	12
FPE434500		0.45	500	Φ75	1	12
FPE434000		0.45	1000	Φ91	1	12
SCA207150	SFCA	0.22	150	Φ50	1	12
SCA207250		0.22	250	Φ50	1	12
SCA207500		0.22	500	Φ75	1	12
SCA207000		0.22	1000	Φ91	1	12
SCA407250		0.45	250	Φ50	1	12
SCA407150		0.45	150	Φ50	1	12
SCA407500		0.45	500	Φ75	1	12
SCA407000		0.45	1000	Φ91	1	12

Filter Upper Cups

The system uses a vacuum pump to provide differential pressure to filter tissue culture fluids and other laboratory solutions. The filtrate can be directly stored in a sterile collection bottle, significantly shortening the pipetting process and improving efficiency. The Filter Upper Cup includes an upper cup cover, an upper cup, and a connector.

- Membrane pore size: 0.10 µm 0.22 µm 0.45 µm
- Membrane type: MCE Nylon PVDF CA SFCA PES PES express
- Upper cup capacity: 150 mL 250 mL 500 mL 1000 mL
- Materials: Upper filter cup: Polystyrene (PS), Green connector: Acrylonitrile-butadiene-styrene copolymer (ABS), White connector: Polypropylene (PP), conforming to USP Class VI standards



Features

- Offering a variety of membrane materials and numerous specifications to meet different experimental needs
- The inclined hose connector makes it easier to connect to the vacuum pipeline
- The upper cup is equipped with a GL-45 thread, suitable for most glass and plastic culture medium storage bottles
- Good transparency with clear graduation lines for easy volume observation
- Sterilized by irradiation, SAL 10⁻⁶
- DNase/RNase-free, non-pyrogenic

Cat. No.	Membrane Material	Pore Size (µm)	Capacity (mL)	Diameter (mm)	Qty. Per Bag	Qty. Per Case	
FPV113150	PVDF	0.10	150	Φ50	1	24	
FPV113250		0.10	250	Φ50	1	24	
FPV113500		0.10	500	Φ75	1	24	
FPV113000		0.10	1000	Φ91	1	24	
FPV213150		0.22	150	Φ50	1	24	
FPV213250		0.22	250	Φ50	1	24	
FPV213500		0.22	500	Φ75	1	24	
FPV213000		0.22	1000	Φ91	1	24	
FPV413150		0.45	150	Φ50	1	24	
FPV413250		0.45	250	Φ50	1	24	
FPV413500		0.45	500	Φ75	1	24	
FPV413000		0.45	1000	Φ91	1	24	
FMC211150		MCE	0.22	150	Φ50	1	24
FMC211250			0.22	250	Φ50	1	24
FMC211500	0.22		500	Φ75	1	24	
FMC211000	0.22		1000	Φ91	1	24	
FMC411150	0.45		150	Φ50	1	24	
FMC411250	0.45		250	Φ50	1	24	
FMC411500	0.45		500	Φ75	1	24	
FMC411000	0.45		1000	Φ91	1	24	
FPE114150	PES	0.10	150	Φ50	1	24	
FPE114250		0.10	250	Φ50	1	24	
FPE114500		0.10	500	Φ75	1	24	
FPE114000		0.10	1000	Φ91	1	24	
FPE214150		0.22	150	Φ50	1	24	
FPE214250		0.22	250	Φ50	1	24	
FPE214500		0.22	500	Φ75	1	24	
FPE214000		0.22	1000	Φ91	1	24	

Cat. No.	Membrane Material	Pore Size (µm)	Capacity (mL)	Membrane Diameter (mm)	Qty. Per Bag	Qty. Per Case
FPE414150	PES	0.45	150	Φ50	1	24
FPE414250		0.45	250	Φ50	1	24
FPE414500		0.45	500	Φ75	1	24
FPE414000		0.45	1000	Φ91	1	24
FNY212150	NYLON	0.22	150	Φ50	1	24
FNY212250		0.22	250	Φ50	1	24
FNY212500		0.22	500	Φ75	1	24
FNY212000		0.22	1000	Φ91	1	24
FNY412150		0.45	150	Φ50	1	24
FNY412250		0.45	250	Φ50	1	24
FNY412500		0.45	500	Φ75	1	24
FNY412000		0.45	1000	Φ91	1	24
FCA216150	CA	0.22	150	Φ50	1	24
FCA216250		0.22	250	Φ50	1	24
FCA216500		0.22	500	Φ75	1	24
FCA216000		0.22	1000	Φ91	1	24
FCA416150		0.45	150	Φ50	1	24
FCA416250		0.45	250	Φ50	1	24
FCA416500		0.45	500	Φ75	1	24
FCA416000		0.45	1000	Φ91	1	24
SCA217150	SFCA	0.22	150	Φ50	1	24
SCA217250		0.22	250	Φ50	1	24
SCA217500		0.22	500	Φ75	1	24
SCA217000		0.22	1000	Φ91	1	24
SCA417150		0.45	150	Φ50	1	24
SCA417250		0.45	250	Φ50	1	24
SCA417500		0.45	500	Φ75	1	24
SCA417000		0.45	1000	Φ91	1	24
FPE254250	PES Express	0.22	250	Φ75	1	24

Reservoir Bottles

This product can be used with a vacuum filter as a receiving container for vacuum filtered liquids; they can also be used to store and prepare various laboratory fluids, such as culture fluids, serums, and reagents.

- Specification: 150 mL 250 mL 500 mL 1000 mL
- Materials: Bottle Body: Polystyrene (PS), Bottle Cap: High-density Polyethylene (HDPE), conforming to USP Class VI standards



Easy-grip design on both sides, ergonomic and easy to hold

Good transparency, clearly marked scale, easy to observe capacity

Features

- 4 sizes are available: 150, 250, 500, and 1000 mL
- Made of high-quality polymer polystyrene for good transparency, strong structure and light weight
- Clear scale on the flask wall for easy observation and identification
- Designed with a wide mouth for easy pouring
- The size of the receiving flask mouth is based on that of a standard GL45 flask mouth
- Easy-grip design on both sides, ergonomic and easy to hold
- Resistant to weak acids
- 100% undergone for production line air tightness test
- Each bag is marked with the product lot number for easy quality traceability
- Sterilized by irradiation, SAL 10⁻⁶
- DNase/RNase-free, non-pyrogenic

Cat. No.	Material	Capacity (mL)	Sterile	Qty. Per Bag	Qty. Per Case
FRB000150	PS	150	Y	1	24
FRB000250		250	Y	1	24
FRB000500		500	Y	1	24
FRB000000		1000	Y	1	24

Tube Vacuum Filters System

The system uses a vacuum pump to provide differential pressure to filter tissue culture fluids and other laboratory solutions. The filtrate can be directly stored in sterile centrifuge tubes, significantly shortening the pipetting process and improving efficiency. The set includes a vacuum upper filter cup, 50 mL conical centrifuge tube, centrifuge tube holder and centrifuge tube cap.



- Membrane Pore Size: 0.22 µm 0.45 µm
- Membrane Type: MCE Nylon PVDF CA PES
- Upper Cup Capacity: 150 mL
- Lower Tube Capacity: 50 mL
- Materials: Upper filter cup: Polystyrene (PS), Green connector: Acrylonitrile-butadiene-styrene copolymer (ABS), White connector: Polypropylene (PP), conforming to USP Class VI standards

Features

- The 50 mm diameter membrane with external vacuum interface allows for direct filtration into a 50 mL centrifuge tube, reducing unnecessary pipetting steps
- Comes with an individually packaged centrifuge tube cap for easy storage
- The connector thread is attached to a standard 50 mL standing conical centrifuge tube
- The base directly secures the whole filter device
- The set includes: vacuum filter upper cup, 50 mL conical centrifuge tube, centrifuge tube holder and centrifuge tube cap
- Sterilized by irradiation, SAL 10⁻⁶
- DNase/RNase-free, non-pyrogenic

Tube Vacuum Filter System (including tube, cap and stand)

Cat. No.	Membrane Material	Pore Size (µm)	Funnel / Tube Size (mL)	Sterile	Qty. Per Bag	Qty. Per Case
FCF010001	CA	0.45	150/50	Y	1	12
FCF010002		0.22	150/50	Y	1	12
FCF010003	PES	0.45	150/50	Y	1	12
FCF010004		0.22	150/50	Y	1	12
FCF010005	MCE	0.45	150/50	Y	1	12
FCF010006		0.22	150/50	Y	1	12
FCF010007	PVDF	0.45	150/50	Y	1	12
FCF010008		0.22	150/50	Y	1	12
FCF010009	NYLON	0.45	150/50	Y	1	12
FCF010010		0.22	150/50	Y	1	12

Tube Top Vacuum Filters

Using a vacuum pump to provide differential pressure for filtration of tissue culture fluids and other laboratory solutions, the filtrate can be directly stored in sterile centrifuge tubes, greatly shortening the pipetting process and improving efficiency. The set includes: upper cup cover, upper cup and connector.



- Membrane pore size: 0.22 µm 0.45 µm
- Membrane Type: MCE Nylon PVDF CA PES
- Upper cup capacity: 150 mL
- Materials: Upper filter cup: Polystyrene (PS), Green connector: Acrylonitrile-butadiene-styrene copolymer (ABS), White connector: Polypropylene (PP), conforming to USP Class VI standards

Features

- The 50 mm diameter membrane and external vacuum interface allows for direct filtration into a 50 mL centrifuge tube, reducing unnecessary pipetting steps
- Comes with an individually packaged centrifuge tube cap for easy storage
- Connector thread attached to a standard 50 mL standing conical centrifuge tube
- The set includes: cap of tube top vacuum filter, tube top vacuum filter, filter connector
- Sterilized by irradiation, SAL 10⁻⁶
- DNase/RNase-free, non-pyrogenic

Cat. No.	Membrane Material	Pore Size (µm)	Funnel / Tube Size (mL)	Sterile	Qty. Per Bag	Qty. Per Case
FCF000001	CA	0.45	150/50	Y	1	24
FCF000002		0.22	150/50	Y	1	24
FCF000003	PES	0.45	150/50	Y	1	24
FCF000004		0.22	150/50	Y	1	24
FCF000005	MCE	0.45	150/50	Y	1	24
FCF000006		0.22	150/50	Y	1	24
FCF000007	PVDF	0.45	150/50	Y	1	24
FCF000008		0.22	150/50	Y	1	24
FCF000009	NYLON	0.45	150/50	Y	1	24
FCF000010		0.22	150/50	Y	1	24

JetSpin® Centrifugal Filters

The JetSpin® Centrifugal Filters have been newly upgraded! The filter membranes are made from premium polyethersulfone (PES), offering low protein adsorption, rapid filtration speed, and high recovery rates. Their single/double-sided vertical filter structure and support rib design provide a larger filtration area, reduced dead volume, and enhanced structural stability, allowing for higher centrifugal force compatibility while minimizing process losses.

- ⊙ Inner Filter Specification: 0.5 mL 5 mL 15 mL
- ⊙ Centrifuge Tube Specification: 2 mL 15 mL 50 mL
- ⊙ Molecular weight cutoff (MWCO): 3kDa 5kDa 10kDa 30kDa 50kDa 100kDa
- ⊙ Materials: Centrifuge tube: Polypropylene (PP), Tube cap: High-density polyethylene (HDPE), Filter: Methacrylate-butadiene-styrene (MBS), Filter membrane: Polyethersulfone (PES)

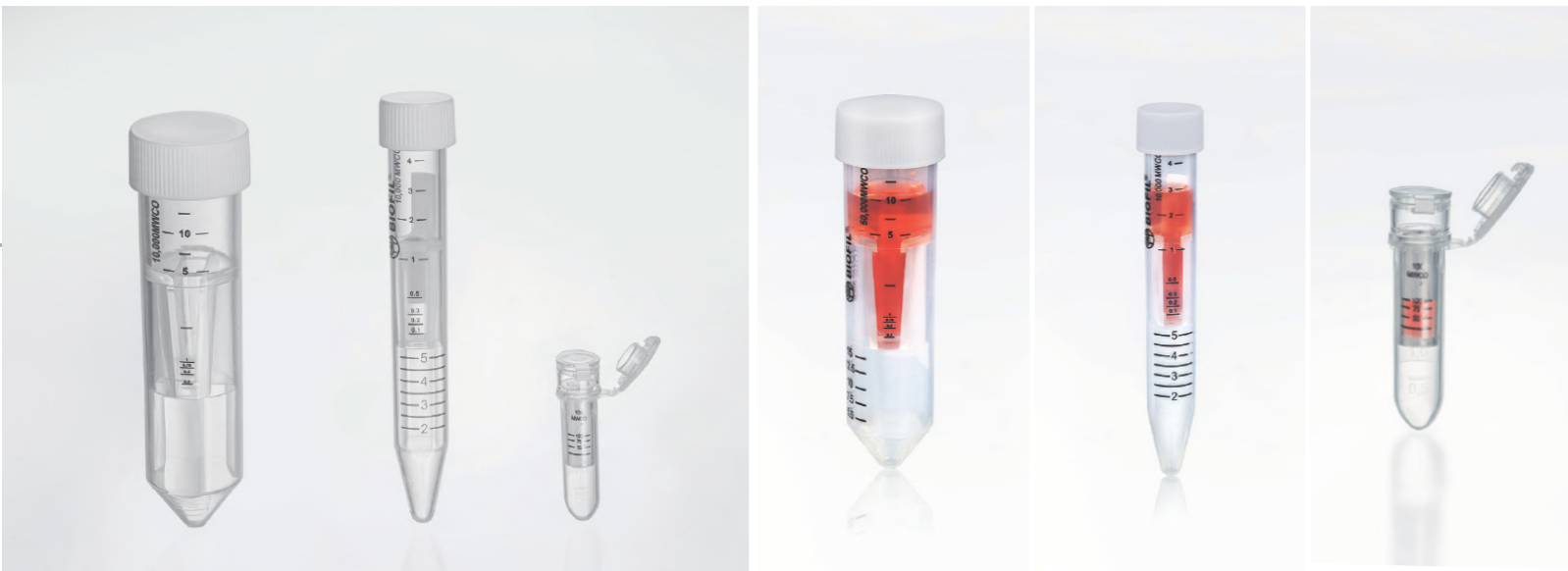

Features

- ⊙ Single (0.5 mL) /Double-sided (5 mL, 15 mL) vertical filter structure provides an effective filtration area of up to 9.7 cm²
- ⊙ Both 15 mL and 50 mL centrifuge tubes feature support ribs that are tightly integrated with membranes, facilitating enhanced structural stability and preventing membrane clogging or rupture under excessive centrifugal force
- ⊙ Rapidly concentrates samples in 5–25 minutes, achieving a concentration factor exceeding 100-fold
- ⊙ Minimal void volume, reduces sample loss during centrifugation
- ⊙ Over 85% of protein recovery rate with excellent repeatability
- ⊙ Precise black graduations on the tube body with clear MWCO indicators, and writing area for easy marking
- ⊙ Membranes are secured into the filter shell using heat-pressing processes, without chemical leaching from adhesives that could contaminate samples and impact analysis results

		JetSpin® 0.5 mL	JetSpin® 5 mL	JetSpin® 15 mL
Sample Volume				
Maximum Initial Sample Volume (mL)	Swinging Bucket Rotor	-	5	15
	Fixed Angle Rotor	0.5	4	12
Final Concentrated Volume (µL)		20-50	40-100	200
Void Volume (µL)		10	35	100
Concentration Factor		10-25	50-125	75
Dimensions				
Effective Filtration Area (cm ²)		0.65	3.5	9.7
Centrifuge Tube (with cap) (mm)	Length	48.1	123.4	119.5
	Diameter	12.9	22	33.7
Filter (mm)	Length	30	68	72.5
	Diameter	12.6	17.1	29.3
Recommended RCF				
Fixed Rotor Angle (°)		40	25	25
Maximum RCF (×g)	Swinging Bucket Rotor	-	4,000	4,000
	Fixed Angle Rotor	10,000	5,000	5,000

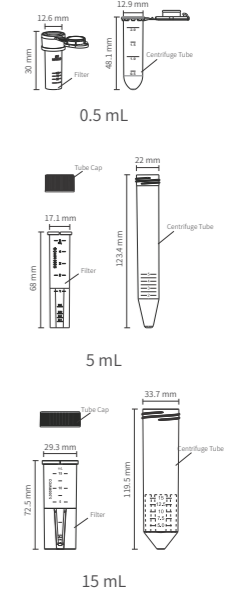

Cat. No.	Inner Filter Specification (mL)	Tube Specification (mL)	Effective Filtration Area (cm ²)	Maximum Initial Sample Volume	Sterile	MWCO (KDa)	Maximum RCF (Fixed Angle Rotor) ×g	Maximum RCF (Swinging Bucket Rotor) ×g	Qty. Per Box	Qty. Per Case
FTT103105	0.5	2	0.65	0.5 mL for fixed angle rotor	N	3	10,000	-	25	300
FTT105105	0.5	2	0.65		N	5	10,000	-	25	300
FTT110105	0.5	2	0.65		N	10	10,000	-	25	300
FTT130105	0.5	2	0.65		N	30	10,000	-	25	300
FTT150105	0.5	2	0.65		N	50	10,000	-	25	300
FTT100105	0.5	2	0.65		N	100	10,000	-	25	300
FTT103150	5	15	3.5	4 mL for fixed angle rotor 5 mL for swinging bucket rotor	N	3	5,000	4,000	24	96
FTT105150	5	15	3.5		N	5	5,000	4,000	24	96
FTT110150	5	15	3.5		N	10	5,000	4,000	24	96
FTT130150	5	15	3.5		N	30	5,000	4,000	24	96
FTT150150	5	15	3.5		N	50	5,000	4,000	24	96
FTT100150	5	15	3.5		N	100	5,000	4,000	24	96
FTT403500	15	50	9.7	12 mL for fixed angle rotor 15 mL for swinging bucket rotor	N	3	5,000	4,000	8	96
FTT503500	15	50	9.7		N	3	5,000	4,000	24	96
FTT405500	15	50	9.7		N	5	5,000	4,000	8	96
FTT505500	15	50	9.7		N	5	5,000	4,000	24	96
FTT410500	15	50	9.7		N	10	5,000	4,000	8	96
FTT510500	15	50	9.7		N	10	5,000	4,000	24	96
FTT430500	15	50	9.7		N	30	5,000	4,000	8	96
FTT530500	15	50	9.7		N	30	5,000	4,000	24	96
FTT450500	15	50	9.7		N	50	5,000	4,000	8	96
FTT550500	15	50	9.7		N	50	5,000	4,000	24	96
FTT400500	15	50	9.7		N	100	5,000	4,000	8	96
FTT500500	15	50	9.7		N	100	5,000	4,000	24	96



— Stock Code: 688026 —

Molecular Biology



Molecular test is a laboratory test that is used to study constituent cells and body fluids using DNA and/or RNA detection technology to identify the molecular characteristics and abnormalities under the basic principle of PCR. Molecular tests are widely used in various fields, such as laboratories, and clinical and non-clinical fields. Molecular diagnosis, an example of the application of molecular tests for in vitro diagnosis, has currently become the fastest-growing and cutting-edge technology in the field of in vitro diagnosis. In addition to disease diagnosis, scientific research institutes, pharmaceutical companies, and CROs also use molecular test technologies and products to carry out research and development. With the development of computer technology and the advancement of precision instrument manufacturing technology, automation technology is increasingly used in molecular tests, resulting in a demand for a series of consumables supporting automation applications, including robotic tips, deep-well plates, PCR plates, etc.

Consumables for molecular tests produced by JET BIOFIL are DNase/RNase and pyrogen-free and produced in a Class 100,000 clean room with high-quality raw materials conforming to USP Class VI standards. The robotic tips have a variety of specifications, allowing them to be compatible with various automatic instruments such as those by Tecan®, Hamilton®, and Beckman®. The deep-well plates also have multiple specifications and sizes conforming to SBS standards, allowing them to be used in the corresponding automatic workstations. The PCR plates are made of high-quality polypropylene (PP) with plate types conforming to SBS, which makes them adaptive to repeated high and low-temperature settings during PCR. Moreover, the PCR plates are suitable for different PCR amplifiers from different manufacturers because of the multiple types available, including non-skirted, semi-skirted and full-skirted plates.

Pipette Micro Tips

Pipette micro tips are used to accurately transfer a small amount of liquid together with a pipette. JET BIOFIL pipette tips can be used with pipettes of most popular brands and are made of polypropylene in line with USP Class VI standards in a 100,000 grade clean room. The high material transparency ensures liquid handling accuracy. They are widely used in liquid pipetting, dispensing and mixing, and in preparing samples for assays and tests.

- Specifications: 10 µL 20 µL 100 µL 200 µL 300 µL 1,000 µL 1,250 µL
- Packaging: Re-sealable Bag Rack Box Reloading Box
- Color: Natural Yellow Blue
- Available configuration: With filter element Without filter element
Materials: Polypropylene (PP), Filter element: Polyolefin (PO), conforming to USP Class VI standards



Features

- Extended tips can reach the bottom of deep containers with narrow mouths without touching the inner walls of the container, thus reducing the risk of contamination
- Suitable for most brands of micropipettes, such as Gilson, Eppendorf, etc.
- Fine graduation facilitates direct visual observation of pipetting volumes
- Sterilized and non-sterilized available, sterilized by irradiation to SAL 10⁻⁶
- DNase/RNase-free, non-pyrogenic

Pipette Micro Tips, 0.1-10 µL

10µL	Cat. No.	Capacity (µL)	Color	Filter	Sterile	Package	Qty./Bag	Qty./Case
	PPT000110	0.1-10	Natural	N	N	Re-sealable bag	1000	10000
	PPT221010	0.1-10	Natural	N	Y	Re-sealable bag	1000	10000
	PPT100010	0.1-10	Natural	Y	N	Re-sealable bag	1000	10000
	PPT101010	0.1-10	Natural	Y	Y	Re-sealable bag	1000	10000
	PPT050010	0.1-10	Natural	N	N	Rack Box	96	1920
	PPT051110	0.1-10	Natural	N	Y	Rack Box	96	1920
	PPT150010	0.1-10	Natural	Y	N	Rack Box	96	1920
	PPT151010	0.1-10	Natural	Y	Y	Rack Box	96	1920

Pipette Micro Tips, 0.1-10 µL, Long Tips

10µL, Long Tips	Cat. No.	Capacity (µL)	Color	Filter	Sterile	Package	Qty./Bag	Qty./Case
	PPT300010	0.1-10	Natural	N	N	Re-sealable bag	1000	10000
	PPT301010	0.1-10	Natural	N	Y	Re-sealable bag	1000	10000
	PPT402010	0.1-10	Natural	Y	N	Re-sealable bag	1000	10000
	PPT401010	0.1-10	Natural	Y	Y	Re-sealable bag	1000	10000
	PPT350010	0.1-10	Natural	N	N	Rack Box	96	1920
	PPT351010	0.1-10	Natural	N	Y	Rack Box	96	1920
	PPT450010	0.1-10	Natural	Y	N	Rack Box	96	1920
	PPT451010	0.1-10	Natural	Y	Y	Rack Box	96	1920

Pipette Micro Tips, 0.5-20 µL

20µL(45mm)	Cat. No.	Capacity (µL)	Color	Filter	Sterile	Package	Qty./Bag	Qty./Case
	PPT520020	0.5-20	Natural	Y	N	Re-sealable bag	1000	10000
	PPT521020	0.5-20	Natural	Y	Y	Re-sealable bag	1000	10000
	PPT510020	0.5-20	Natural	Y	N	Rack Box	96	1920
	PPT511020	0.5-20	Natural	Y	Y	Rack Box	96	1920
	PPT530020	0.5-20	Natural	N	N	Re-sealable bag	1000	10000
	PPT531020	0.5-20	Natural	N	Y	Re-sealable bag	1000	10000
	PPT500020	0.5-20	Natural	N	N	Rack Box	96	1920
	PPT501020	0.5-20	Natural	N	Y	Rack Box	96	1920

Pipette Micro Tips, 2-20 µL

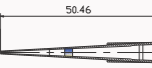
20µL(51mm)	Cat. No.	Capacity (µL)	Color	Filter	Sterile	Package	Qty./Bag	Qty./Case
	PPT100020	2-20	Natural	Y	N	Re-sealable bag	1000	10000
	PPT101020	2-20	Natural	Y	Y	Re-sealable bag	1000	10000
	PPT150020	2-20	Natural	Y	N	Rack Box	96	1920
	PPT151020	2-20	Natural	Y	Y	Rack Box	96	1920

Pipette Micro Tips, 10-100 µL

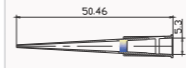
100µL	Cat. No.	Capacity (µL)	Color	Filter	Sterile	Package	Qty./Bag	Qty./Case
	PPT100100	10-100	Natural	Y	N	Re-sealable bag	1000	10000
	PPT101100	10-100	Natural	Y	Y	Re-sealable bag	1000	10000
	PPT150100	10-100	Natural	Y	N	Rack Box	96	1920
	PPT151100	10-100	Natural	Y	Y	Rack Box	96	1920

Pipette Micro Tips, 10-200 µL

200µL	Cat. No.	Capacity (µL)	Color	Filter	Sterile	Package	Qty./Bag	Qty./Case
	PPT000200	10-200	Natural	N	N	Re-sealable bag	1000	10000
	PPT000200-1	10-200	Yellow	N	N	Re-sealable bag	1000	10000
	PPT001200	10-200	Natural	N	Y	Re-sealable bag	1000	10000
	PPT001200-1	10-200	Yellow	N	Y	Re-sealable bag	1000	10000
	PPT150200	10-200	Natural	Y	N	Re-sealable bag	1000	10000
	PPT050200	10-200	Natural	N	N	Rack Box	1000	10000
	PPT051200	10-200	Natural	N	Y	Rack Box	96	1920
	PPT153200	10-200	Natural	Y	Y	Rack Box	96	1920
	PPT151200	10-200	Natural	Y	Y	Re-sealable bag	1000	10000
	PPT152200	10-200	Natural	Y	N	Rack Box	96	1920

Pipette Micro Tips, 10-300 µL

300µL	Cat. No.	Capacity (µL)	Color	Filter	Sterile	Package	Qty./Bag	Qty./Case
	PPT300300	10-300	Natural	N	N	Re-sealable bag	1000	10000
	PPT301300	10-300	Natural	N	Y	Re-sealable bag	1000	10000
	PPT401300	10-300	Natural	Y	Y	Re-sealable bag	1000	10000
	PPT402300	10-300	Natural	Y	N	Re-sealable bag	1000	10000
	PPT350300	10-300	Natural	N	N	Rack Box	96	1920
	PPT351300	10-300	Natural	N	Y	Rack Box	96	1920
	PPT450300	10-300	Natural	Y	N	Rack Box	96	1920
	PPT451300	10-300	Natural	Y	Y	Rack Box	96	1920

Pipette Micro Tips, 100-1000 µL

1000µL	Cat. No.	Capacity (µL)	Color	Filter	Sterile	Package	Qty./Bag	Qty./Case
	PPT000000	100-1000	Natural	N	N	Re-sealable bag	1000	10000
	PPT000000-1	100-1000	Blue	N	N	Re-sealable bag	1000	10000
	PPT001000	100-1000	Natural	N	Y	Re-sealable bag	1000	10000
	PPT001000-1	100-1000	Blue	N	Y	Re-sealable bag	1000	10000
	PPT100000	100-1000	Natural	Y	N	Re-sealable bag	1000	10000
	PPT101000	100-1000	Natural	Y	Y	Re-sealable bag	1000	10000
	PPT050000	100-1000	Natural	N	N	Rack Box	96	1920
	PPT051000	100-1000	Natural	N	Y	Rack Box	96	1920
	PPT150000	100-1000	Natural	Y	N	Rack Box	96	1920
	PPT151000	100-1000	Natural	Y	Y	Rack Box	96	1920

Pipette Micro Tips, 100-1000 µL, Long Tips

1000µL, Long	Cat. No.	Capacity (µL)	Color	Filter	Sterile	Package	Qty. Per Bag	Qty. Per Case
	PPT070000	100-1000	Natural	N	N	Re-sealable bag	1000	10000
	PPT070000-1	100-1000	Blue	N	N	Re-sealable bag	1000	10000
	PPT071000	100-1000	Natural	N	Y	Re-sealable bag	1000	10000
	PPT071000-1	100-1000	Blue	N	Y	Re-sealable bag	1000	10000
	PPT170000	100-1000	Natural	Y	N	Re-sealable bag	1000	10000
	PPT171000	100-1000	Natural	Y	Y	Re-sealable bag	1000	10000
	PPT270000	100-1000	Natural	N	N	Rack Box	96	1920
	PPT271000	100-1000	Natural	N	Y	Rack Box	96	1920
	PPT370000	100-1000	Natural	Y	N	Rack Box	96	1920
	PPT371000	100-1000	Natural	Y	Y	Rack Box	96	1920

Pipette Micro Tips, 100-1250 µL

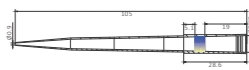
1250µL	Cat. No.	Capacity (µL)	Color	Filter	Sterile	Package	Qty. Per Box	Qty. Per Case
	PPT371250	100-1250	Natural	Y	Y	Rack Box	96	1920

Pipette Micro Tips, 96 Per Bag

96 Per Bag	Cat. No.	Capacity (µL)	Color	Filter	Sterile	Package	Qty. Per Bag	Qty. Per Case
	PPT611010	0.1-10	Natural	N	Y	Re-sealable bag	96	1920
	PPT631010	0.1-10	Natural	N	Y	Re-sealable bag	96	1920
	PPT601200	10-200	Natural	N	Y	Re-sealable bag	96	1920
	PPT601200-1	10-200	Yellow	N	Y	Re-sealable bag	96	1920
	PPT631300	10-300	Natural	N	Y	Re-sealable bag	96	1920
	PPT601000	100-1000	Natural	N	Y	Re-sealable bag	96	1920
	PPT601000-1	100-1000	Blue	N	Y	Re-sealable bag	96	1920
	PPT701010	0.1-10	Natural	Y	Y	Re-sealable bag	96	1920
	PPT703010	0.1-10	Natural	Y	Y	Re-sealable bag	96	1920
	PPT701020	2-20	Natural	Y	Y	Re-sealable bag	96	1920
	PPT701100	10-100	Natural	Y	Y	Re-sealable bag	96	1920
	PPT701200	10-200	Natural	Y	Y	Re-sealable bag	96	1920
	PPT701300	10-300	Natural	Y	Y	Re-sealable bag	96	1920
	PPT701000	100-1000	Natural	Y	Y	Re-sealable bag	96	1920

Pipette Micro Tips, Reloading Box

Reloading Rack	Cat. No.	Capacity (µL)	Color	Filter	LayerQty.	Sterile	Package	Qty. Per Box	Qty. Per Case
	PPT900010	0.1-10	Natural	N	10	N	Reloading Box	960	9600
	PPT900200	10-200	Natural	N	10	N	Reloading Box	960	9600
	PPT901200	10-200	Yellow	N	10	N	Reloading Box	960	9600
	PPT900300	10-300	Natural	N	10	N	Reloading Box	960	9600
	PPT900000	100-1000	Natural	N	5	N	Reloading Box	480	4800
	PPT901000	100-1000	Blue	N	5	N	Reloading Box	480	4800

ZEROTIP® Pipette Micro Tips

The tips are designed with a superhydrophobic surface so as to reduce liquid adsorption, improve accuracy and precision, and reduce reagent loss. They are therefore particularly suited to cell culture experiments, genomics, enzyme reactions, nucleic acid extraction and purification, proteomics, and protein extraction and purification.

- ◎ Specification: 10 µL 20 µL 100 µL 200 µL 300 µL 1,000 µL 1,250 µL
- ◎ Available configuration: With filter element Without filter element
- ◎ Packaging: Re-sealable bag Rack box Reloading box
- ◎ Color: Natural Blue Yellow
- ◎ Materials: Polypropylene (PP), Filter element: Polyolefin (PO), conforming to USP Class VI standards

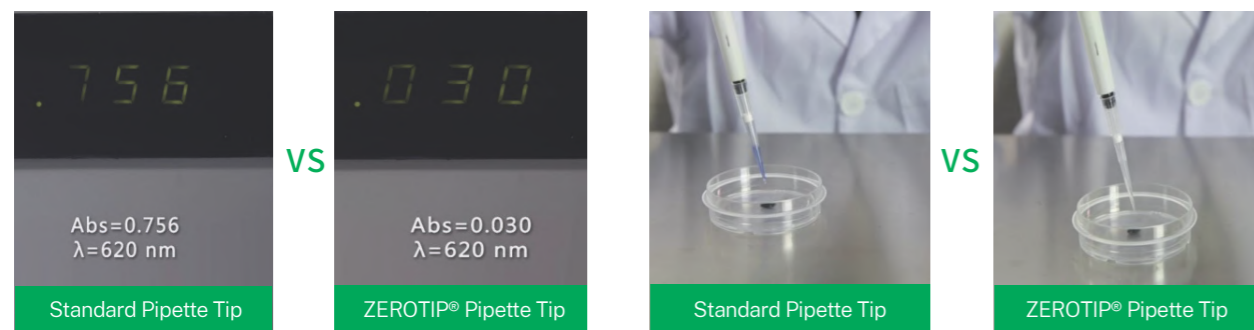
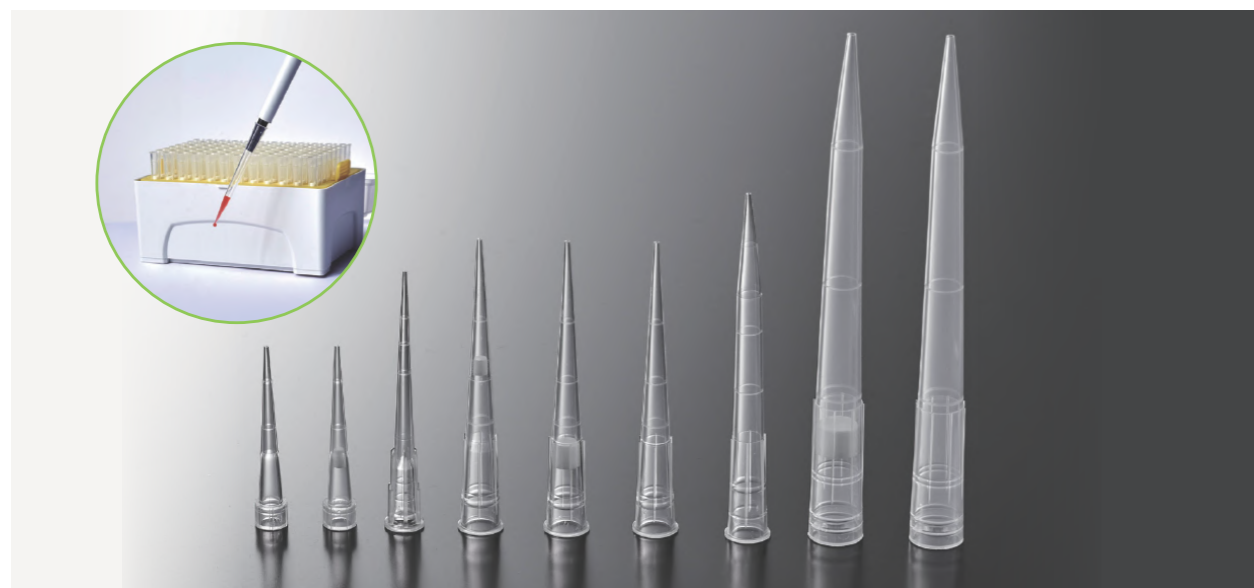

Features

- ◎ Smooth superhydrophobic surface reduces sample loss and improves accuracy and precision
- ◎ Minimizes foam formation during pipetting
- ◎ Suitable for operations involving biological samples, such as detergents and solvents, including SDS, Tween and Triton X-100.
- ◎ Extremely high reproducibility in PCR and real-time PCR applications
- ◎ Uniform superhydrophobic inner surface, non-silanized, free of nucleic acids and PCR inhibitors, effectively reducing sample loss
- ◎ Compatible with most micropipettes, such as Gilson, Eppendorf, etc.
- ◎ Sterilized and non-sterilized available, sterilized by irradiation to SAL 10⁻⁶, DNase/RNase-free, non-pyrogenic

ZEROTIP® Pipette Micro Tips, 0.1-10 µL

10µL	Cat. No.	Capacity(µL)	Color	Filter	Sterile	Package	Qty. Per Bag(Box)	Qty. Per Case
	PMT010010	0.1-10	Natural	N	N	Re-sealable bag	1000	10000
	PMT011010	0.1-10	Natural	N	Y	Re-sealable bag	1000	10000
	PMT110010	0.1-10	Natural	Y	N	Re-sealable bag	1000	10000
	PMT111010	0.1-10	Natural	Y	Y	Re-sealable bag	1000	10000
	PMT250010	0.1-10	Natural	N	N	Rack Box	96	1920
	PMT251010	0.1-10	Natural	N	Y	Rack Box	96	1920
	PMT550010	0.1-10	Natural	Y	N	Rack Box	96	1920
	PMT252010	0.1-10	Natural	Y	Y	Rack Box	96	1920

ZEROTIP® Pipette Micro Tips, 0.1-10 µL, Long Tips

10µL, Long Tips	Cat. No.	Capacity(µL)	Color	Filter	Sterile	Package	Qty. Per Bag(Box)	Qty. Per Case
	PMT030010	0.1-10	Natural	N	N	Re-sealable bag	1000	10000
	PMT031010	0.1-10	Natural	N	Y	Re-sealable bag	1000	10000
	PMT130010	0.1-10	Natural	Y	N	Re-sealable bag	1000	10000
	PMT131010	0.1-10	Natural	Y	Y	Re-sealable bag	1000	10000
	PMT230010	0.1-10	Natural	N	N	Rack Box	96	1920
	PMT231010	0.1-10	Natural	N	Y	Rack Box	96	1920
	PMT232010	0.1-10	Natural	Y	N	Rack Box	96	1920
	PMT233010	0.1-10	Natural	Y	Y	Rack Box	96	1920

ZEROTIP® Pipette Micro Tips, 0.5-20 µL

20µL(45mm)	Cat. No.	Capacity(µL)	Color	Filter	Sterile	Package	Qty. Per Bag(Box)	Qty. Per Case
	PMT520020	0.5-20	Natural	Y	N	Re-sealable bag	1000	10000
	PMT521020	0.5-20	Natural	Y	Y	Re-sealable bag	1000	10000
	PMT510020	0.5-20	Natural	Y	N	Rack Box	96	1920
	PMT511020	0.5-20	Natural	Y	Y	Rack Box	96	1920
	PMT530020	0.5-20	Natural	N	N	Re-sealable bag	1000	10000
	PMT531020	0.5-20	Natural	N	Y	Re-sealable bag	1000	10000
	PMT500020	0.5-20	Natural	N	N	Rack Box	96	1920
	PMT501020	0.5-20	Natural	N	Y	Rack Box	96	1920

ZEROTIP® Pipette Micro Tips, 2-20 µL

20µL(51mm)	Cat. No.	Capacity(µL)	Color	Filter	Sterile	Package	Qty. Per Bag(Box)	Qty. Per Case
	PMT110020	2-20	Natural	Y	N	Re-sealable bag	1000	10000
	PMT111020	2-20	Natural	Y	Y	Re-sealable bag	1000	10000
	PMT250020	2-20	Natural	Y	N	Rack Box	96	1920
	PMT252020	2-20	Natural	Y	Y	Rack Box	96	1920

ZEROTIP® Pipette Micro Tips, 10-100 µL

	Cat. No.	Capacity (µL)	Color	Filter	Sterile	Package	Qty. Per Bag(Box)	Qty. Per Case
	PMT110100	10-100	Natural	Y	N	Re-sealable bag	1000	10000
	PMT111100	10-100	Natural	Y	Y	Re-sealable bag	1000	10000
	PMT250100	10-100	Natural	Y	N	Rack Box	96	1920
	PMT252100	10-100	Natural	Y	Y	Rack Box	96	1920

ZEROTIP® Pipette Micro Tips, 10-200 µL

	Cat. No.	Capacity (µL)	Color	Filter	Sterile	Package	Qty. Per Bag(Box)	Qty. Per Case
	PMT010200	10-200	Natural	N	N	Re-sealable bag	1000	10000
	PMT011200	10-200	Natural	N	Y	Re-sealable bag	1000	10000
	PMT012200	10-200	Natural	Y	N	Re-sealable bag	1000	10000
	PMT111200	10-200	Natural	Y	Y	Re-sealable bag	1000	10000
	PMT250200	10-200	Natural	N	N	Rack Box	96	1920
	PMT251200	10-200	Natural	N	Y	Rack Box	96	1920
	PMT230200	10-200	Natural	Y	N	Rack Box	96	1920
PMT231200	10-200	Natural	Y	Y	Rack Box	96	1920	

ZEROTIP® Pipette Micro Tips, 10-300 µL

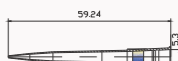
	Cat. No.	Capacity (µL)	Color	Filter	Sterile	Package	Qty. Per Bag(Box)	Qty. Per Case
	PMT030300	10-300	Natural	N	N	Re-sealable bag	1000	10000
	PMT031300	10-300	Natural	N	Y	Re-sealable bag	1000	10000
	PMT130300	10-300	Natural	Y	N	Re-sealable bag	1000	10000
	PMT131300	10-300	Natural	Y	Y	Re-sealable bag	1000	10000
	PMT230300	10-300	Natural	N	N	Rack Box	96	1920
	PMT231300	10-300	Natural	N	Y	Rack Box	96	1920
	PMT232300	10-300	Natural	Y	N	Rack Box	96	1920
	PMT233300	10-300	Natural	Y	Y	Rack Box	96	1920

ZEROTIP® Pipette Micro Tips, 100-1000 µL

	Cat. No.	Capacity (µL)	Color	Filter	Sterile	Package	Qty. Per Bag(Box)	Qty. Per Case
	PMT010000	100-1000	Natural	N	N	Re-sealable bag	1000	10000
	PMT011000	100-1000	Natural	N	Y	Re-sealable bag	1000	10000
	PMT110000	100-1000	Natural	Y	N	Re-sealable bag	1000	10000
	PMT111000	100-1000	Natural	Y	Y	Re-sealable bag	1000	10000
	PMT250000	100-1000	Natural	N	N	Rack Box	96	1920
	PMT251000	100-1000	Natural	N	Y	Rack Box	96	1920
	PMT550000	100-1000	Natural	Y	N	Rack Box	96	1920
	PMT252000	100-1000	Natural	Y	Y	Rack Box	96	1920

ZEROTIP® Pipette Micro Tips, 100-1000 µL Long Tips

	Cat. No.	Capacity (µL)	Color	Filter	Sterile	Package	Qty. Per Bag(Box)	Qty. Per Case
	PMT070000	100-1000	Natural	N	N	Re-sealable bag	1000	10000
	PMT071000	100-1000	Natural	N	Y	Re-sealable bag	1000	10000
	PMT170000	100-1000	Natural	Y	N	Re-sealable bag	1000	10000
	PMT171000	100-1000	Natural	Y	Y	Re-sealable bag	1000	10000
	PMT270000	100-1000	Natural	N	N	Rack Box	96	1920
	PMT271000	100-1000	Natural	N	Y	Rack Box	96	1920
	PMT370000	100-1000	Natural	Y	N	Rack Box	96	1920
	PMT371000	100-1000	Natural	Y	Y	Rack Box	96	1920

ZEROTIP® Pipette Micro Tips, Reloading Box

	Cat. No.	Capacity (µL)	Color	LayerQty.	Filter	Sterile	Package	Qty. Per Bag(Box)	Qty. Per Case
	PMT950010	0.1-10	Natural	10	N	N	Reloading Box	960	9600
	PMT950200	10-200	Natural	10	N	N	Reloading Box	960	9600
	PMT951200	10-200	Yellow	10	N	N	Reloading Box	960	9600
	PMT950300	10-300	Natural	10	N	N	Reloading Box	960	9600
	PMT950000	100-1000	Natural	5	N	N	Reloading Box	480	4800
	PMT951000	100-1000	Blue	5	N	N	Reloading Box	480	4800

Robotic Tips

The robotic tips and non-conductive tips are designed for use in robotic pipetting systems and can be used in various liquid handling workstations, such as those produced by Hamilton Beckman, Tecan and Agilent. They can also be applied to cytomics, genomics, proteomics, immunoassay, metabonomics and the R&D of bio-pharmaceuticals as well as other commonly used high-throughput liquid handling.

- Range of tip capacity: 10 µL-1000 µL
- Available configurations: With filter element
Without filter element
- Color: Natural Black
- Treatment: Non-treated Low Retention Treated
- Materials: Polypropylene (PP), conforming to USP Class VI standards

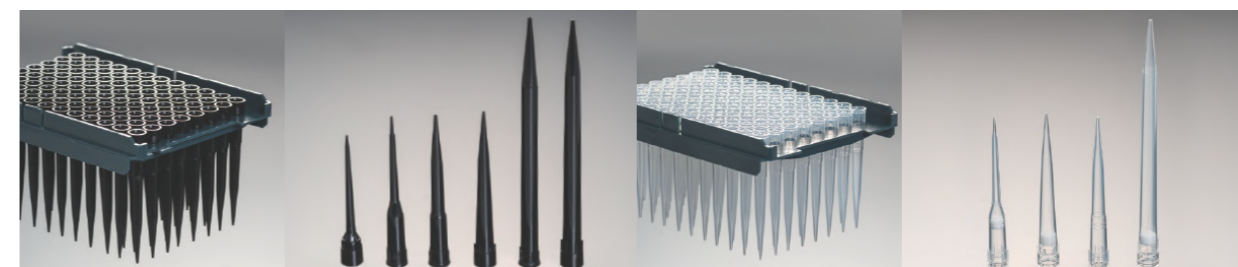

Features

- ⊙ Made of high quality PP for stable performance
- ⊙ Two types available (with and without filter element) to meet different testing requirements
- ⊙ Exclusive technology – smooth inner surface and excellent concentricity of tips, significantly reducing residues
- ⊙ Standard size and excellent air tightness
- ⊙ Highly compatibility for use with a wide range of liquid handling workstations
- ⊙ Sterilized by e-beam and passed SGS verification
- ⊙ Sterilized and non-sterilized available, sterilized by irradiation to SAL 10⁻⁶
- ⊙ DNase/RNase-free, non-pyrogenic

Tecan® Genesis Freedom®, Freedom Evo® and Miniprep with LiHa

Cat. No.	Max Volume (μL)	Surface Type	Sterile	Filter	Color	Package	Qty. Per Box	Qty. Per Case
ATT101010	10	Normal	Y	Y	Natural	Rack Box	96	2304
AMT101010	10	Low Retention	Y	Y	Natural	Rack Box	96	2304
ATT000020	20	Normal	N	N	Natural	Rack Box	96	2304
AMT000020	20	Low Retention	N	N	Natural	Rack Box	96	2304
ATT001020	20	Normal	Y	N	Natural	Rack Box	96	2304
AMT001020	20	Low Retention	Y	N	Natural	Rack Box	96	2304
ATT000050	50	Normal	N	N	Natural	Rack Box	96	2304
AMT000050	50	Low Retention	N	N	Natural	Rack Box	96	2304
ATT001050	50	Normal	Y	N	Natural	Rack Box	96	2304
AMT001050	50	Low Retention	Y	N	Natural	Rack Box	96	2304
ATT101050	50	Normal	Y	Y	Natural	Rack Box	96	2304
AMT101050	50	Low Retention	Y	Y	Natural	Rack Box	96	2304
ATT000200	200	Normal	N	N	Natural	Rack Box	96	2304
AMT000200	200	Low Retention	N	N	Natural	Rack Box	96	2304
ATT001200	200	Normal	Y	N	Natural	Rack Box	96	2304
AMT001200	200	Low Retention	Y	N	Natural	Rack Box	96	2304
ATT101200	200	Normal	Y	Y	Natural	Rack Box	96	2304
AMT101200	200	Low Retention	Y	Y	Natural	Rack Box	96	2304
ATT000000	1000	Normal	N	N	Natural	Rack Box	96	1536
AMT000000	1000	Low Retention	N	N	Natural	Rack Box	96	1536
ATT001000	1000	Normal	Y	N	Natural	Rack Box	96	1536
AMT001000	1000	Low Retention	Y	N	Natural	Rack Box	96	1536
ATT101000	1000	Normal	Y	Y	Natural	Rack Box	96	1536
AMT101000	1000	Low Retention	Y	Y	Natural	Rack Box	96	1536
AUT101010	10	Normal	Y	Y	Black	Rack Box	96	2304
ANT101010	10	Low Retention	Y	Y	Black	Rack Box	96	2304
AUT000020	20	Normal	N	N	Black	Rack Box	96	2304
ANT000020	20	Low Retention	N	N	Black	Rack Box	96	2304

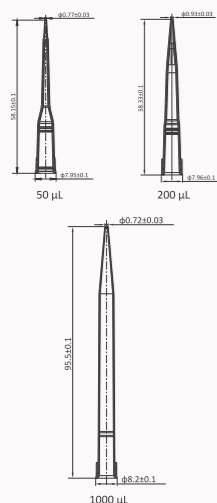

Cat. No.	Max Volume (μL)	Surface Type	Sterile	Filter	Color	Package	Qty. Per Box	Qty. Per Case
AUT001020	20	Normal	Y	N	Black	Rack Box	96	2304
ANT001020	20	Low Retention	Y	N	Black	Rack Box	96	2304
AUT000050	50	Normal	N	N	Black	Rack Box	96	2304
ANT000050	50	Low Retention	N	N	Black	Rack Box	96	2304
AUT001050	50	Normal	Y	N	Black	Rack Box	96	2304
ANT001050	50	Low Retention	Y	N	Black	Rack Box	96	2304
AUT101050	50	Normal	Y	Y	Black	Rack Box	96	2304
ANT101050	50	Low Retention	Y	Y	Black	Rack Box	96	2304
AUT000200	200	Normal	N	N	Black	Rack Box	96	2304
ANT000200	200	Low Retention	N	N	Black	Rack Box	96	2304
AUT001200	200	Normal	Y	N	Black	Rack Box	96	2304
ANT001200	200	Low Retention	Y	N	Black	Rack Box	96	2304
AUT101200	200	Normal	Y	Y	Black	Rack Box	96	2304
ANT101200	200	Low Retention	Y	Y	Black	Rack Box	96	2304
AUT000000	1000	Normal	N	N	Black	Rack Box	96	1536
ANT000000	1000	Low Retention	N	N	Black	Rack Box	96	1536
AUT001000	1000	Normal	Y	N	Black	Rack Box	96	1536
ANT001000	1000	Low Retention	Y	N	Black	Rack Box	96	1536
AUT101000	1000	Normal	Y	Y	Black	Rack Box	96	1536
ANT101000	1000	Low Retention	Y	Y	Black	Rack Box	96	1536

Beckman®, FX/NX, Multimek AP96 and Biomek3000

Cat. No.	Max Volume (μL)	Surface Type	Sterile	Filter	Color	Package	Qty. Per Box	Qty. Per Case
ATB000020	20	Normal	N	N	Natural	Rack Box	96	4800
AMB000020	20	Low Retention	N	N	Natural	Rack Box	96	4800
ATB001020	20	Normal	Y	N	Natural	Rack Box	96	4800
AMB001020	20	Low Retention	Y	N	Natural	Rack Box	96	4800
ATB101020	20	Normal	Y	Y	Natural	Rack Box	96	4800
AMB101020	20	Low Retention	Y	Y	Natural	Rack Box	96	4800
ATB000050	50	Normal	N	N	Natural	Rack Box	96	4800
AMB000050	50	Low Retention	N	N	Natural	Rack Box	96	4800
ATB001050	50	Normal	Y	N	Natural	Rack Box	96	4800
AMB001050	50	Low Retention	Y	N	Natural	Rack Box	96	4800
ATB101050	50	Normal	Y	Y	Natural	Rack Box	96	4800
AMB101050	50	Low Retention	Y	Y	Natural	Rack Box	96	4800
ATB000250	250	Normal	N	N	Natural	Rack Box	96	4800
AMB000250	250	Low Retention	N	N	Natural	Rack Box	96	4800
ATB001250	250	Normal	Y	N	Natural	Rack Box	96	4800

Cat. No.	Max Volume (µL)	Surface Type	Sterile	Filter	Color	Package	Qty. Per Box	Qty. Per Case
AMB001250	250	Low Retention	Y	N	Natural	Rack Box	96	4800
ATB101180	250	Normal	Y	Y	Natural	Rack Box	96	4800
AMB101180	250	Low Retention	Y	Y	Natural	Rack Box	96	4800

BECKMAN®, FX/NX, Multimek AP96 and Biomek3000

Cat. No.	Max Volume (µL)	Surface Type	Sterile	Filter	Color	Package	Qty. Per Box	Qty. Per Case
AUB000020	20	Normal	N	N	Black	Rack Box	96	4800
ANB000020	20	Low Retention	N	N	Black	Rack Box	96	4800
AUB001020	20	Normal	Y	N	Black	Rack Box	96	4800
ANB001020	20	Low Retention	Y	N	Black	Rack Box	96	4800
AUB101020	20	Normal	Y	Y	Black	Rack Box	96	4800
ANB101020	20	Low Retention	Y	Y	Black	Rack Box	96	4800
AUB000050	50	Normal	N	N	Black	Rack Box	96	4800
ANB000050	50	Low Retention	N	N	Black	Rack Box	96	4800
AUB001050	50	Normal	Y	N	Black	Rack Box	96	4800
ANB001050	50	Low Retention	Y	N	Black	Rack Box	96	4800
AUB101050	50	Normal	Y	Y	Black	Rack Box	96	4800
ANB101050	50	Low Retention	Y	Y	Black	Rack Box	96	4800
AUB000250	250	Normal	N	N	Black	Rack Box	96	4800
ANB000250	250	Low Retention	N	N	Black	Rack Box	96	4800
AUB001250	250	Normal	Y	N	Black	Rack Box	96	4800
ANB001250	250	Low Retention	Y	N	Black	Rack Box	96	4800
AUB101180	250	Normal	Y	Y	Black	Rack Box	96	4800
ANB101180	250	Low Retention	Y	Y	Black	Rack Box	96	4800

Hamilton® STAR, STARlet, STARplus and Nimbus®

Cat. No.	Max Volume (µL)	Surface Type	Sterile	Filter	Color	Package	Qty. Per Box	Qty. Per Case
ATH000050	50	Normal	N	N	Natural	Rack Box	96	2304
AMH000050	50	Low Retention	N	N	Natural	Rack Box	96	2304
ATH001050	50	Normal	Y	N	Natural	Rack Box	96	2304
AMH001050	50	Low Retention	Y	N	Natural	Rack Box	96	2304
ATH101050	50	Normal	Y	Y	Natural	Rack Box	96	2304
AMH101050	50	Low Retention	Y	Y	Natural	Rack Box	96	2304
ATH000300	300	Normal	N	N	Natural	Rack Box	96	2304
AMH000300	300	Low Retention	N	N	Natural	Rack Box	96	2304
ATH001300	300	Normal	Y	N	Natural	Rack Box	96	2304
AMH001300	300	Low Retention	Y	N	Natural	Rack Box	96	2304

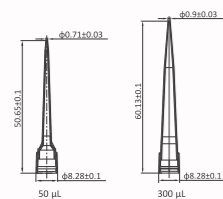

Cat. No.	Max Volume (µL)	Surface Type	Sterile	Filter	Color	Package	Qty. Per Box	Qty. Per Case
ATH101300	300	Normal	Y	Y	Natural	Rack Box	96	2304
AMH101300	300	Low Retention	Y	Y	Natural	Rack Box	96	2304
ATH000000	1000	Normal	N	N	Natural	Rack Box	96	1536
AMH000000	1000	Low Retention	N	N	Natural	Rack Box	96	1536
ATH001000	1000	Normal	Y	N	Natural	Rack Box	96	1536
AMH001000	1000	Low Retention	Y	N	Natural	Rack Box	96	1536
ATH101000	1000	Normal	Y	Y	Natural	Rack Box	96	1536
AMH101000	1000	Low Retention	Y	Y	Natural	Rack Box	96	1536

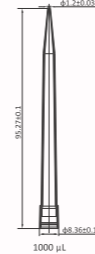

Hamilton® STAR, STARlet, STARplus and Nimbus®

Cat. No.	Max Volume (µL)	Surface Type	Sterile	Filter	Color	Package	Qty. Per Box	Qty. Per Case
AUH000050	50	Normal	N	N	Black	Rack Box	96	2304
ANH000050	50	Low Retention	N	N	Black	Rack Box	96	2304
AUH001050	50	Normal	Y	N	Black	Rack Box	96	2304
ANH001050	50	Low Retention	Y	N	Black	Rack Box	96	2304
AUH101050	50	Normal	Y	Y	Black	Rack Box	96	2304
ANH101050	50	Low Retention	Y	Y	Black	Rack Box	96	2304
AUH000300	300	Normal	N	N	Black	Rack Box	96	2304
ANH000300	300	Low Retention	N	N	Black	Rack Box	96	2304
AUH001300	300	Normal	Y	N	Black	Rack Box	96	2304
ANH001300	300	Low Retention	Y	N	Black	Rack Box	96	2304
AUH101300	300	Normal	Y	Y	Black	Rack Box	96	2304
ANH101300	300	Low Retention	Y	Y	Black	Rack Box	96	2304
AUH000000	1000	Normal	N	N	Black	Rack Box	96	1536
ANH000000	1000	Low Retention	N	N	Black	Rack Box	96	1536
AUH001000	1000	Normal	Y	N	Black	Rack Box	96	1536
ANH001000	1000	Low Retention	Y	N	Black	Rack Box	96	1536
AUH101000	1000	Normal	Y	Y	Black	Rack Box	96	1536
ANH101000	1000	Low Retention	Y	Y	Black	Rack Box	96	1536

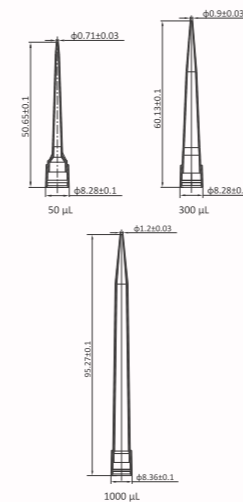

Agilent Robotic Tips

Cat. No.	Max Volume (µL)	Surface Type	Sterile	Filter	Color	Package	Qty. Per Box	Qty. Per Case
ATA000070	0.75-70	Normal	N	N	Natural	Rack Box	384	3840
ATA001070	0.75-70	Normal	Y	N	Natural	Rack Box	384	3840
ATA101050	0.75-70	Normal	Y	Y	Natural	Rack Box	384	3840
AMA000070	0.75-70	Low Retention	N	N	Natural	Rack Box	384	3840
AMA001070	0.75-70	Low Retention	Y	N	Natural	Rack Box	384	3840
AMA101050	0.75-70	Low Retention	Y	Y	Natural	Rack Box	384	3840

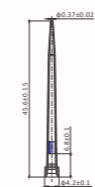

Micro Centrifuge Tubes

Micro centrifuge tubes are mainly used for small amounts of sample storage, transport, and centrifugation, and have wide applications such as molecular biology, clinical chemistry and biochemical research. JET BIOFIL micro centrifuge tubes are made of transparent polypropylene (PP) and are ergonomically designed with a snap flat cap that is easy to open and close, and can be operated with one hand.

- ◎ Specification: 0.5 mL 1.5 mL 2.0 mL 5.0 mL
- ◎ Cap Type: Snap Flat Cap Screw Cap Long-arm Lid without Cap
- ◎ Bottom Type: Conical Self-standing Round
- ◎ Color: Natural Blue Yellow Green Rose Red Black
- ◎ Packaging: Bag (Box)
- ◎ Materials: Polypropylene (PP), conforming to USP Class VI standards



Features

- ◎ 4 capacities available: 0.5 mL, 1.5 mL, 2.0 mL, 5.0 mL, recognized according to different colors on the tube body for convenient operation
- ◎ Conical bottom, smooth and transparent tube body with clear graduation
- ◎ The tube body is designed with a frosted writing area that is convenient for recording
- ◎ The sealing cap can be opened and closed repeatedly, which improves sealing performance, prevent liquid leakage, and is easy to operate with one hand
- ◎ Maximum RCF of up to 25,000 ×g
- ◎ Temperature range: -80°C-121°C (no deformation after high temperature sterilization with the cap open, and remains highly transparency)
- ◎ Sterilized and non-sterilized available, sterilized by irradiation to SAL 10⁻⁶
- ◎ DNase/RNase-free, non-pyrogenic

Micro Centrifuge Tubes(with Snap Flat Cap)

Cat. No.	Capacity (mL)	Bottom Type	Color	Maximum RCF (xg)	Sterile	Qty. Per Bag (Box)	Qty. Per Case
CFT000005	0.5	Conical	Natural	25,000	N	1000	8000
CFT000015	1.5	Conical	Natural	25,000	N	500	4000
CFT000020	2.0	Conical	Natural	25,000	N	500	4000
CFT022050	5.0	Conical	Natural	25,000	N	200	4000
CFT001005	0.5	Conical	Natural	25,000	Y	1000	8000
CFT001015	1.5	Conical	Natural	25,000	Y	500	4000
CFT001020	2.0	Conical	Natural	25,000	Y	500	4000
CFT002050	5.0	Conical	Natural	25,000	Y	200	4000
CFT000050	5.0	Conical	Natural	25,000	N	180	1800
CFT023050	5.0	Conical	Blue	25,000	N	200	4000
CFT024050	5.0	Conical	Yellow	25,000	N	200	4000
CFT025050	5.0	Conical	Green	25,000	N	200	4000
CFT026050	5.0	Conical	Rose Red	25,000	N	200	4000
CFT020050	5.0	Conical	Black	25,000	N	200	4000
CFT010050	5.0	Conical	Yellow	25,000	N	250	2500
CFT001050	5.0	Conical	Natural	25,000	Y	180	1800
CFT013050	5.0	Conical	Natural	25,000	Y	60	1800
CFT003050	5.0	Conical	Blue	25,000	Y	200	4000
CFT004050	5.0	Conical	Yellow	25,000	Y	200	4000
CFT005050	5.0	Conical	Green	25,000	Y	200	4000
CFT006050	5.0	Conical	Rose Red	25,000	Y	200	4000
CFT021050	5.0	Conical	Black	25,000	Y	200	4000
CFT011050	5.0	Conical	Yellow	25,000	Y	250	2500

Micro Centrifuge Tubes (with Screw Cap)

Cat. No.	Capacity (mL)	Color	Bottom Type	Sterile	With Cap	Qty. Per Box (Bag)	Qty. Per Case
CFT002005	0.5	Natural	Conical	N	N	500	5000
CFT003005	0.5	Natural	Conical	Y	Y	500	5000
CFT004005	0.5	Natural	Self-standing	N	N	500	5000
CFT005005	0.5	Natural	Self-standing	Y	Y	500	5000
CFT005015	1.5	Natural	Conical	N	N	500	5000
CFT006015	1.5	Natural	Conical	Y	Y	500	5000
CFT007015	1.5	Natural	Self-standing	N	N	500	5000
CFT008015	1.5	Natural	Self-standing	Y	Y	500	5000
CFT002020	2.0	Natural	Conical	N	N	500	5000
CFT003020	2.0	Natural	Conical	Y	Y	500	5000
CFT004020	2.0	Natural	Self-standing	N	N	500	5000
CFT005020	2.0	Natural	Self-standing	Y	Y	500	5000
CFT511020	2.0	Natural	Self-standing	Y	Y	500	5000
CFT511320	2.0	Blue	Self-standing	Y	Y	500	5000
CFT511420	2.0	Yellow	Self-standing	Y	Y	500	5000

Micro Centrifuge Tubes (with Long-arm Lid)

Cat. No.	Capacity (mL)	Bottom Type	Color	with Cap	Sterile	Packaging	Qty. Per Bag	Qty. Per Case
CFT108015	1.5	Conical	Natural	Y	N	Bag	50	5000
CFT108020	2.0	Conical	Natural	Y	N	Bag	50	5000

Micro Centrifuge Tubes (without Cap)

Cat. No.	Capacity (mL)	Bottom Type	Color	with Cap	Sterile	Packaging	Qty. Per Bag	Qty. Per Case
CFT008020	1.5	Round	Natural	N	N	Bag	1000	5000

Lid Lock Micro Centrifuge Tubes

Made of transparent polymer, polypropylene (PP), the centrifuge tubes are designed with a lid lock to provide better sealability for sample protection, and to avoid accidental opening of the cap and evaporation of samples during long-term storage, ensuring safe operations.

- Specification: 0.5 mL 1.5 mL 2.0 mL 5.0 mL
- Packaging: Bag
- Color: Natural Blue Yellow Green Rose Red Black
- Materials: Polypropylene (PP), conforming to USP Class VI standards



Features

- Multiple volume and color specifications available, easy for recording and identification
- Conical bottom, smooth and transparent tube with a clear scale to facilitate volume reading
- The tube is designed with a frosted area to record experimental data
- Lid lock prevents accidental opening of cap and evaporation of samples during long-term storage, and ensures safe operations
- Maximum RCF of up to 25,000 ×g
- Temperature range: -80°C–121°C (does not deform after high-temperature sterilization and remains highly transparent)
- Sterilized by irradiation, SAL 10⁻⁶
- DNase/RNase-free, non-pyrogenic

Cat. No.	Capacity (mL)	Color	Sterile	Qty. Per Box	Qty. Per Case
CFT010005	0.5	Natural	N	1000	8000
CFT010015	1.5	Natural	N	500	4000
CFT020015	1.5	Brown	N	500	4000
CFT010020	2.0	Natural	N	500	4000
CFT011005	0.5	Natural	Y	1000	8000
CFT011015	1.5	Natural	Y	500	4000
CFT021015	1.5	Brown	Y	500	4000
CFT011020	2.0	Natural	Y	500	4000
CFT030005	0.5	Black	N	1000	8000
CFT030015	1.5	Black	N	500	4000
CFT030020	2.0	Black	N	500	4000
CFT031005	0.5	Black	Y	1000	8000
CFT031015	1.5	Black	Y	500	4000
CFT031020	2.0	Black	Y	500	4000
CFT122050	5.0	Natural	N	200	4000
CFT123050	5.0	Blue	N	200	4000
CFT124050	5.0	Yellow	N	200	4000
CFT125050	5.0	Green	N	200	4000
CFT126050	5.0	Rose Red	N	200	4000
CFT127050	5.0	Black	N	200	4000
CFT110050	5.0	Yellow	N	250	2500
CFT112050	5.0	Black	N	250	2500
CFT322050	5.0	Natural	Y	200	4000
CFT323050	5.0	Blue	Y	200	4000
CFT324050	5.0	Yellow	Y	250	2500
CFT224050	5.0	Yellow	Y	200	4000
CFT325050	5.0	Green	Y	200	4000
CFT326050	5.0	Rose Red	Y	200	4000

Cat. No.	Capacity (mL)	Color	Sterile	Qty. Per Box	Qty. Per Case
CFT327050	5.0	Black	Y	200	4000
CFT210050	5.0	Yellow	Y	250	2500
CFT212050	5.0	Black	Y	250	2500

EasyFlip™ 1.5 mL Micro Centrifuge Tubes

The EasyFlip™ 1.5 mL micro centrifuge tubes are made of high-quality polymer polypropylene (PP). They are suitable for storage, operation and centrifugation of small amounts of samples, and may also be used with micropipettes for storage, operation and centrifugation of small amounts of liquid.

- Specification: 1.5 mL
- Bottom type: Conical
- Packaging: Bag (Box)
- Materials: Polypropylene (PP), conforming to USP Class VI standards



Features

- One-hand easy flip to open the cap
- Frosted body surface provides ease of marking and legibility
- Rigorously tested for leakage, excellent sealing performance
- Maximum RCF up to 25,000 xg
- Temperature range: -80°C-121°C
- Sterilized and non-sterilized available, sterilized by irradiation to SAL 10⁻⁶
- DNase/RNase-free, non-pyrogenic

Cat. No.	Capacity (mL)	Sterile	Qty. Per Box	Qty. Per Case
CFT002015	1.5	N	500	4000
CFT003015	1.5	Y	500	4000

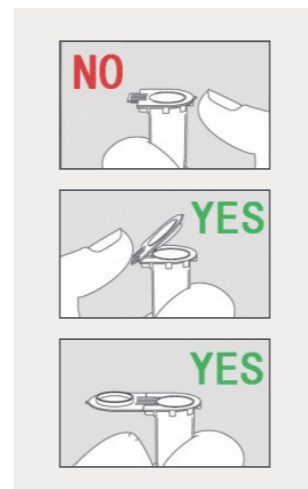

Low Binding Micro centrifuge Tubes

Lo-Protein™ Micro centrifuge Tubes

Lo-DNA™ Micro centrifuge Tubes

Gene therapy and vaccine production often involve various types of purification for proteins, DNA, and other substances. Since nonspecific binding to plastic containers will lead to the loss of valuable samples, the purification processes often depend on high-quality plastic products for sample processing and storage. The smaller the sample volume is, the more important it becomes to reduce the binding between the sample and the container used.

The low binding microcentrifuge tubes of JET BIOFIL are optimized for protein and DNA analytics. These tubes are made using a unique high-purity polypropylene polymer material that does not require any surface coating, such as silicization. Strict quality control is implemented in accordance with ISO9001 and ISO13485. The stable quality ensuring significantly reduces binding between samples and plastic surface, minimizing sample loss and achieving a maximum recovery rate of your precious samples and more accurate analysis results.

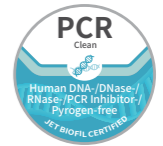

- Material: Polypropylene (PP), conforming to USP Class VI
- Capacity: 0.5 mL 1.5 mL 2.0 mL
- Bottom Type: Conical



Features

- Made of special high-purity polypropylene (PP) polymer can effectively reduce the nonspecific binding of protein/nucleic acid to the tube surface.
- No surface coating (e.g., silicification) on the tube wall can reduce sample binding and interference to samples.
- Lid lock prevents accidental opening of cap and evaporation of samples during long-term storage, and ensures operating safety.
- Smooth and transparent tube body with clear graduation, designed with a frosted writing area, makes it convenient for recording.
- Samples of different proteins and nucleic acids can be ensured to the maximum recovery, with a recovery rate over 90%.
- The product has been tested for 18 items, including tightness, folding resistance of flipped cap, centrifugal force, solvent resistance, extractable and accelerated aging, which shows stable performance.
- The maximum centrifugal force for 1.5 mL, 2 mL is RCF 25,000×g; the maximum centrifugal force for 0.5 mL is RCF 30,000×g.
- Working temperature range: -80°C~121°C (no deformation after autoclaving with open lid)
- Sterilized and non-sterilized available, sterilized by irradiation to SAL 10⁻⁶
- DNase/RNase-free, Non-pyrogenic, human DNA-free, PCR inhibitor-free

Special Tips

1. This product is not recommended for long-term sample storage for samples containing benzene, benzyl alcohol, or chloroform solvents.
2. Re-autoclaving of sterilized low binding microcentrifuge tubes may result in yellowing of the materials but does not affect the usage for the products.
3. The package can be removed and opened for autoclaving sterilization for one time. Repeated autoclaving sterilization is not recommended.

Cat. No.	Low Binding	Capacity (mL)	Maximum RCF (xg)	Sterile	Qty. Per Bag	Qty. Per Case
CFT800005	Protein	0.5	30,000	N	50	400
CFT060005	DNA	0.5	30,000	N	50	1200
CFT800015	Protein	1.5	25,000	N	50	400
CFT060015	DNA	1.5	25,000	N	50	1000
CFT800020	Protein	2.0	25,000	N	50	400
CFT060020	DNA	2.0	25,000	N	50	1000
CFT801005	Protein	0.5	30,000	Y	50	400
CFT061005	DNA	0.5	30,000	Y	50	1200
CFT801015	Protein	1.5	25,000	Y	50	400
CFT061015	DNA	1.5	25,000	Y	50	1000
CFT801020	Protein	2.0	25,000	Y	50	400
CFT061020	DNA	2.0	25,000	Y	50	1000

Deep-well Plates

As a commonly used lab consumable, the deep-well plate is generally used for DNA detection, high-throughput reactions, storage and transfer of samples, and antibody titer detections. It has become popular in recent years as one of the main consumables for nucleic acid testing. Our deep-well plate is made of the polymer polypropylene (PP). Thanks to its broad chemical compatibility, it can be used for a variety of laboratory reagents such as polar organic solutions, as well as acidic and alkaline solutions. Its appearance also conforms to ANSI/SLAS. The product can be used with a variety of automation instruments. In particular, the 96-round-well plates (1 mL) can be used in combination with the magnetic bead kits.

- Number of wells: 48 or 96 wells 384 wells
- Well shape: Round and square types
- Well bottom shape: U-shaped and V-shaped
- Volume: 96-well: 0.36 mL, 0.4 mL, 1.0 mL, 1.6 mL, 2.0 mL and 2.2 mL
48-well: 3.5 mL and 4.6 mL 384-well: 0.12 mL 0.24 mL
- Materials: Polypropylene (PP), conforming to USP Class VI standards

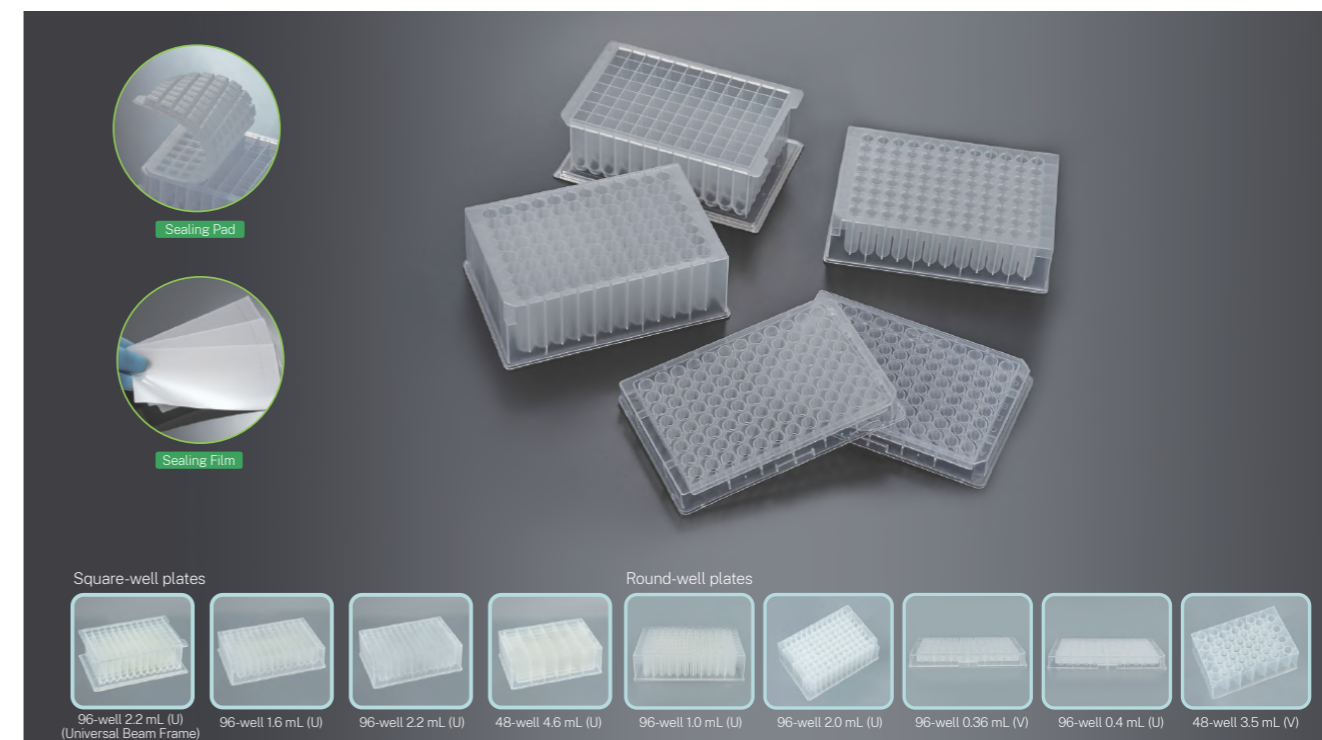

Features

- Stable chemical performance, excellent resistance to chemical corrosion and to high temperatures and pressure
- Even thickness of plate bottom and side walls; smooth plate, no liquid leakage; uniform well diameter
- Alphanumeric markings on the plate and chamfered corners to facilitate identification and operation
- The 96-well deep-well plate can be sealed using either a sealing membrane or a silicone pad
- Maximum RCF 3,000 ×g, with no damage or deformation
- Temperature range: -80°C~121°C
- Sterilized and non-sterilized available, sterilized by irradiation to SAL 10⁻⁶
- DNase/RNase-free, non-pyrogenic

Sample storage

This product can replace the conventional 1.5 mL centrifuge tube for sample storage. It provides outstanding space savings, a large storage volume and a tidy arrangement, and is also suitable for refrigeration down to -80°C, hence it is also called a storage plate.

Sample treatment

Supports high-throughput operation of biological samples by working together with multichannel micropipettes and high-throughput automated liquid handling systems. This includes protein precipitation, liquid dispensing, and nucleic acid extraction, dramatically improving sample treatment efficiency.

Sample handling

Suitable for use with various kinds of automation equipment; can be used for handling samples directly. In comparison to traditional sample handling methods, it increases sample quantity inside the sample chamber by a factor of 2, while also enabling direct sample handling after treatment in the 96-well plate. That reduces the overall workload for back-and-forth sample operations.

96-well Plates

Cat. No.	Capacity (mL)	Qty.well	Bottom	Bottom Shape	Lid	Sterile	Qty. Per Bag (Box)	Qty. Per Case
VWP032096	0.36	96	Round	V Shape	N	N	10	100
VWP033096	0.36	96	Round	V Shape	N	Y	10	100
VWP033196	0.36	96	Round	V Shape	Y	Y	10	100
UWP042096	0.40	96	Round	U Shape	N	N	10	100
UWP043096	0.40	96	Round	U Shape	N	Y	10	100
RWP103296	1.00	96	Round	U Shape	N	Y	5	50
RWP102596	1.00	96	Round	U Shape	Y	N	5	50
RWP103596	1.00	96	Round	U Shape	Y	Y	5	50
RWP203296	2.00	96	Round	U Shape	N	Y	5	50
RWP202596	2.00	96	Round	U Shape	Y	N	5	50
RWP203596	2.00	96	Round	U Shape	Y	Y	5	50
DMP160096	1.60	96	Square	U Shape	N	N	1	50
DMP161096	1.60	96	Square	U Shape	N	Y	1	50
DMP160196	1.60	96	Square	U Shape	Y	N	1	50
DMP161196	1.60	96	Square	U Shape	Y	Y	1	50
DMP220096	2.20	96	Square	U Shape	N	N	1	50
DMP221096	2.20	96	Square	U Shape	N	Y	1	50
DMP220196	2.20	96	Square	U Shape	Y	N	1	50
DMP221196	2.20	96	Square	U Shape	Y	Y	1	50
DMP223296	2.20	96	Square (With UB frame)	U Shape	N	Y	5	50
DMP220296	2.20	96	Square	V Shape	N	Y	1	50
DMP231096	2.20	96	Square	V Shape	N	Y	5	50

Tips Combs (paired with 2.2 mL 96-well plate with V Shape Bottom)

Cat. No.	Description	Bottom Type	Sterile	Qty. Per Bag	Qty. Per Case
MMSK000096	96-well	V Shape	Y	2	100

48-well Plates

Cat. No.	Capacity (mL)	Qty.well	Bottom	Bottom Shape	Lid	Sterile	Qty. Per Bag (Box)	Qty. Per Case
RWP353248	3.50	48	Round	V Shape	N	Y	5	50
RWP352548	3.50	48	Round	V Shape	Y	N	5	50
RWP353548	3.50	48	Round	V Shape	Y	Y	5	50
DMP462048	4.60	48	Square	U Shape	N	N	24	96
DMP463248	4.60	48	Square	U Shape	N	Y	5	50

384-Well Plate

Cat. No.	Capacity (mL)	Qty.well	Bottom	Bottom Shape	Lid	Sterile	Qty. Per Bag (Box)	Qty. Per Case
VWP121384	0.12	384	Square	V Shape	N	Y	20	100
VWP241384	0.24	384	Square	V Shape	N	Y	10	50

Sealing Film

Cat. No.	Description	Specification	Sterile	Qty. Per Bag	Qty. Per Case
DMP010096	For all Deep-well plates	L143×W87×0.4mm	N	50	1000
DMP011096	For all Deep-well plates	L143×W87×0.4mm	Y	100	1000

Sealing Pad

Cat. No.	Description	Sterile	Qty. Per Bag	Qty. Per Case
DMP020096	For all 96-well plates (Square Only)	N	50	100
DMP021096	For all 96-well plates (Square Only)	Y	50	100

Sample Library Tubes

The sample library tubes are disposable consumable products specially designed for long-term storage of samples. They display excellent chemical stability and sealing performance, and are suitable for long-term storage and low-temperature cryopreservation of samples such as serum, cells and tissues.

- Tube Volume: 1.2 mL
- Specifications: single 8-strip tube 12-strip tube
- Materials: Tube body: Polypropylene (PP) Tube Cap: Polyethylene (PE) Tube Rack: Polypropylene (PP) Conforming to USP Class VI standards

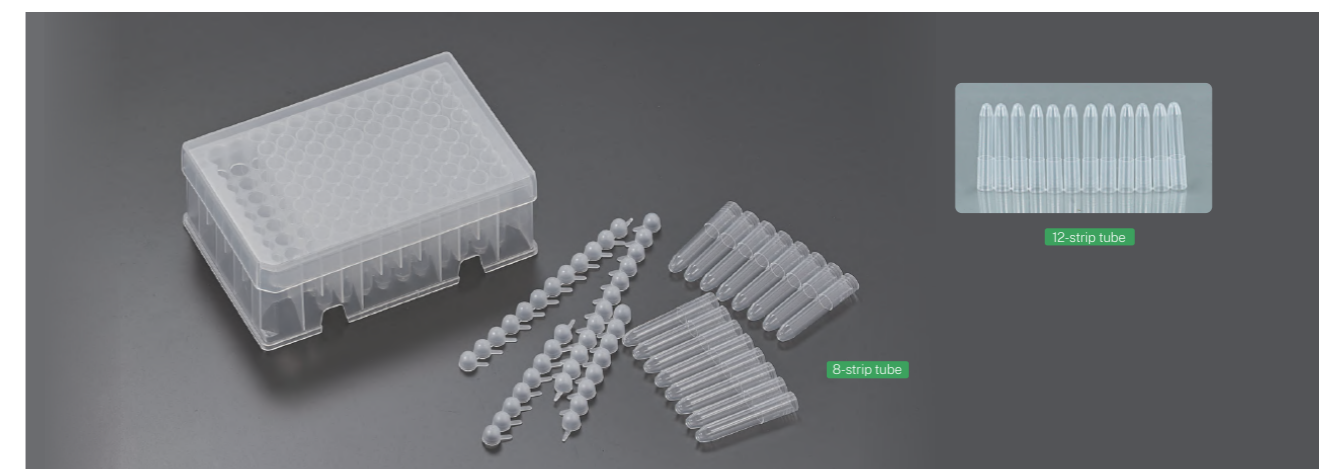

Features

- ◎ The tube body is made of transparent polypropylene with stable chemical properties
- ◎ Uniform wall thickness, smooth and transparent surface, easy to observe and operate
- ◎ Single, 8-strip tube, 12-strip tube and other specifications available with or without cap to meet different experimental needs
- ◎ Clear alphabetical sequence and chamfered corners for easy identification, observation and manipulation of samples during collection and storage
- ◎ Temperature range: -80°C-121°C
- ◎ Sterilized and non-sterilized available sterilized by irradiation to SAL 10⁻⁶
- ◎ DNase/RNase-free, non-pyrogenic

Cat. No.	Capacity (mL)	Sterile	Description	Package	Qty.Per Bag (Rack)	Qty.Per Case
TUC000012	1.2	N	8-strip tube cap	Re-sealable bag	125	1250
TUC000013	1.2	Y	8-strip tube cap	Re-sealable bag	125	1250
TUC000014	1.2	N	12-strip tube cap	Re-sealable bag	80	800
TUC000015	1.2	Y	12-strip tube cap	Re-sealable bag	80	800

Cat. No.	Capacity (mL)	Sterile	Description	Package	Qty.Per Bag (Rack)	Qty.Per Case
TUB000012	1.2	N	8-strip tube	Re-sealable bag	125	1250
TUB001012	1.2	N	12-strip tube	Re-sealable bag	80	800
TUB002012	1.2	N	Individual tube	Re-sealable bag	1000	10000
TUB003012	1.2	N	Individual tube	Rack	960	9600
TUB004012	1.2	Y	Individual tube	Rack	960	9600
TUB005012	1.2	N	8-strip tube	Rack	960	9600
TUB006012	1.2	Y	8-strip tube	Rack	960	9600
TUB007012	1.2	N	12-strip tube	Rack	960	9600
TUB008012	1.2	Y	12-strip tube	Rack	960	9600

Premium PCR Consumables Series

PCR Plates

The PCR plates are the carrier of an amplification reaction system in Polymerase Chain Reaction (PCR) experiments, which is widely used in genetics, biochemistry, immunology, medicine and other fields. The raw materials of the Jet Biofil PCR plates conform to USP Class VI standards. The plate surface is flat, firm and not easy to deform. The thin wall design of the tube body features good thermal conductivity and ensures high-efficiency PCR reaction.

- ◎ Specification: 96-well non-skirted, 96-well semi-skirted, 96-well agree fully skirted
- ◎ Capacity: 0.2 mL/well
- ◎ Color: Transparent White
- ◎ Material: Polypropylene (PP), conforming to USP Class VI standards

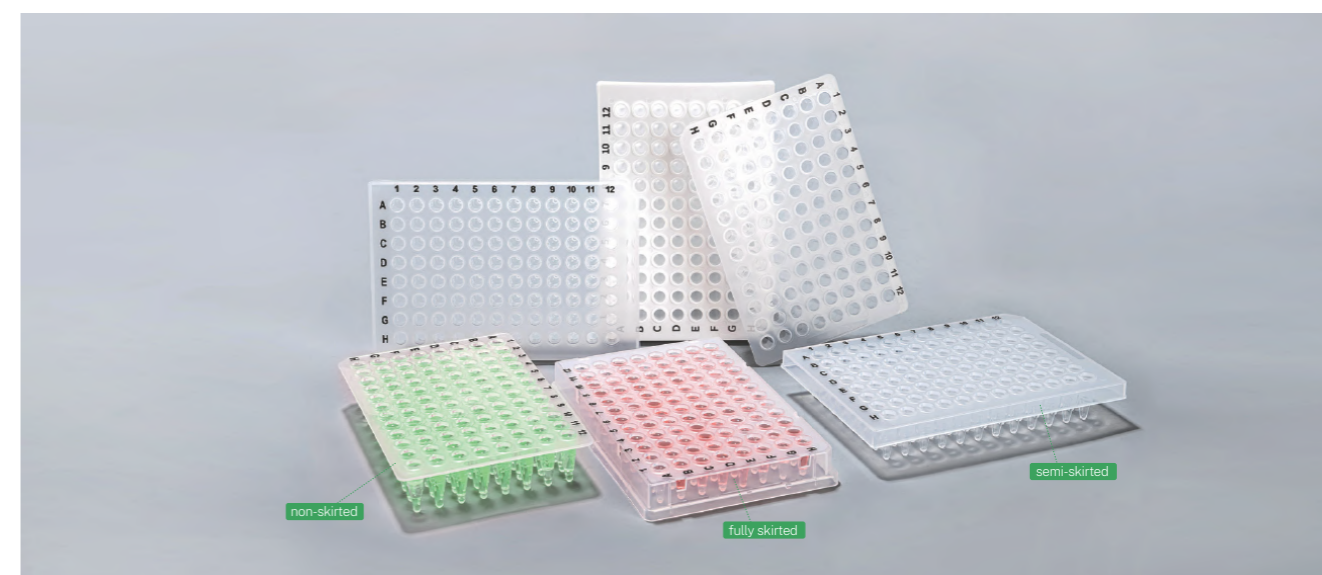

Features

- ◎ Thin tube wall design, uniform thickness, rapid and uniform heat transfer, reliable results and strong repeatability.
- ◎ The plate surface is flat and firm, resistant to warping, and remains reliable and non-deformable in automated, high temperature and high pressure (121°C, 20 min) processes, high-speed centrifugation (2,000×g) and other operations.
- ◎ The edge of the wells protrude to prevent cross-contamination and to facilitate sealing, which can effectively reduce the evaporation of samples after sealing.
- ◎ Black letter markings to help quickly identify and trace samples when manually adding samples.
- ◎ Transparent and white plates are available. The white PCR plate is good for reading low-signal fluorescence values, reduce background fluorescence interference, and are more suitable for qPCR experiments.
- ◎ The plate type conforms to ANSI/SLAS international standards; high adaptability and compatible with many mainstream brands of PCR/qPCR instruments.
- ◎ Each well is strictly tested for leak tightness to ensure safe sample handling
- ◎ Human-derived DNA-free, DNase/RNase-free, non-pyrogenic, PCR inhibitor-free, ATP-free.

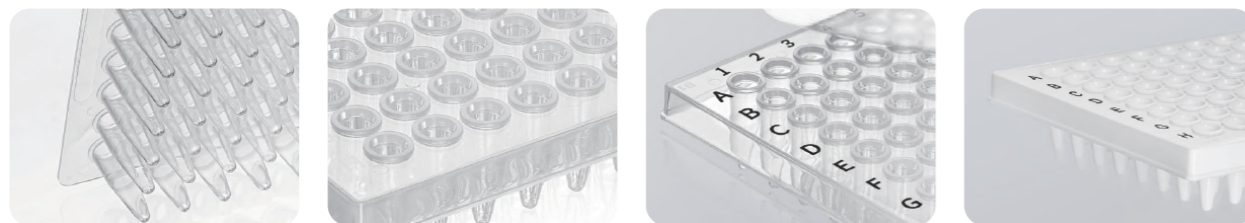
Thin tube wall design,
uniform thicknessThe edge of the wells is
protruding to prevent
cross-contamination and to
facilitate sealing

Black letter marking

White PCR plate

Cat. No.	Capacity (mL)	Specification (Well)	Skirted	Color	Sterile	Qty. Per Box	Qty. Per Case
PCR400096	0.2	96	Non-skirted	Transparent	N	10	100
PCR410096	0.2	96	Semi-skirted	Transparent	N	10	100
PCR420096	0.2	96	Fully skirted	Transparent	N	10	100
PCR401096	0.2	96	Non-skirted	Transparent	Y	10	100
PCR411096	0.2	96	Semi-skirted	Transparent	Y	10	100
PCR421096	0.2	96	Fully skirted	Transparent	Y	10	100
PCR500096	0.2	96	Non-skirted	White	Y	10	100
PCR510096	0.2	96	Semi-skirted	White	Y	10	100
PCR520096	0.2	96	Fully skirted	White	Y	10	100

PCR Tubes

The disposable PCR tubes of JET BIOFIL, with a capacity of 0.2 mL, is made of polypropylene (PP) conforming to USP Class VI standards. When used as the carrier of a PCR amplification system, it can repeatedly withstand high and low temperatures. For low-and medium-throughput PCR/qPCR experiments, the disposable PCR tube is an ideal solution.

- Specification: 8-tube strip, single-tube
- Material: Polypropylene (PP), conforming to USP Class VI standards
- Color: Transparent White



Features

- Thin tube wall design, uniform thickness, rapid and uniform heat transfer, reliable results and strong repeatability.
- Support high-RCF centrifugation (10,000×g), autoclave sterilization (121°C, 20 min) and other operations.
- The tube cap fits perfectly with the body, ensuring a strong sealing performance. This effectively reduces the evaporation rate.
- Different markings at the head and end of the joint cap for easy identification of direction.
- Transparent and white tubes are available. The white PCR tube is good for reading low-signal fluorescence values and reduces background fluorescence interference, and is more suitable for qPCR experiments.
- DNase/RNase-free, human-derived DNA-free, PCR inhibitor-free, ATP-free, non-pyrogenic.

Thin tube wall design,
uniform thicknessThe tube cap is well
matched with the body,
good sealingDifferent marks at the head
and end of the joint cap for
easy identification of direction

White PCR tubes

Cat. No.	Description	Color	Sterile	Qty. Per Bag	Qty. Per Case
PCR410200	0.2mL PCR Tubes with Flat Cap, Single	Transparent	N	1000	10000
PCR420200	0.2mL PCR Tubes with Flat Cap, 8 Strips	Transparent	N	125	1250
PCR411200	0.2mL PCR Tubes with Flat Cap, Single	Transparent	Y	1000	10000
PCR421200	0.2mL PCR Tubes with Flat Cap, 8 Strips	Transparent	Y	125	1250
PCR520200	0.2mL PCR Tubes with Flat Cap, 8 Strips	White	Y	125	1250
PCR620200	0.2mL PCR Tubes with Flat Cap, 8 Strips	Transparent	N	125	1250
PCR621200	0.2mL PCR Tubes with Flat Cap, 8 Strips	Transparent	Y	125	1250

PCR Plate Sealing Films

JET BIOFIL's PCR plate sealing film can be used for routine 96-well PCR experiment, qPCR experiment, sample storage, etc.. Two types of common PCR microplate sealers and qPCR microplate sealers are available.

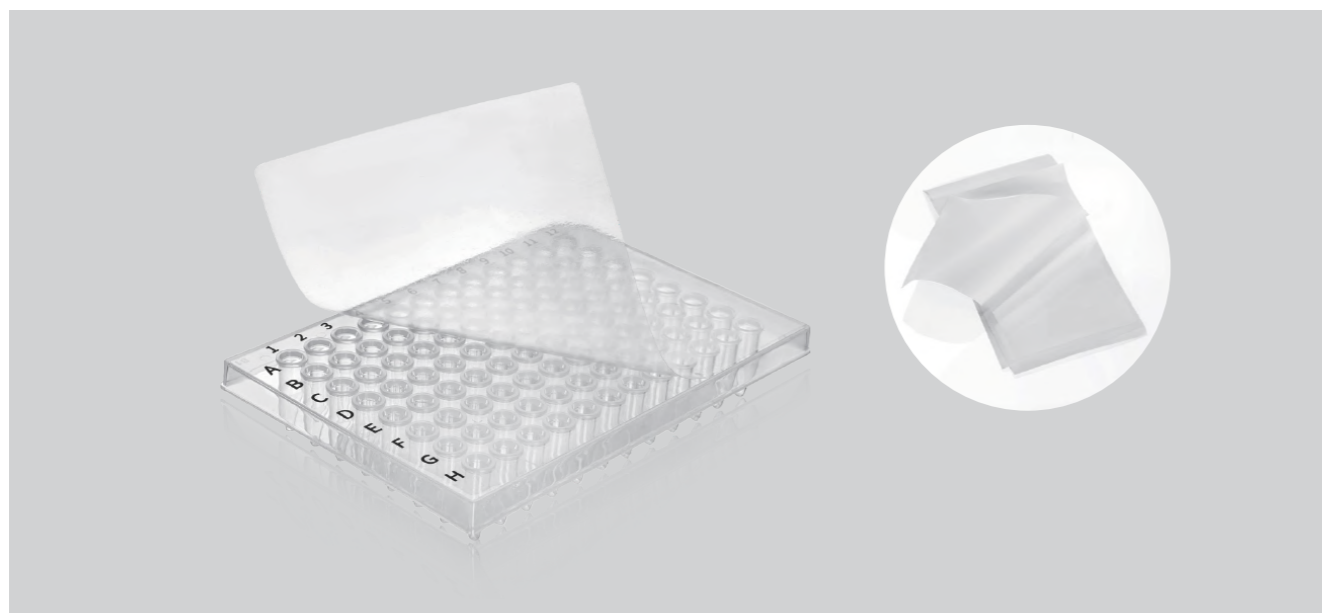

Common PCR Plate Sealing Film:

Material: composed of PP material conforming to USP Class VI standard in the upper layer and medical grade adhesive in the lower layer

Thickness of sealing film: 50 μ m

Temperature tolerance range: -80°C to 121°C

- Economical and easy to use, suitable for mainstream PCR plates
- Good sealing, low evaporation, prevents cross-contamination of samples between wells

qPCR Plate Sealing Film:

Material: The qPCR plate sealing film is composed of a layer of high-transparency PP sealer conforming to USP Class VI standard and medical grade adhesive

Thickness of adhesive sealer: 50 μ m

Temperature tolerance range: -80°C to 121°C

- Innovative adhesives ensure a safe seal without sticking to skin and gloves
- Good sealing, low evaporation, prevents cross-contamination of samples between wells
- No autofluorescence, suitable for fluorescent quantitative PCR

Cat. No.	Type	Specification (length mm * width mm)	Sterile	Qty. Per Box	Qty. Per Case
PCR400001	PCR	137.5*82	N	100	1000
PCR401001	PCR	137.5*82	Y	100	1000
PCR400003	qPCR	140*80	N	100	1000
PCR401003	qPCR	140*80	Y	100	1000

Recommended storage conditions: 10°C-27°C, 40%-60% relative humidity

Plasmid Maxiprep Purification Column

Plasmid Maxiprep Purification Column is primarily used for the extraction and purification of plasmid DNA, widely applied in genetic engineering and molecular biology research. Jet Biofil's Plasmid Purification Column is made from medical-grade, six-layer glass fiber membrane, ensuring stable performance, high binding capacity, and strong impact resistance. It can be used with kits for large-scale plasmid extraction, quickly preparing over 1000 μ g of plasmid DNA. The product is suitable for applications such as enzyme digestion, transformation, PCR amplification, sequencing, and library construction.

- Filter Membrane Layers: 6 layers
- Purification Column Volume: 20 mL
- Centrifuge Tube Volume: 50 mL
- Materials: Filter membrane: Glass fiber, Purification column body and centrifuge tube body: polypropylene (PP), Tube cap: high-density polyethylene (HDPE), O-ring Gasket: Thermoplastic Elastomer (TPE), conforming to USP Class VI standards

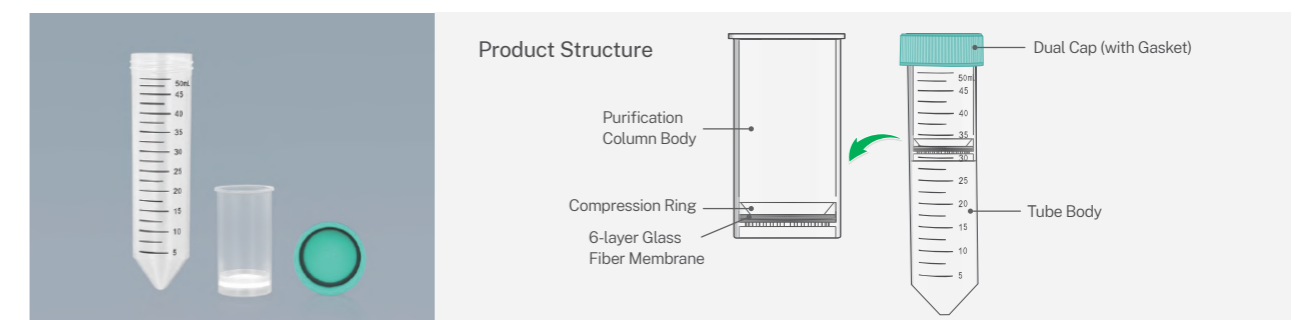

Features

- Injection molded purification column results in a robust structure. The bottom grid, combined with a compression ring, securely holds the filter membrane in place, preventing breakage during centrifugation, and supporting a maximum RCF of 6,000 \times g
- 1 μ m large-pore filter membrane offers strong permeability and prevents column clogging
- Handling up to 20 mL of sample in a single run, quickly yielding more than 1000 μ g of plasmid DNA
- Tube cap design includes an internal O-ring as gasket, ensuring high sealing integrity to prevent sample leakage
- Clear, accurate black graduations with an accuracy of \pm 2%, allowing precise operation for lab personnel
- Extracting high-purity plasmid DNA, with an OD260/OD280 ratio of 1.8-2.0 and an OD260/OD230 ratio greater than 2.0
- Compatible with most standard reagent kits
- DNase/RNase-free, non-pyrogenic

Yield Assessment

Sample	A260/280	A260/230	Concentration(ng/uL)	Yield (μ g)
Sample1	1.9	2.2	484.2	1447
Sample2	1.9	2.1	516.7	1550

Collect 400 mL of overnight bacterial culture (host strain: E. coli, plasmid pET28) and extract the plasmid using the alkaline lysis method with an elution volume of 3000 μ L.

Workflow

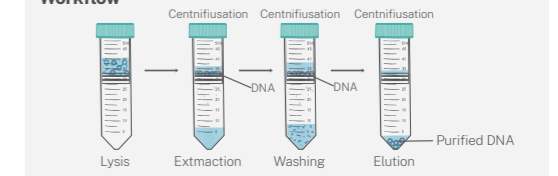

Cat. No.	Description	Tube Volume	Purification column Volume	Membrane Layers	Sterile	Qty./Bag	Qty./Case
NAP006050	Plasmid Maxiprep Purification Column	50 mL	20 mL	6	N	50	200

Shelf Life: 3 years in room temperature

Nucleic Acid Maxiprep Purification Column

The Nucleic Acid Maxiprep Purification Column is specifically designed for the extraction and purification of genomic DNA from various samples. Jet Biofil offers Nucleic Acid Maxiprep Purification Column is made from 4 layers of premium glass fiber membrane, ensuring stability, strong binding capacity, and excellent impact resistance. It enables rapid preparation of genomic DNA yields of up to 4.5 mg, making it suitable for applications such as enzyme digestion, transformation, PCR amplification, sequencing, and library construction.

- Filter Membrane Layers: 4 layers
- Purification Column Volume: 20 mL
- Centrifuge Tube Volume: 50 mL
- Materials: Filter membrane: Glass fiber, Purification column body and centrifuge tube body: polypropylene (PP), Tube cap: high-density polyethylene (HDPE), O-ring Gasket: Thermoplastic Elastomer (TPE), conforming to USP Class VI standards

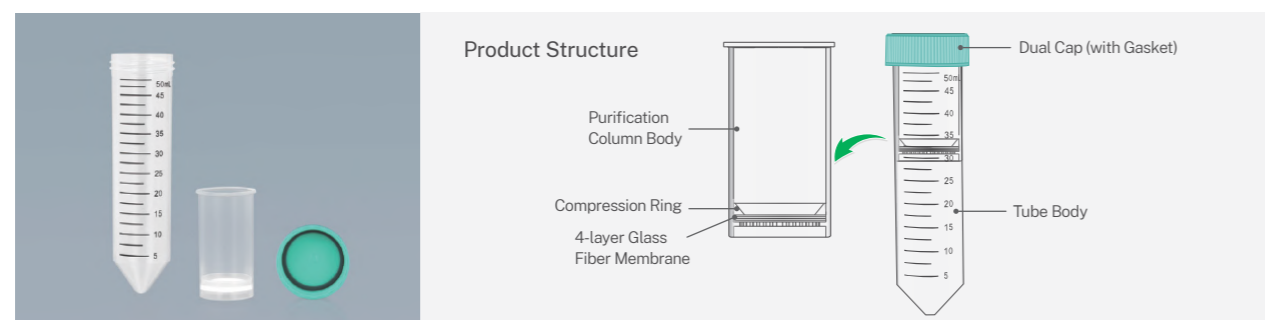

Features

- Injection molded purification column results a robust structure. The bottom grid, combined with a compression ring, securely holds the filter membrane in place, preventing breakage during centrifugation, and supporting a maximum RCF of 6,000 ×g
- Large-pore 1µm filter membrane with high permeability, ensuring no column clogging
- High sample capacity, capable of processing up to 20 mL per run, enabling rapid preparation of over 4.5 mg of genomic DNA
- Tube cap design includes an internal O-ring as gasket, ensuring high sealing integrity to prevent sample leakage
- Clear, accurate black graduations and a large white writing area, making it easy to label during operations
- Extracting high-purity genomic DNA, with an OD260/OD280 ratio of 1.8-2.0 and an OD260/OD230 ratio greater than 2.0
- Compatible with most standard reagent kits
- DNase/RNase-free, non-pyrogenic

Yield Assessment

Category	A260/280	A260/230	Concentration (ng/µL)	Yield (mg)
Binding Capacity	2.0	2.3	2244.3	4.5
	2.0	2.3	2354.6	4.7

Take 5g of pig liver, fully lyse it, and extract genomic DNA. Elute with a volume of 2000 µL and measure the concentration of genomic DNA

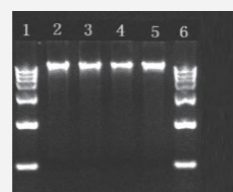

Using the NAP005050 Purification Column, extract genomic DNA from 0.5 g of pig liver. Elute with a volume of 1000 µL, dilute 20 times, and load 5 µL for electrophoresis.

Lane 1: DNA Marker Lanes 4-5: Competitor A
Lanes 2-3: Jet Biofil Lane 6: DNA Marker

Results show that Jet Biofil's Nucleic Acid Maxiprep Purification Column is compatible with commonly used kits for genomic DNA extraction. It delivers high-purity, high-molecular-weight DNA with a binding capacity of over 4.7 mg, achieving performance comparable to leading industry brands.

Cat. No.	Description	Tube Volume	Purification column Volume	Membrane Layers	Sterile	Qty./Bag	Qty./Case
NAP005050	Nucleic Acid Maxiprep Purification Column	50 mL	20 mL	4	N	50	200

Recommended Elution Volume: 1-3 mL Storage: Room temperature Shelf Life: 3 years

Reagent Reservoirs (PP)

The reagent reservoirs are made of transparent polypropylene (PP) for good chemical compatibility. They support both automated and manual operations. A variety of specifications are available, all of which meet the requirements of ANSI/SLAS microplate dimensions, and compatible with most automated systems.

- Specifications: 15 mL 22 mL 185 mL 195 mL
- Material: Polypropylene (PP), conforming to USP Class VI standards



Features

- Multiple capacities and well configurations are available for different experimental needs
- Rhombic well series: 96-or 384-well reagent reservoirs at the bottom, helping to minimize dead space volume
- Multi-channel reagent reservoirs are suitable for both 8-channel and 12-channel pipettes
- Uniform wall thickness and smooth, transparent surface for convenient observation and operation
- Product dimensions conform to ANSI/SLAS standards; highly adaptable and compatible with most of automated systems
- Treated by an electrostatic process and other techniques, no residue or wall clinging, minimizing liquid residue
- Sterilized and non-sterilized available, sterilized by irradiation to SAL 10⁻⁶
- DNase/RNase-free, non-pyrogenic

Cat. No.	Well Capacity (mL)	Total Capacity (mL)	Lid	Number of Wells	Sterile	Qty. Per Box	Qty. Per Case
RES082022	22	-	N	8	N	10	50
RES083022	22	-	N	8	Y	10	50
RES122015	15	-	N	12	N	10	50
RES123015	15	-	N	12	Y	10	50
RES962095	-	195	N	96	N	10	50
RES963095	-	195	N	96	Y	10	50
RES842085	-	185	N	384	N	10	50
RES843085	-	185	N	384	Y	10	50

Reagent Reservoirs (PET / PS)

The Reagent Reservoirs (PET/PS) are mainly used for holding transferred reagents in cases where the same liquid may need to be transferred several times during the process. In particular, when a multi-channel pipettes or liquid-transferring instrument is used, the process becomes easier when liquids are placed in the liquid transfer trough. This trough produced by JET BIOFIL will remain stable and leave fewer residues. Users can easily remove liquids from multi-channel pipettes.

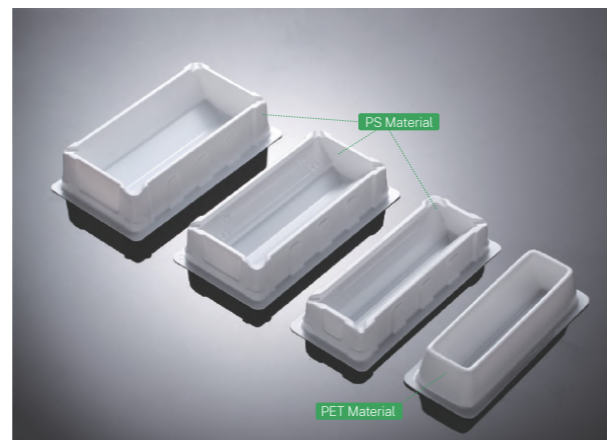

- ◎ Specification: 25 mL 50 mL 100 mL
- ◎ Material: Polyethylene terephthalate(PET)/polystyrene (PS), conforming to USP Class VI standards

Features

- ◎ Made of high-quality PET/PS with excellent chemical stability
- ◎ Available in various specifications; suitable for use with multi-channel pipettes
- ◎ Clean and smooth surfaces
- ◎ Slightly tilted inner surface, which helps to reduce residue
- ◎ Sterilized by irradiation, SAL 10⁻⁶
- ◎ DNase/RNase-free, non-pyrogenic

Cat. No.	Capacity (mL)	Color	Sterile	Material	Qty. Per Bag	Qty. Per Case
LTT012025	25	White	Y	PS	1	50
LTT052025	25		Y	PS	5	100
LTT002025	25		N	PS	100	100
LTT012050	50		Y	PS	1	50
LTT052050	50		Y	PS	5	100
LTT002050	50		N	PS	100	100
LTT000050	50		N	PET	20	400
LTT001050	50		Y	PET	20	400
LTT010050	50		N	PET	1	1/80
LTT011050	50		Y	PET	1	1/80
LTT012100	100		Y	PS	1	1/50
LTT052100	100		Y	PS	5	100
LTT002100	100		N	PS	100	100

12-Channel Reagent Reservoirs

The 12-channel reagent reservoirs are mainly used for pipetting reagents. It is necessary to repeatedly pipette liquids in pipetting, serial dilution, and other operations. Especially when using multi-channel pipettes, it's easier to pipette if the liquid is placed in a reservoir. JET BIOFIL's 12-channel reagent reservoirs honor smooth tabletop stability and little residue, making it convenient for users to realize quick and continuous pipetting operations with multi-channel pipettes.

- ◎ Material: Polypropylene (PP), Conforming to USP Class VI standards



Features

- ◎ Made of high-quality polypropylene raw materials, transparent and visible, with little liquid residue and strong chemical corrosion resistance, suitable for the storage of most polar organic solutions, acidic and alkaline solutions
- ◎ Overall rectangular structure, with widened bottom edge and good stability on table surface
- ◎ 12-channel design, with each channel holding 3 mL, which facilitates continuous dilution or pipetting of different liquids at the same time
- ◎ Each channel is numbered for easy identification
- ◎ The inclined wall and V-shaped bottom design make sample recovery easy
- ◎ Equipped with an upper cover, which closely fits the reservoirs and can effectively reduce evaporation and contamination during incubation and storage
- ◎ Suitable for multi-channel pipettes of most brands
- ◎ Each product has a separate, easy-to-tear PE bag
- ◎ Working temperature range: -80°C ~ 121°C
- ◎ Sterilized and non-sterilized available, sterilized by irradiation to SAL 10⁻⁶
- ◎ DNase/RNase-free, non-pyrogenic

Cat. No.	Capacity(mL)	L×W×H (mm)	Cover	Sterile	Color	Qty. Per Box/ Case
LTT011012	3×12	127.6×57.7×26.4	Y	Y	Transparent	1/50
LTT001012	3×12	127.6×57.7×26.4	Y	N		1/50
LTT012012	3×12	127.6×57.7×26.4	Y	Y		1/240
LTT002012	3×12	127.6×57.7×26.4	Y	N		1/240



— Stock Code: 688026 —

CellSafe™ GMP-grade Life Science Consumables



Biomedicine is booming, and it is urgent to improve the cleanliness grade of consumables

China's biomedical industry has entered a stage of rapid development, including antibodies, vaccines, recombinant proteins, cell therapy, gene therapy, etc. The approval policy for biomedicines has gradually become in line with international standards, and relevant policies, regulations and guiding principles have been rapidly rolled out in recent years. The quality requirements of consumables related to biological products are becoming increasingly stricter, including for functional applicability research, biosafety research and biocompatibility research. Therefore, it is urgent to improve the cleanliness grade of consumables for biological laboratories.

Jet Biofil's GMP-grade Life Science Consumables Higher Cleanliness, Enhanced Biosafety!

By mastering a number of key core technologies and advanced production processes for international leading biological laboratory consumables, JET BIOFIL has been committed to creative solutions to provide higher quality biotechnology research and development tools for more than 20 years. The CellSafe™ series of GMP-grade life science consumables can meet the requirements of biopharmaceutical companies and other clean laboratories for biological experimental consumables of higher cleanliness levels for standard manufacturing and large-scale production of cell therapies, gene therapies, antibodies and vaccines.

CellSafe™ GMP-grade Life Science Consumables

JET BIOFIL is always committed to providing you with higher quality products. The CellSafe™ series GMP-grade bioscience consumables are manufactured in strict accordance with GMP standards, with high cleanliness, high safety, and medical triple bagged packaging, which can meet the needs of biopharmaceutical companies or other clean laboratories for biological laboratory consumables of higher cleanliness levels for cell therapies, gene therapies, antibodies and vaccines.

- ⊙ Products: Serological pipets, centrifuge tubes, conical centrifuge bottles, cell and tissue culture flasks, cell and tissue culture plates, cell and tissue culture dishes, cell factories, Erlenmeyer flasks, etc.
- ⊙ Packaging: Triple-bagged packaging for medical use



Features

- ⊙ ISO 13485 (medical device quality management system) and ISO 9001 certified
- ⊙ Produced in Class 100,000 (partially Class 10,000) GMP cleanrooms with a fully automatic production process
- ⊙ U.S. FDA registered company (registration No.: 3011966385) and obtained the EU CE record
- ⊙ Made with USP Class VI standards medical-grade raw materials
- ⊙ CNAS-accredited laboratory; finished products are authoritatively tested by third-party testing institutions
- ⊙ Independent three-layer medical outer packaging, which can be easily removed layer by layer, and is safe and convenient to use
- ⊙ The smallest bag of each product is marked with the batch number, which is easy for quality traceability
- ⊙ Sterilized by irradiation, SAL 10⁻⁶
- ⊙ DNase/RNase-free, pyrogen-free, non-cytotoxic

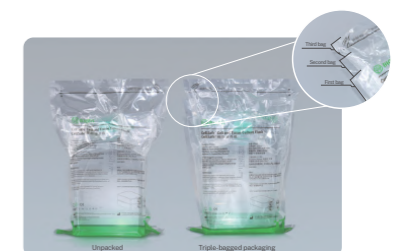

CellSafe™ Serological Pipets

	Cat. No.	Volume (mL)	Scale (mL)	Color code	Packaging	Sterile	Qty. Per Bag	Qty. Per Case
	CSP010005	5	1/10	Blue	Triple-bagged packaging	Y	10	200
	CSP013010	10 (Stretch)	1/10	Orange	Triple-bagged packaging	Y	10	200
	CSP010010	10	1/10	Orange	Triple-bagged packaging	Y	10	200
	CSP010025	25	2/10	Red	Triple-bagged packaging	Y	10	150
	CSP010050	50	5/10	Purple	Triple-bagged packaging	Y	10	100

CellSafe™ Centrifuge Tubes

	Cat. No.	Volume (mL)	Bottom	Maximum RCF (xg)	Packaging	Sterile	Qty. Per Bag	Qty. Per Case
	CSP020015	15	Conical	12,000	Triple-bagged packaging	Y	25	500
	CSP020050	50	Conical	12,000	Triple-bagged packaging	Y	25	500

CellSafe™ Conical Centrifuge Bottles

	Cat. No.	Volume (mL)	Bottom	Maximum RCF (xg)	Packaging	Sterile	Qty. Per Bag	Qty. Per Case
	CSP020250	250	Conical	7,500	Triple-bagged packaging	Y	6	48
	CSP020500	500	Conical	6,000	Triple-bagged packaging	Y	6	36

CellSafe™ Cell and Tissue Culture Flasks

	Cat. No.	Volume (mL)	Cell culture surface area (cm²)	Surface	Packaging	Sterile	Qty. Per Bag	Qty. Per Case
	CSP031250	250	75	TC-treated	Triple-bagged packaging	Y	1	40
	CSP031600	600	182	TC-treated	Triple-bagged packaging	Y	1	40
	CSP031225	850	225	TC-treated	Triple-bagged packaging	Y	1	24

CellSafe™ Cell and Tissue Culture Plates

	Cat. No.	Specification (well)	Well type	Recommended working volume of a single well (mL)	Packaging	Sterile	Qty. Per Bag	Qty. Per Case
	CSP040006	6	Flat bottom	1.9-2.9	Triple-bagged packaging	Y	10	100
	CSP040096	96	Flat bottom	0.0075-0.2	Triple-bagged packaging	Y	10	100

CellSafe™ Cell and Tissue Culture Dishes

	Cat. No.	Surface	Diameter (mm)	Height (mm)	Recommended working volume (mL)	Packaging	Sterile	Qty. Per Bag	Qty. Per Case
	CSP050150	TC-treated	150	22	25-50	Triple-bagged packaging	Y	1	120

CellSafe™ CellFac® Multi-Layer Cell Culture Systems

	Cat. No.	Type	Surface area (cm²)	Working volume (mL)	Surface	Packaging	Sterile	Qty. Per Bag	Qty. Per Case
	CSP060005	5-layer	3216	650-1,000	TC-treated	Triple-bagged packaging	Y	1	4
	CSP060010	10-layer	6416	1,300-2,000	TC-treated	Triple-bagged packaging	Y	1	2

CellSafe™ Erlenmeyer Flasks

	Cat. No.	Volume (mL)	Flask material	Cap	Packaging	Sterile	Qty. Per Bag	Qty. Per Case
	CSP070125	125	PC	Vent	Triple-bagged packaging	Y	1	24
	CSP070250	250	PC	Vent	Triple-bagged packaging	Y	1	12
	CSP070500	500	PC	Vent	Triple-bagged packaging	Y	1	12
	CSP070000	1,000	PC	Vent	Triple-bagged packaging	Y	1	12

CellSafe™ Vacuum Bottle Filters

	Cat. No.	Membrane Material	Pore Size (µm)	Volume (mL)	Membrane Diameter (mm)	Packaging	Sterile	Qty. Per Bag	Qty. Per Case
	CSP080500	PES	0.22	500	500	Triple bagged packaging	Y	1	12
	CSP081500	PES	0.45	500	500	Triple bagged packaging	Y	1	12
	CSP080000	PES	0.22	1,000	1,000	Triple bagged packaging	Y	1	12
	CSP081000	PES	0.45	1,000	1,000	Triple bagged packaging	Y	1	12



Stock Code: 688026

Others

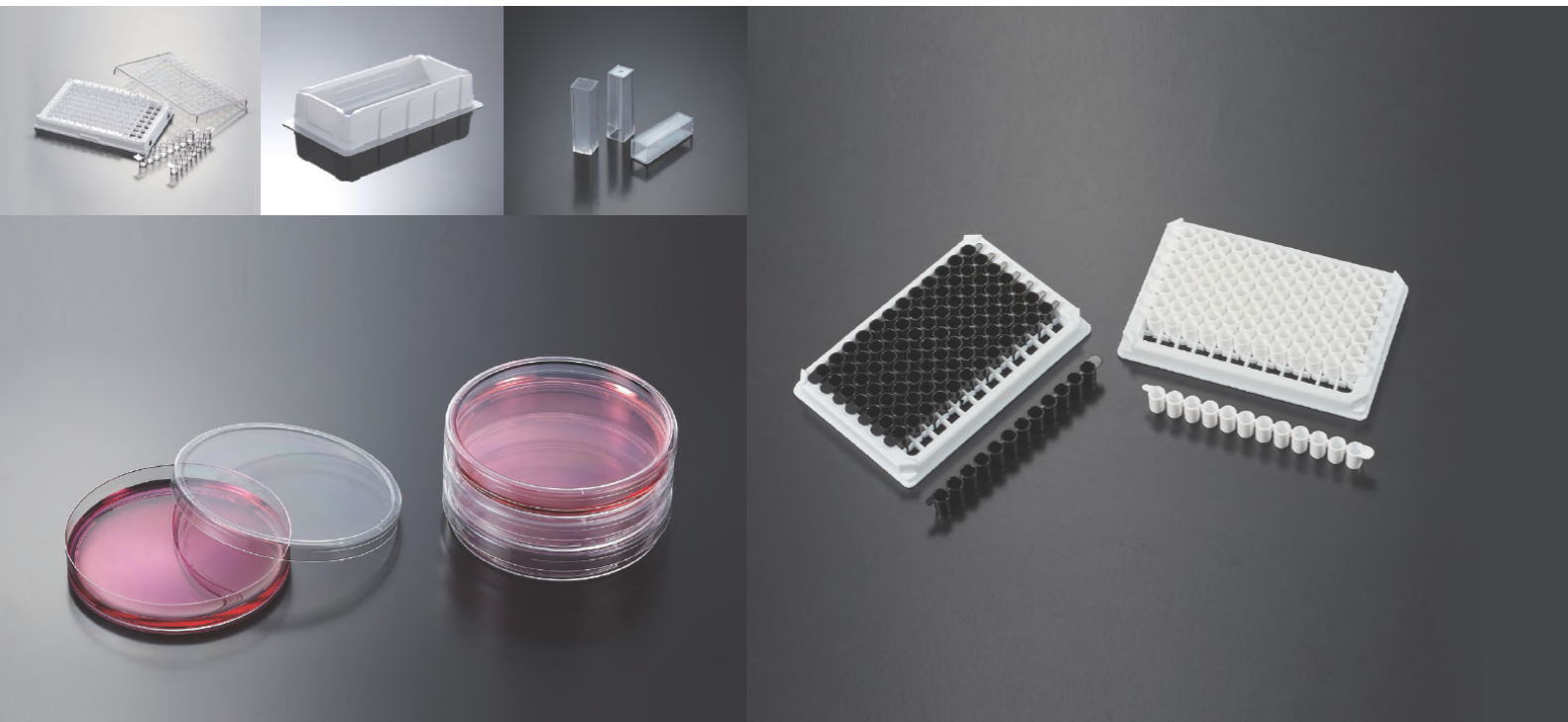

In addition to biolaboratory consumables for cell culture, liquid handling and filtration, JET BIOFIL also provides more convenient and commonly used experimental instruments and consumables for laboratories, including cuvettes, Petri dishes, loops, reservoirs, etc.

ELISA Plates

ELISA plates are an important tool for ELISA (enzyme-linked immunosorbent assay) experiments and are made of polystyrene (PS). Antigens, antibodies and biomolecules bind to the bottom surface of the plate by means of hydrophobic and ionic bonds.

The ELISA plates by Jet Biofil are made with international advanced surface treatment technologies and manufacturing processes for polymers, and show stable protein-binding properties. They can be used as safe, reliable and effective carriers during ELISA experiments, and in conjunction with immune and genetically modified products, as well as for clinical diagnosis.

- Specification: 96-well non-removable plate 96-well removable plate (with 8-well or 12-well strips)
- Binding force: High binding force Moderate binding force
- Materials: Polystyrene (PS) and high impact polystyrene (HIPS) , conforming to USP Class VI standards



Features

- Unique surface treatment process for higher protein adsorption properties
- 2 binding forces available: High binding force (300–400 ng/cm²), and moderate binding force (200–300 ng/cm²)
- 8-well and 12-well strips are provided to match the ELISA plates and for better cost-effectiveness
- Designed with a flat bottom and divided into removable and non-removable structures to satisfy different experimental applications
- Even well diameter and thickness, ensuring high experimental accuracy and repeatability
- Transparent plate, with a CV value <5%, higher and measurement flexibility; widely used in colorimetric determination
- Clearly marked with letters and numbers to distinguish the samples in different wells
- Dimensions conform to ANSI/SLAS international standards and are compatible with most brands of ELISA equipment
- Sterilized and non-sterilized available, sterilized by irradiation to SAL 10⁻⁶
- DNase/RNase-free, non-pyrogenic

High binding force ELISA plates

The plates have undergone surface treatment to increase the protein binding force to up to 300–400 ng/cm² (IgG); molecular weight of binding proteins: >10 kD. This type of ELISA plates can improve sensitivity and reduce coat protein concentration and usage. If absent, the non-ionic detergent will fail to block the binding protein, and nonspecific reactions could occur, meaning the protein would need to be used as a blocking agent.

Moderate binding force ELISA plates

The ELISA plate binds with proteins through hydrophobic bonds on the surface and is suitable for use as a solid phase carrier for macromolecule proteins with a molecular weight >20 kD. These plates have a protein binding capability of 200–300 ng/cm² (IgG). As the ELISA plate binds only with macromolecules, it is also suitable as a solid phase carrier for unpurified antibodies or antigens. Proteins or non-ionic detergents can be used as blocking liquid on these plates.

Type of ELISA Plate	Transmittance Variation (CV)	Binding Action	Sample Characteristics	Recommended Blocking Agent
High binding force plate 300–400 ng/cm ² (IgG)	<5.00%	Hydrophobic bond	Middle/macromolecular protein with positive charge >10kD	PBS containing 0.3% Tween 20, combination of 0.05% Tween 20 and 1%BSA
Moderate binding force plate 200–300 ng/cm ² (IgG)		Hydrophobic bond/ionic bond	Macromolecular protein >20KD	Tween 20 detergent used in combination with protein, BSA, skim milk and serum

Removable Stripes

Cat. No.	Specification	Binding Capacity	Description	Sterile	Qty.Per Bag(Box)	Qty.Per Case
FEP100012	12-well strip	High Binding	Flat Bottom (Fit with Removable Plate Frame)	Y	40	1600
FEP100008	8-well strip	High Binding		Y	60	2400
FEP200012	12-well strip	Medium Binding		N	40	1600
FEP200008	8-well strip	Medium Binding		N	60	2400

Plates

Cat. No.	Specification	Binding Capacity	Description	Sterile	Qty.Per Bag(Box)	Qty.Per Case
FEP100096	96-well	High Binding	Fixed flat bottom	Y	10	200
FEP111096	96-well	High Binding	Fixed flat bottom, with top	Y	10	200
FEP101896	96-well	High Binding	Removable flat bottom, with 8x12 strips	Y	10	200
FEP101296	96-well	High Binding	Removable flat bottom, with 12x8 strips	Y	10	200
FEP200096	96-well	Medium Binding	Fixed flat bottom	N	10	200
FEP201896	96-well	Medium Binding	Removable flat bottom, with 8x12 strips	N	10	200
FEP201296	96-well	Medium Binding	Removable flat bottom, with 12x8 strips	N	10	200

Serological Plates

Jet Biofil's Serological Plates are made of transparent high-polymer polystyrene (PS) material with untreated surfaces, making them ideal for solution analysis, serial dilution, colorimetric applications, protein and antigen-antibody concentration measurements, as well as general storage purposes. The plates offer high light transmittance, excellent chemical stability, and easy observation.

- Specifications: 96-well non-removable plate
96-well removable plate (with 8-well or 12-well strips)
- Bottom Type: Flat
- Materials: Non-removable plates: Polystyrene (PS), Plate strips: Polystyrene (PS), Removable plate frame: High-impact polystyrene (HIPS), conforming to USP Class VI standards

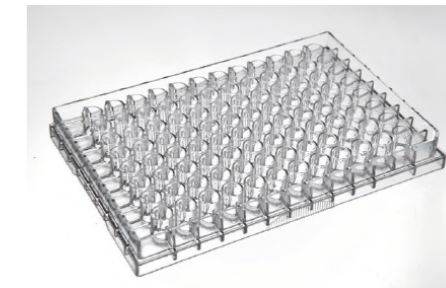

Cat. No.	Specification	Color	Bottom Type	Sterile	Qty. Per Box	Qty. Per Case
SLP000096	96-well, non-removable	Transparent	Flat	N	10	200
SLP010296	96-well, with 12-strips	Transparent	Flat	N	10	200
SLP010896	96-well, with 8-strips	Transparent	Flat	N	10	200

Immuno Micro Plates

The opaque multiple plates are made of polystyrene (PS) and have outstanding binding characteristics, making them the ideal choice for colorimetric determination. These opaque plates are suitable for fluorescence and luminescence tests, with the black immuno-micro plate usually used for fluorescence experiments. The opaque black surface reduces background interference from auto fluorescence, inter-well interference, and "light scattering", providing improved sensitivity. The white opaque immuno-micro plate is perfect for quantitative determination of bioluminescence or in other luminescence experiments. The immuno-micro plates support fast or continuous luminescence, providing improved measurement sensitivity.

- Specification: 96-well removable plate (with 8-well or 12-well strips)
- Color: White Black
- Materials: Polystyrene (PS) and High impact polystyrene (HIPS), conforming to USP Class VI standards

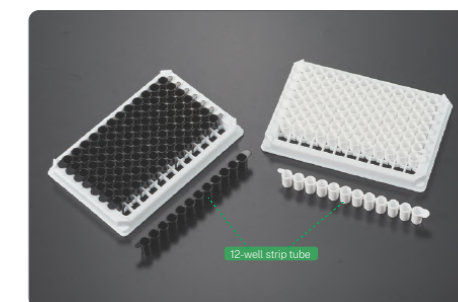

Features

- Available in white and black to satisfy the requirements of different experiments
- 8-well or 12-well strips for flexible selection based on samples
- Coordinated location of alphanumeric markings to facilitate operation and identification
- Good compatibility, suitable for use with most types of equipment
- Easy to use: Single-well operation as easy as row operation; compatible with all common instruments
- White immuno-micro plates reflect the light from luminescence reactions, ensuring reduced cross-contamination and low background effect
- The opaque black plate can reduce the background effect caused by auto-fluorescence and inter-well interference
- DNase/RNase-free, non-pyrogenic

Cat. No.	Well Qty.	Bottom	Specification	Color	Qty.Per Bag	Qty.Per Case
LTP010296	96	Removable	12-well strip x 8	White	10	200
LTP010896	96	Removable	8-well strip x 12	White	10	200
LTP021296	96	Removable	12-well strip x 8	Black	10	200
LTP021896	96	Removable	8-well strip x 12	Black	10	200

Petri Dishes

Petri dishes are the most basic and commonly used culture tools in microbiological laboratories for various operations such as inoculation and isolation of bacteria, as well as culturing of fungi, bacteria and other microorganisms. Jet Biofil's Petri dishes are made from high-quality polystyrene material, offering excellent optical clarity for easy observation of colony morphology. They are available in various sizes to meet the needs of laboratory cultures and automatic media dispenser.

- Specification: 35 mm 60 mm 70 mm 90 mm 90 mm (Extra Height) 100 mm 150 mm
- Materials: Polystyrene (PS), conforming to USP Class VI standards

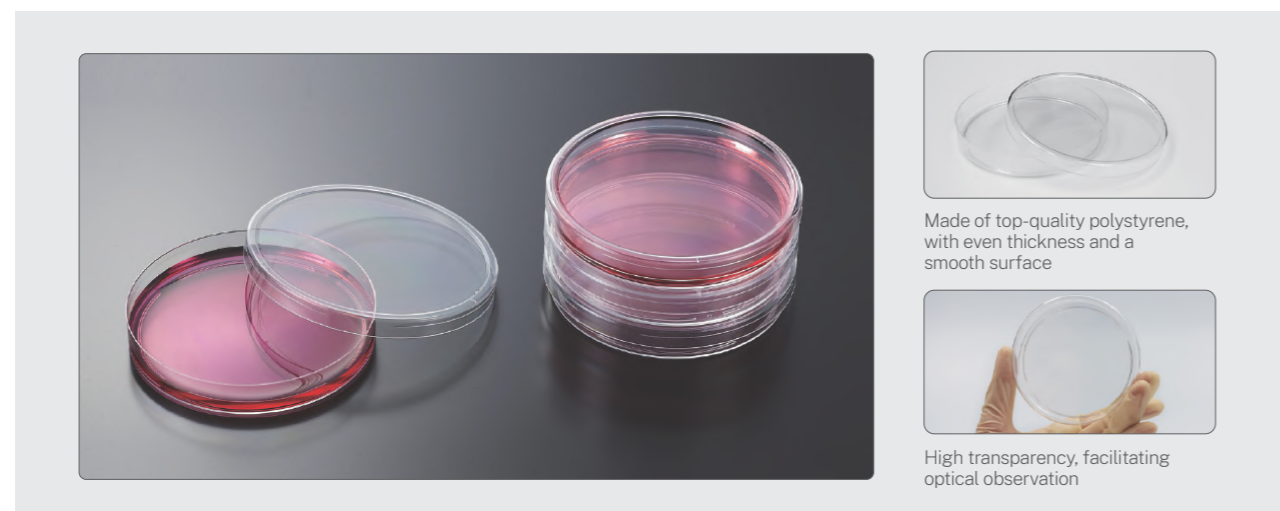

Features

- Made from high-transparency PS material, with uniform thickness and a flat, smooth bottom for excellent optical clarity
- Available in various heights, diameters, and weights to meet different experimental and production needs
- Features a positioning ring design for stable stacking of Petri dishes
- The inner side of the dish cover is designed for ventilation, allowing gas exchange while ensuring a sterile environment
- The 90mm high-profile Petri dish weighs 15.05g per unit, allowing stable rotation on a media dispenser carousel
- The 90mm Petri dish without a serrated ring weighs 12.99g per unit, providing smoother pushing on plate filling production lines
- Sterilized by irradiation (SAL 10⁻⁶) or Aseptic (Manufactured in Class 100,000 cleanrooms) both available
- DNase/RNase-free, non-pyrogenic

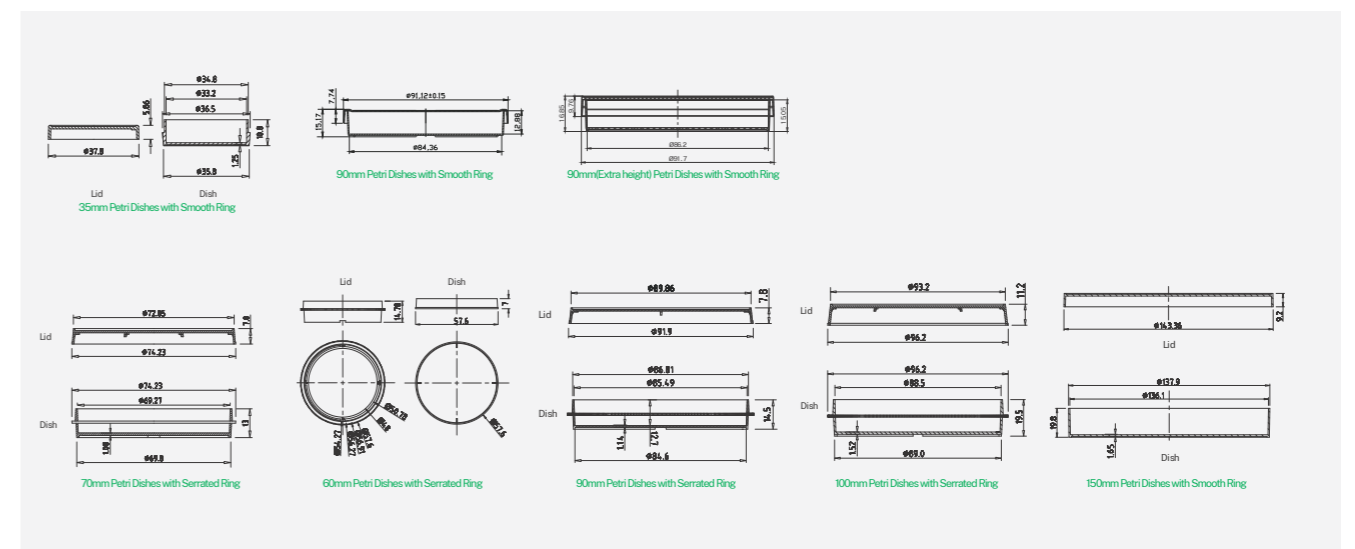

Petri Dishes with Serrated Ring

Cat. No.	Diameter (mm)	Height (mm)	Weight (g)	Sanitary Level	Qty. Per Bag	Qty. Per Case
MCD000060	φ 60	17.3	8.8	SAL 10 ⁻⁶	10	600
MCD000070	φ 70	15.5	13.7	SAL 10 ⁻⁶	10	600
MCD000090	φ 90	16.9	20.9	SAL 10 ⁻⁶	10	500
MCD000100	φ 100	22.6	29.5	SAL 10 ⁻⁶	10	300

Petri Dishes with Smooth Ring

Cat. No.	Diameter (mm)	Height (mm)	Weight (g)	Sanitary Level	Qty. Per Bag	Qty. Per Case
MCD000035	φ 35	12.6	4.1	SAL 10 ⁻⁶	10	960
MCD110090	φ 90	15.2	13.0	SAL 10 ⁻⁶	20	500
MCD111090	φ 90	15.2	13.0	SAL 10 ⁻⁶	20	500
MCD111090	φ 90	15.2	13.0	Aseptic	10	500
MCD300090	φ 90(Extra height)	16.9	15.1	Aseptic	20	500
MCD310090	φ 90(Extra height)	16.9	15.1	SAL 10 ⁻⁶	20	500
MCD000150	φ 150	22.7	60.8	SAL 10 ⁻⁶	1	120
MCD100150	φ 150	22.7	60.8	SAL 10 ⁻⁶	5	100

Height: total height that combines cap and dish

Partitioned Petri Dishes

Partitioned Petri dishes are designed based on Φ 90 mm standard Petri dishes, featuring a divided structure that allows simultaneous cultivation of multiple microorganisms. This design makes it convenient for researchers to observe and compare the growth characteristics of different microorganisms. JET BIOFIL's partitioned Petri dishes are manufactured with injection molding process, ensuring sturdy partition walls that are not easily detached and providing excellent compartmentalization. Various specifications are available to meet different needs for segregated microbial cultivation and observation.

- Specification: Bi-Partitioned Third-Partitioned Quad-Partitioned
- Materials: Polystyrene (PS), conforming to USP Class VI standards

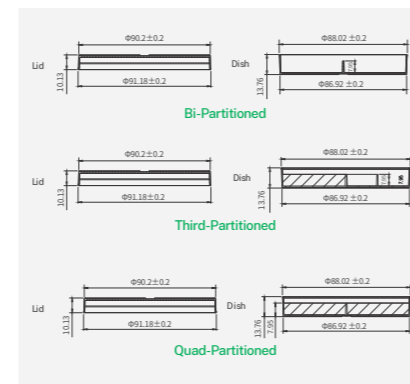
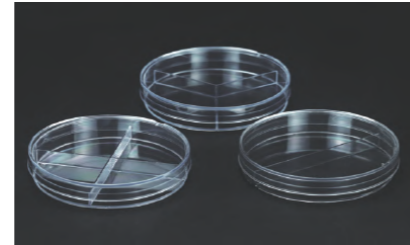

Features

- Injection molding processed, with sturdy partition walls that are not easily detached
- Partition walls providing excellent compartmentalization, enabling the cultivation of multiple microorganisms while effectively preventing cross-contamination
- Features a positioning ring design for stable and space-saving stacking of dishes
- Sterilized by irradiation (SAL 10^{-6}), DNase/RNase-free, non-pyrogenic

Cat. No.	Dimension (mm)	Partition	Height (mm)	Weight (g)	Sanitary Level	Qty. Per Bag	Qty. Per Case
MCD001090	Φ 90	2	15.5	17.8	SAL 10^{-6}	20	500
MCD002090	Φ 90	3	15.5	18.0	SAL 10^{-6}	20	500
MCD003090	Φ 90	4	15.5	19.3	SAL 10^{-6}	20	500

Height: total height that combines cap and dish

Contact Plate

Contact plate is a specialized type of Petri dish used for microbiological testing, primarily used to verify the quantity and types of microorganisms on surfaces. JET BIOFIL's contact plate is made from premium PS material, with uniform thickness and high transparency. The product is widely used in industries such as pharmaceuticals and food for microbial testing in clean environments.

- Specification: 60 mm
- Materials: Polystyrene (PS), conforming to USP Class VI standards

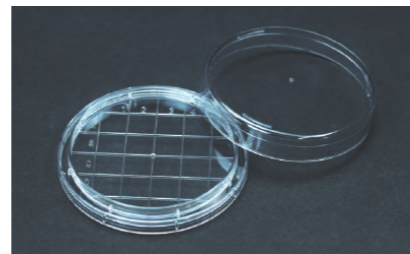

Features

- Made from premium PS material with uniform thickness and high transparency, allowing for easy observation of colony morphology
- The raised bottom design, which shapes the agar medium, facilitates convenient surface sampling
- The grippable edges design enables easy handling during operation
- Flat-bottom design, with counting grids (10x10 mm) and numerical indicators for subsequent colony counting and recording
- The side features multiple reinforcing ribs, achieving a tighter seal that prevent parts falling off when inverted
- Sterilized by irradiation (SAL 10^{-6}), DNase/RNase-free, non-pyrogenic

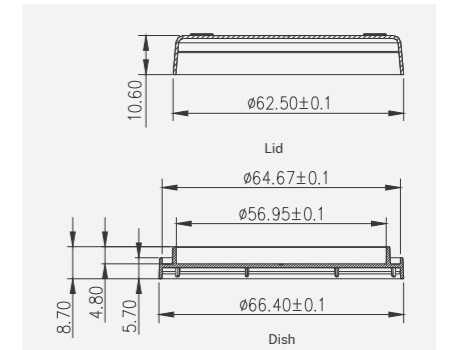

Cat. No.	Dimension (mm)	Inside Height (mm)	Recommended Working Volume (mL)	Weight (g)	Sanitary Level	Qty. Per Bag	Qty. Per Case
MCD001060	Φ 60	14.5	16-17	8.4	SAL 10^{-6}	20	1080

Height: total height that combines cap and dish

Inoculating Loops and Needles

Inoculating loops and needles are a common laboratory tool used in microbiological testing. JET BIOFIL inoculating loops and inoculating needles are made of polymer materials, and feature a treated, hydrophilic surface.

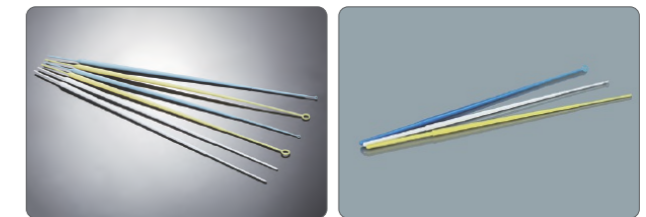

PS Material

PP Material

- Materials: Polypropylene(PP) / Polystyrene(PS)
- Conforming to USP Class VI standards

Features

- Hydrophilic surface
- Available in a variety of colors to distinguish loops and needles of different specifications
- Combination of inoculating loop and needle provides a dual-purpose function
- The inoculation needle shaft is slender and flexible, bendable, and can be used in narrow or special shaped containers
- Smooth ring edges to avoid damage to the medium surface
- Sterilized and non-sterilized available, sterilized by irradiation to SAL 10^{-6}
- DNase/RNase-free, non-pyrogenic

Cat. No.	Volume (μ L)	Length (mm)	Volume (μ L)	Length (mm)	Color	Sterile	Qty. Per Bag	Qty. Per Case
DIL101001	PS	Loops	1.0	228	Blue	Y	25	2000
DIL112001			1.0	228	Blue	Y	1	3000
DIL211001			1.0	228	Blue	Y	10	12000
DIL212001			1.0	228	Blue	Y	10	2000
DIL101010			10.0	228	Yellow	Y	25	2000
DIL112010			10.0	228	Yellow	Y	1	3000
DIL211010			10.0	228	Yellow	Y	10	12000
DIL212010			10.0	228	Yellow	Y	10	2000

Cat. No.	Volume (μL)	Length (mm)	Volume (μL)	Length (mm)	Color	Sterile	Qty. Per Bag	Qty. Per Case	
DIL220001	PS	Needles	-	228	White	Y	25	2000	
DIL222001			-	228	White	Y	1	3000	
DIL221001			-	228	White	Y	10	12000	
DIL223001			-	228	White	Y	10	2000	
DIL010001	PP	Loops	1.0	218	White	N	20	2000	
DIL011001			1.0	218	White	Y	20	2000	
DIL111001			1.0	219	White	Y	1	3000	
DIL010010			10.0	220	Blue	N	20	2000	
DIL011010			10.0	220	Blue	Y	20	2000	
DIL111010			10.0	220	Blue	Y	1	3000	
DIL020001			Needles	-	218	Yellow	N	20	2000
DIL021001				-	218	Yellow	Y	20	2000
DIL121001				-	218	Yellow	Y	1	3000

Graduated Urine Centrifuge Tubes

Graduated urine centrifuge tubes are mainly used for collecting and storing urine samples.



- ◎ Specification: 15 mL
- ◎ Materials: Polystyrene (PS), conforming to USP Class VI standards

Features

- ◎ Smooth and transparent tube with clear and accurate scale
- ◎ Maximum RCF: 1,500×g
- ◎ Passed rigorous leakage test
- ◎ DNase/RNase-free, non-pyrogenic

Cat. No.	Volume (mL)	Description	RCF(xg)	Sterile	Qty. Per Bag	Qty. Per Case
CFT418150	15	PS, plug seal cap	1,500×g	N	1000	1000
CFT419150	15	PS, without cap	1,500×g	N	100	1000
CFT420150	15	Graduated urine centrifuge cap	-	N	500	1000

Cuvettes

Cuvettes are a common consumable in spectral laboratory analysis. The JET BIOFIL cuvettes are made of transparent polymer, polystyrene (PS), for its broad chemical compatibility, and can be used for optical determination of most polar organic solutions, weak acidic solutions and weak alkaline solutions.

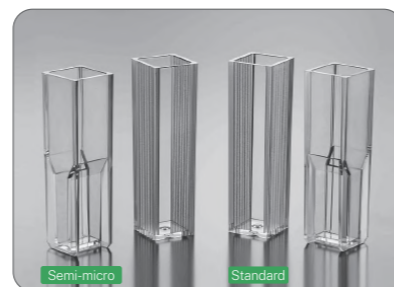

- ◎ Materials: Polystyrene (PS), conforming to USP Class VI standards

Features

- ◎ Available as standard type and semi-micro type (spectral range: 400 nm to 800 nm, optical path: 10 mm)
- ◎ Made of high-quality optical plastic with broad chemical compatibility
- ◎ Thanks to precision optical processing technology, the optical performance error of the light transmission surface is $\leq 0.3\%$
- ◎ Recessed window reduces the risk of scratches during use
- ◎ Matte surface provides an ideal labelling and operating area
- ◎ The semi-micro cuvette is marked with a light path arrow to ensure the consistency of projection direction

Cat. No.	Type	Volume (mL)	Recommended Working Capacity (mL)	Optical Path (mm)	Optical Windows (piece)	Sterile	Qty. Per Box	Qty. Per Case
CUV010015	Semi-micro	1.50	1-1.5	10	2	N	100	1000
CUV010045	Standard	4.50	3-4	10	2	N	100	1000

Latex Powder-free Gloves

These disposable examination gloves are used extensively in biological and medical experiments and examinations to not only protect the operators' hands, but also to prevent hand contamination due to contact.



- ◎ Specification: XS S M L
- ◎ Materials: Latex

Features

- ◎ Disposable latex examination gloves, powder-free, non-sterile
- ◎ Natural latex, high protection and flexibility in one
- ◎ High tensile strength, not easy to break, reduces glove loss
- ◎ Superior coating technology – the coating does not fall off easily, blocks allergic factors, reduces sensitivity and enhances wearing comfort

Cat. No.	Product Description	Color	Sterile	Size	Weight(g)	Qty. Per Box	Qty. Per Case
GVL100101	Latex, powder-free, coating technology, fully textured	White	N	L	5.8	100	1000
GVM100102	Latex, powder-free, coating technology, fully textured	White	N	M	5.8	100	1000
GVS100103	Latex, powder-free, coating technology, fully textured	White	N	S	5.8	100	1000
GVS100104	Latex, powder-free, coating technology, fully textured	White	N	XS	5.8	100	1000
GVL110101	Latex, powder-free, coating technology, fully textured	Light Yellow	Y	L	5.8	100	1000
GVM110102	Latex, powder-free, coating technology, fully textured	Light Yellow	Y	M	5.8	100	1000
GVS110103	Latex, powder-free, coating technology, fully textured	Light Yellow	Y	S	5.8	100	1000
GVS110104	Latex, powder-free, coating technology, fully textured	Light Yellow	Y	XS	5.8	100	1000



— Stock Code: 688026 —

Bioproduction Scaling-up



In recent decades, with the continuous innovation and rapid development of life science and technology, the science of human life and medical science have gradually become more dependent on biological products. The traditional method of extracting biological products from animal tissues by biochemical technologies is no longer able to meet market demands, and therefore, a new technology prevails in the current days in which cells are extracted from animal tissues and cultured on a large scale in vitro to produce mAbs, specific proteins, IFNs and viral vaccines, and cellular therapy products.

Adhering to the spirit of innovation, JET BIOFIL focuses on the R&D of core technologies and has developed a series of biotechnical R&D instruments for bioprocess, such as multi-layer cell culture systems, multi-layer cell culture flasks and large-capacity erlenmeyer flasks, which not only save time, space, and manpower required for bioprocesses, but also minimize the risk of contamination. All products are DNase/RNase and pyrogen-free, non-cytotoxic and produced in a Class 100,000 clean workshop in strict accordance with ISO 9001:2015 and ISO 13485:2016 using high-quality raw materials that conform to USP Class VI standards. They have shown stable performance when subjected to cell line testing and strict quality validation. In addition, biosafety test and biocompatibility test reports provided by a third party are available to meet the demand for high quality in bioprocesses.

NBR Gloves

NBR gloves are used extensively in biological and medical experiments and examinations. They are the first choice for a variety of different experiments, as well as detailed inspections and examinations, as they provide a better fit while supporting more flexible operations. Hypoallergenic.



- Specification: XS S M L
- Materials: Nitrile butadiene rubber (NBR)

Features

- Disposable NBR examination gloves, powder-free and non-sterile
- Thin and hypoallergenic, contain no allergenic latex proteins
- High degree of protection against acids, alkalis, oils and chemicals
- Tough and elastic with good impermeability
- Thin and flexible, able to improve sense of touch for both hands, economical and practical

Cat. No.	Product Description	Color	Size	Weight (g)	Qty. Per Box	Qty. Per Case
GVL200101	Butyronitrile, powder-free, rubber and fingertip textured surface	Blue	L	3.5	100	1000
GVM200102	Butyronitrile, powder-free, rubber and fingertip textured surface	Blue	M	3.5	100	1000
GVS200103	Butyronitrile, powder-free, rubber and fingertip textured surface	Blue	S	3.5	100	1000
GVS200104	Butyronitrile, powder-free, rubber and fingertip textured surface	Blue	XS	3.5	100	1000

CellFac® Multi-Layer Cell Culture System

The CellFac® Multi-Layer cell culture systems are made of the medical-grade polymers. National patent numbers of product structure: ZL201220167380.4 & ZL201220167162.0.

It features a large cell growth surface area, which allows for high cell growth density and a large number of cells to be cultivated and harvested each time. The device offers significant savings in terms of materials, labor costs and time required for repeated rounds of cultivation. It also avoids the risk of cell contamination when adding liquids or performing inoculation and cell harvesting. The device has been widely applied to large-scale cell cultures and production of various biological products (such as vaccines, monoclonal antibodies, and virus packaging). It can be used for scientific research, laboratory-scale production and small/medium industrial production.

The JET BIOFIL CellFac® Multi-Layer cell culture systems are produced in a Class 100,000 cleanroom, with production quality managed in strict accordance with GMP standards. Safe and mature production techniques are used to ensure each process undergoes stringent validation. Based on third-party test results, all key indicators for finished products, such as extractables, biological compatibility and bio-safety are compliant with the standards including the Chinese Pharmacopeia, ISO, and USP.

- Specification: 1 layer 2 layers 5 layers 10 layers 20 layers 40 layers
- Cap Type: Plug Seal Vent
- Surface: TC-treated Non-treated
- Materials: Bottle: Polystyrene (PS), Bottle Cap: High-density Polyethylene (HDPE), Filter Membrane: Polytetrafluoroethylene (PTFE), conforming to USP Class VI standards

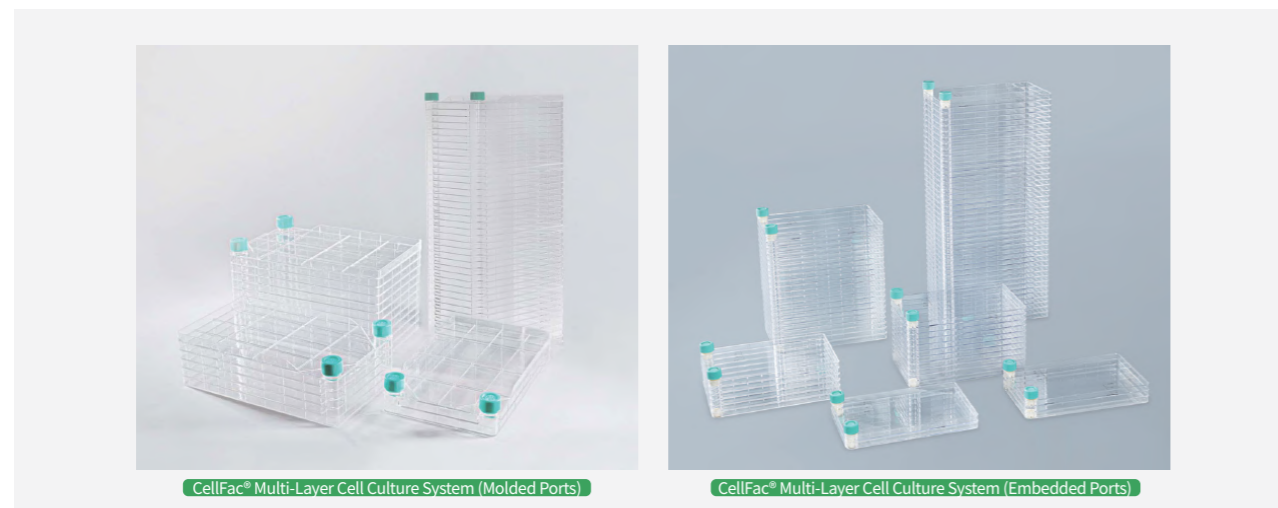

Features

- The cell culture systems are made of medical-grade polymers and produced in a dedicated cleanroom conforming to GMP standards
- Suitable for batch proliferation culture of adherent cells. Different specifications are available to satisfy different experimental demands
- Advanced ultrasonic welding techniques ensure high mechanical strength, while the absence of additives reduces the generation of unknown soluble substances and weldig impurities
- Even, stable surface processes ensure an optimal culture environment for high-yield cell cultures
- 0.22 µm hydrophobic and ventilated vent cap ensures sterility and facilitates continuous gas exchange
- All channels within the cell culture system are large in size, enabling faster medium distribution and reducing the appearance of foams
- Extremely low extractable levels and excellent biosafety, multiple assessments verified
- Every system is printed with lot No. for quality traceability
- Sterilized by irradiation, SAL 10⁻⁶
- DNase/RNase-free, non-pyrogenic, non-cytotoxic

CellFac® Multi-Layer Cell Culture System (Embedded Ports)

Cat. No.	Layers	Growth Surface Area (cm ²)	Working Volume (mL)	Dimensions(mm)			Surface	Cap	Sterile	Qty. Per Bag	Qty. Per Case
				L	W	H (Cap included)					
UCF050001	1	642	130-200	336	207	60	Non-treated	Vent cap: 0.22 µm, PTFE (2 additional plug sealed cap Per case)	Y	1	8
UCF050002	2	1284	260-400	336	207	77			Y	1	6
UCF050005	5	3210	650-1000	336	207	128			Y	1	4
UCF050010	10	6420	1300-2000	336	207	213			Y	1	2
UCF050020	20	12840	2600-4000	336	207	384			Y	1	2
UCF250040	40	25680	5200-8000	336	207	725	TC-treated		Y	1	1
UCF051001	1	642	130-200	336	207	60			Y	1	8
UCF051002	2	1284	260-400	336	207	77			Y	1	6
UCF051005	5	3210	650-1000	336	207	128			Y	1	4
UCF051010	10	6420	1300-2000	336	207	213			Y	1	2
UCF051020	20	12840	2600-4000	336	207	384	Y	1	2		
UCF251040	40	25680	5200-8000	336	207	725	Y	1	1		

CellFac® Multi-Layer Cell Culture System (Molded Ports)

Cat. No.	Layers	Growth Surface Area (cm ²)	Working Volume (mL)	Dimensions(mm)			Surface	Cap	Sterile	Qty. Per Bag	Qty. Per Case
				L	W	H (Cap included)					
UCF010001	1	656	130-200	335	205	48	Non-treated	Vent cap: 0.22 µm, PTFE (2 additional 0.22 µm PTFE vent cap Per case)	Y	1	8
UCF010002	2	1296	260-400	335	205	65			Y	1	6
UCF010005	5	3216	650-1000	335	205	116			Y	1	4
UCF010010	10	6416	1300-2000	335	205	200			Y	1	2
UCF011001	1	656	130-200	335	205	48	TC-treated		Y	1	8
UCF011002	2	1296	260-400	335	205	65			Y	1	6
UCF011005	5	3216	650-1000	335	205	116			Y	1	4
UCF011010	10	6416	1300-2000	335	205	200			Y	1	2

Guidelines For Use

- Unscrew the cap and slowly pour the medium into the Multi-Layer Cell Culture System, and tighten the cap
- Slowly place the Multi-Layer Cell Culture System on its side toward the inlet to balance the liquid level
- Slowly turn over the Multi-Layer Cell Culture System 90° with the inlet side on top, and the medium will be distributed evenly into each layer after standing
- Holding the inlet side with your hands, slowly tilt the Multi-Layer Cell Culture System until it is in a horizontal position, and place it in the cell culture incubator
- During cell culture, keep it horizontal
- When the culture is complete, loosen the cap and carefully pour the medium into a bottle to collect the cells

Jet CellFac® Multi-Layer Cell Culture System Accessories



MPC Transfer Cap

Cat. No.	Description
UCF428001	Male MPC, Light Green, Sterile, 1 per/bag, 10 per/case
UCF428002	Female MPC, Light Green, Sterile, 1 per/bag, 10 per/case

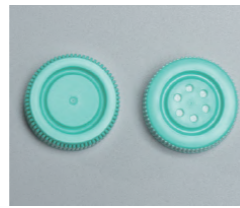

Cap

Cat. No.	Description
UCF411002	Light Green, Sterile, 1 per/bag, 10 per/case
UCF412002	Light Green, Sterile, 1 per/bag, 10 per/case



Large Hole Conversion Cover

Cat. No.	Description
UCF413002	Conversion cover, filter connection cover, connects to a hose with an inner diameter of 3/8 inch (9.5 mm), sterile, 1 pcs/bag, 10 pcs/carton



Small Hole Conversion Cover

Cat. No.	Description
UCF414002	Conversion cover, filter connection cover, big mouth to small mouth, 1 per/bag, 10 per/case



Hose Clamp

Cat. No.	Description
UCF418001	Clamps hoses with an outer diameter of 12 mm-18 mm, 1 per/bag, 10 per/case



Adapter

Cat. No.	Description
UCF415001	Connects with #17 hose and 30 mm filter, 1 per/bag, 10 per/case



Hose

Cat. No.	Description
UCF419001	3/8 inch (9.5 mm) inner diameter and 1/2 inch (12.7 mm) outer diameter



Hose

Cat. No.	Description
UCF421001	#17Hose



Filter Combination Cover

Cat. No.	Description
UCF416001	30 mm, PTFE 0.22 µm filter, #17 hose, small port conversion cover, 1 set/bag, 1 bag/box



Filter Combination Cover

Cat. No.	Description
UCF417001	50 mm, PTFE, 0.22 µm filter, 3/8 inch (9.5 mm) inner diameter hose, large mouth conversion cover, 1 set/bag, 1 bag/box



Syringe Driven Filter

Cat. No.	Description
PTF205030	30 mm, PTFE 0.2 µm



Syringe Driven Filter

Cat. No.	Description
PTF225050	50 mm, PTFE 0.2 µm

Erlenmeyer Flasks

As the ideal choice for suspension cell culture, Erlenmeyer flasks are used in the screening of industrial microbial strains, large-scale proliferation tests, and seed cultures. They can also be used for media preparation, mixing, storage, and other purposes. They are more cost-efficient than culture bottles, dishes and spinner bottles.

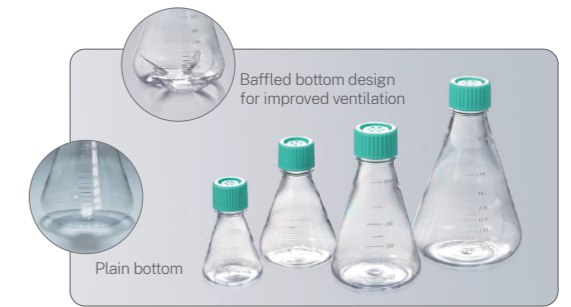

- Specification: 125 mL 250 mL 500 mL 1000 mL
- Bottom Type: Plain Baffled
- Cap Type: Plug Seal Vent
- Materials: Flask Body: Polycarbonate (PC)/Polyethylene terephthalate glycol (PETG), Bottle Cap: High-density polyethylene (HDPE), Cap Filter Membrane: Polytetrafluoroethylene (PTFE), conforming to USP Class VI standards

Features

- Even, transparent body features a clear and accurate graduation for volume observation
- Flask neck is lengthened for an easier grip. Liquid sticking-resistant design at the bottle neck enables easier pouring
- PC material supports autoclave sterilization for one time(repeated autoclaved sterilization is not recommended; autoclaved sterilization must not be performed for the vent cap)
- Extremely low extractable levels and excellent biosafety, multiple assessments verified
- 0.22 µm PTFE hydrophobic and breathable vent cap facilitates continuous gas exchange while ensuring sterility
- PETG material shrinks under autoclave sterilization to reduce biohazard residue
- 100% passing rate for production line air tightness test to ensure no leakage occurs
- Sterilized by irradiation, SAL 10⁻⁶
- DNase/RNase-free, non-pyrogenic, non-cytotoxic

Erlenmeyer Flask with Plain Bottom

Cat. No.	Specification (mL)	Material of Bottle Body	Cap Type	Sterile	Qty. Per Bag	Qty. Per Case
TAB101125	125	PETG	Plug Seal	Y	1	24
TAB102125	125	PETG	Vent	Y	1	24
TAB101250	250	PETG	Plug Seal	Y	1	12
TAB102250	250	PETG	Vent	Y	1	12
TAB101500	500	PETG	Plug Seal	Y	1	12
TAB102500	500	PETG	Vent	Y	1	12
TAB101000	1000	PETG	Plug Seal	Y	1	24
TAB102000	1000	PETG	Vent	Y	1	24
TAB001125	125	PC	Plug Seal	Y	1	24
TAB002125	125	PC	Vent	Y	1	24
TAB001250	250	PC	Plug Seal	Y	1	12
TAB002250	250	PC	Vent	Y	1	12
TAB001500	500	PC	Plug Seal	Y	1	12
TAB002500	500	PC	Vent	Y	1	12
TAB001000	1000	PC	Plug Seal	Y	1	24
TAB002000	1000	PC	Vent	Y	1	24

Erlenmeyer Flask with Baffled Bottom

Cat. No.	Specification (mL)	Material of Bottle Body	Cap Type	Sterile	Qty. Per Bag	Qty. Per Case
TAB11125	125	PETG	Plug Seal	Y	1	24
TAB112125	125	PETG	Vent	Y	1	24
TAB11250	250	PETG	Plug Seal	Y	1	12
TAB112250	250	PETG	Vent	Y	1	12
TAB11500	500	PETG	Plug Seal	Y	1	12
TAB112500	500	PETG	Vent	Y	1	12
TAB111000	1000	PETG	Plug Seal	Y	1	24
TAB112000	1000	PETG	Vent	Y	1	24
TAB01125	125	PC	Plug Seal	Y	1	24
TAB012125	125	PC	Vent	Y	1	24
TAB011250	250	PC	Plug Seal	Y	1	12
TAB012250	250	PC	Vent	Y	1	12
TAB011500	500	PC	Plug Seal	Y	1	12
TAB012500	500	PC	Vent	Y	1	12
TAB011000	1000	PC	Plug Seal	Y	1	24
TAB012000	1000	PC	Vent	Y	1	24

Features

- The flask body is made of polycarbonate (PC) material that has high transparency, strong impact resistance and high temperature resistance of up to 121°C.
- The circular arc design at the flask neck and the frosting process treatment enable an easy grip, and the anti-drip design at the flask mouth enables easy pouring.
- The unique drain neck design of the 5 L erlenmeyer flask prevents liquid splashing when pouring.
- Optional handles are available for the 5 L Erlenmeyer flask for easy access.
- The bottom of the flask is fully flat and can be stably placed on a tabletop shaker to effectively control the amount of foam.
- 0.22 µm PTFE hydrophobic and breathable vent cap facilitates continuous gas exchange while ensuring sterility and preventing leakage.
- Subjected to strict sealing, drop, flatness and other series of tests to ensure product quality.
- Indication of batch number on each product package to ensure quality traceability.
- Extremely low extractable levels and excellent biosafety, multiple assessments verified
- Sterilized by irradiation, SAL 10⁻⁶
- DNase/RNase-free, non-pyrogenic and non-cytotoxicity.

Cat. No.	Capacity	Material of Flask Body	Type of Cap	Sterile	Qty. Per Bag	Qty. Per Case
TAB001002	2 L	PC	Plug Seal	Y	1	6
TAB002002	2 L	PC	Vent	Y	1	6
TAB001003	3 L	PC	Plug Seal	Y	1	4
TAB002003	3 L	PC	Vent	Y	1	4
TAB001005	5 L	PC	Plug Seal	Y	1	4
TAB002005	5 L	PC	Vent	Y	1	4
TAB502005	5 L (with handle)	PC	Vent	Y	1	4

Large-capacity Erlenmeyer Flasks

Large-capacity erlenmeyer flasks are mainly used for large-scale expansion and culture of suspension cells and bacteria, etc., as well as for preparation, storage and transfer of culture medium. Because large-capacity erlenmeyer flasks can greatly improve cultivation efficiency, they have been widely used in cell biology, microbiology and other fields.

- Specification : 2 L 3 L 5 L 5 L (with handle)
- Cap style : Plug Seal Cap Vent Cap
- Materials: Flask body: Polycarbonate (PC), Flask cap: High-density polyethylene (HDPE), Filter membrane polytetrafluoroethylene (PTFE), conforming to USP Class VI standards

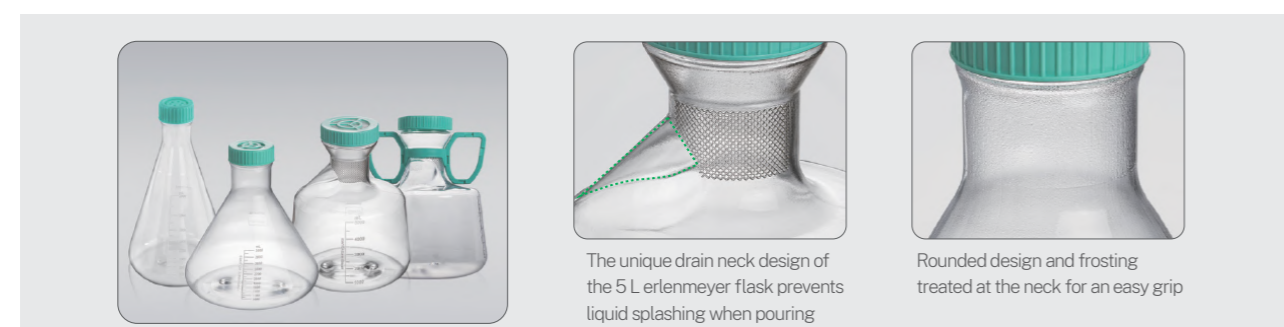

Multi-layer Cell Culture Flasks

The multi-layer cell culture flasks are available in 3 or 5 layers, providing 525 cm² and 875 cm² cell growth surface area, respectively. They are equivalent to 3 and 5 times the surface area of a T175 culture flask. The higher-capacity design makes cell culture faster, easier, and more efficient.

- Cap Type: Plug Seal Vent
- Surface: TC-treated
- Materials: Flask Body: Polystyrene (PS), Flask Cap: High-density Polyethylene (HDPE)
Filter Membrane: Polytetrafluoroethylene (PTFE), conforming to USP Class VI standards

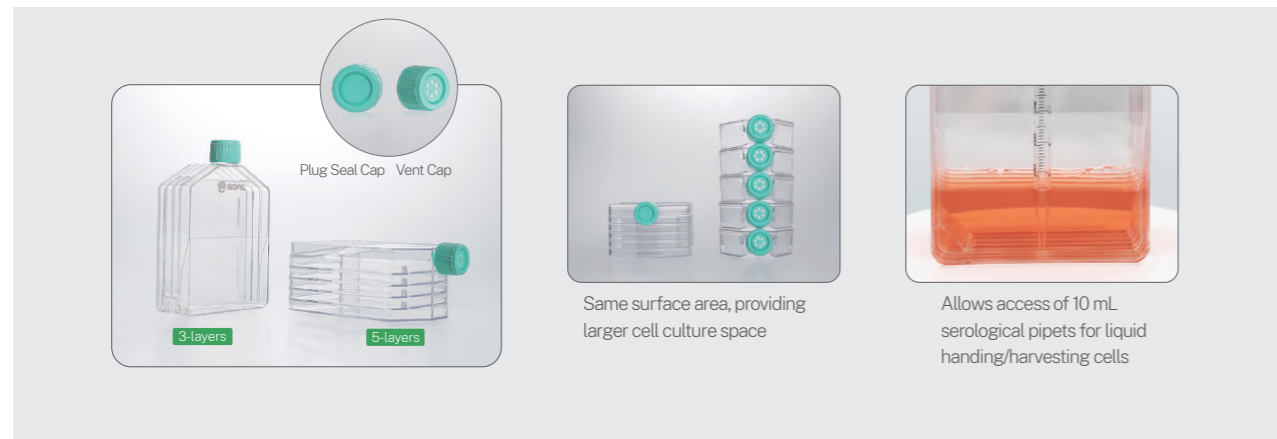

Features

- The medium can be evenly distributed across each layer, providing a consistent culture environment for uniform cell growth
- Every flask is printed with the lot No. for quality traceability
- Cells and reagents can be mixed directly in the flask, with no leakage or splash between layers, saving time and reducing the risk of contamination
- Suitable for 10 mL serological pipets for liquid aspiration/replenishment or cells harvesting directly in the flask
- The surface treatment of each layer is uniform and stable, effectively guaranteeing scaled-up cell cultures
- Extremely low extractable levels and excellent biosafety, multiple assessments verified
- Sterilized by irradiation, SAL 10⁻⁶
- DNase/RNase-free, non-pyrogenic, non-cytotoxic

Cat. No.	Layer	Surface	Cell Growth Area (cm ²)	Type of Cap	Dimensions(mm)				Sterile	Qty. Per Bag	Qty. Per Case
					L	W	H	B.N.D			
TCF011525	3	TC-treated	525	Plug Seal	196.7	127.2	55.6	26	Y	2	12
TCF012525	3		Vent	196.7	127.2	55.6	26	Y	2	12	
TCF011875	5		Plug Seal	196.7	127.2	80.2	26	Y	1	8	
TCF012875	5		Vent	196.7	127.2	80.2	26	Y	1	8	

*Bottle Neck Diameter

Roller Bottles

Roller bottles are high-quality consumables that can meet the requirements of large-scale cell and tissue culture for experimental and industrial production. They are mainly used in laboratory cell research and in the industrial production of biological products, including recombinant proteins, monoclonal antibodies, virus vaccines, and cell secretions.

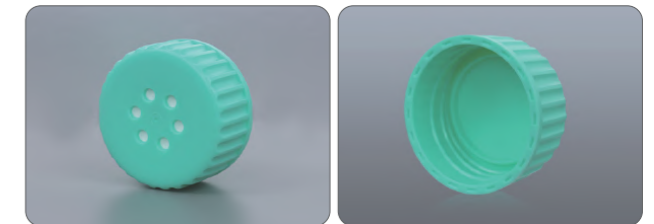

- Specification: 1000 mL 2000 mL 3000mL 5000 mL
- Cap Type: Plug Seal Vent
- Surface: Non-treated TC-treated
- Materials: Bottle Body: Polystyrene (PS), Bottle Cap: High-density Polyethylene (HDPE), Cap Filter Membrane: Polytetrafluoroethylene (PTFE), conforming to USP Class VI standards

Features

- The lid is ergonomically designed with thick stripes for easy screwing, thereby improving efficiency
- Printed graduation marks facilitate easy recording
- Suitable for all common instruments and automation equipment
- Smooth and groove bottle surfaces are available. Groove surface bottles provide a larger culture area than smooth surface bottles with the same volume
- Integrally molded, 100% undergone for production line air tightness test
- Every bottle is printed with the lot No. for quality traceability
- Extremely low extractable levels and excellent biosafety, multiple assessments verified
- Sterilized by irradiation, SAL 10⁻⁶
- DNase/RNase-free, non-pyrogenic, non-cytotoxic

Expanded Surface Roller Bottles, TC-treated

Cat. No.	Volume (mL)	Appro. Cell Growth Area (cm ²)	Working Volume (mL)	Cap Style	Height (mm)	B.D* (mm)	B.N.D* (mm)	Sterile	Qty. Per Pack	Qty. Per Case
TCB031002	2000	1900	300-400	Plug seal	273.5	116.5	44.9	Y	1	12
TCB032002	2000	1900	300-400	Vent	273.5	116.5	44.9	Y	1	12
TCB031102	2000	1900	300-400	Easy grip plug seal	273.5	116.5	44.9	Y	1	12
TCB032102	2000	1900	300-400	Easy grip vent	273.5	116.5	44.9	Y	1	12
TCB031005	5000	4250	850-1300	Plug seal	500.0	121.5	44.9	Y	1	12
TCB032005	5000	4250	850-1300	Vent	500.0	121.5	44.9	Y	1	12

B.D: Bottom Diameter / B.N.D: Bottle Neck Diameter

Expanded Surface Roller Bottles, Non-treated

Cat. No.	Volume (mL)	Working Volume (mL)	Cap Style	Height (mm)	B.D* (mm)	B.N.D* (mm)	Sterile	Qty. Per Pack	Qty. Per Case
TCB021002	2000	300-400	Plug seal	273.5	116.5	44.9	Y	1	12
TCB022002	2000	300-400	Vent	273.5	116.5	44.9	Y	1	12
TCB021005	5000	340-510	Plug seal	500.0	121.5	44.9	Y	1	12
TCB022005	5000	340-510	Vent	500.0	121.5	44.9	Y	1	12

B.D: Bottom Diameter / B.N.D: Bottle Neck Diameter

Roller Bottles, TC-treated

Cat. No.	Volume(mL)	Appro. Cell Growth Area (cm ²)	Working Volume (mL)	Cap Style	Height (mm)	B.D* (mm)	B.N.D* (mm)	Sterile	Qty. Per Pack	Qty. Per Case
TCB011001	1000	490	100-150	Plug seal	175.5	116.5	44.9	Y	1	24
TCB012001	1000	490	100-150	Vent	175.5	116.5	44.9	Y	1	24
TCB011002	2000	850	180-260	Plug seal	273.5	116.5	44.9	Y	1	12
TCB012002	2000	850	180-260	Vent	273.5	116.5	44.9	Y	1	12
TCB01102	2000	850	180-260	Easy grip plug seal	273.5	116.5	44.9	Y	1	12
TCB012102	2000	850	180-260	Easy grip vent	273.5	116.5	44.9	Y	1	12
TCB011003	3000	1550	310-470	Plug seal	480.0	110.0	44.9	Y	1	12
TCB012003	3000	1550	310-470	Vent	480.0	110.0	44.9	Y	1	12
TCB011005	5000	1700	340-510	Plug seal	500.0	121.5	44.9	Y	1	12
TCB012005	5000	1700	340-510	Vent	500.0	121.5	44.9	Y	1	12

B.D: Bottom Diameter / B.N.D: Bottle Neck Diameter

Roller Bottles, Non-treated

Cat. No.	Volume(mL)	Working Volume (mL)	Cap Style	Height (mm)	B.D* (mm)	B.N.D* (mm)	Sterile	Qty. Per Pack	Qty. Per Case
TCB001001	1000	100-150	Plug seal	175.5	116.5	44.9	Y	1	24
TCB002001	1000	100-150	Vent	175.5	116.5	44.9	Y	1	24
TCB001002	2000	180-260	Plug seal	273.5	116.5	44.9	Y	1	12
TCB002002	2000	180-260	Vent	273.5	116.5	44.9	Y	1	12
TCB001102	2000	180-260	Easy grip plug seal	273.5	116.5	44.9	Y	1	12
TCB002102	2000	180-260	Easy grip vent	273.5	116.5	44.9	Y	1	12
TCB001003	3000	310-470	Plug seal	480.0	110.0	44.9	Y	1	12
TCB002003	3000	310-470	Vent	480.0	110.0	44.9	Y	1	12
TCB001005	5000	340-510	Plug seal	500.0	121.5	44.9	Y	1	12
TCB002005	5000	340-510	Vent	500.0	121.5	44.9	Y	1	12

B.D: Bottom Diameter / B.N.D: Bottle Neck Diameter

Cell Culture Bags

Cell culture bags are closed cell culture systems designed for large-scale in vitro suspension culture of human lymphocytes, such as T cells, NK cells, and CIK cells.

Jet Biofil's Cell Culture Bags are made of medical-grade, low-density polyethylene membranes that meet USP Class VI standards. These membranes support continuous gas exchange while effectively preventing contamination from bacteria and viruses. With high transparency, the bags allow direct observation of cell morphology under a microscope. During use, media, cytokines, and samples can be easily added or removed. Produced in GMP-grade cleanrooms, these culture bags have very low extractable levels and great biosafety, making them ideal for immune cell proliferation and culture in a closed in vitro environment.

- Specifications: 500 mL -TPE Tubing 500 mL -PVC Tubing 2 L -PVC Tubing 3 L -PVC Tubing
- Materials: Bag Body: low-density polyethylene (LDPE), Tubing: thermoplastic elastomer (TPE)/polyvinyl chloride (PVC), Bag Interface: polyolefin elastomer (POE), Luer Taper: polypropylene (PP), Heparin Cap: acrylonitrile-butadiene-styrene (ABS), Liquid Clamps: Polyoxymethylene (POM), all conforming to USP Class VI standards

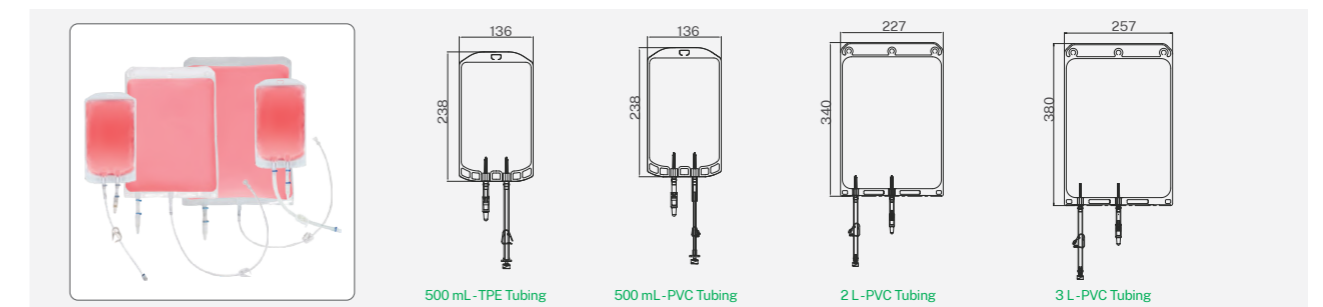

Features

- Medical-grade LDPE breathable membrane made, offering high permeability to O₂ and CO₂, beneficial to cell expansion culture
- Excellent optical clarity, allowing direct observation of cell morphology under a microscope
- Without bag replacement, media and cytokines can be added during the culture process, as well as sampling with closed systems
- The rounded, dead-angle-free bag body design combined with specially shaped inlet and outlet tubing ensures minimum collection residue
- Undergoes 100% integrity testing to guarantee excellent physical strength and sealing performance
- Two types of tubing are available: TPE (thick) and PVC (thin), with flexible customization options based on specific needs
- Individually packed, each packaging bag is printed with a batch number for quality traceability
- Sterilized by irradiation, SAL 10⁻⁶, DNase/RNase-free and non-cytotoxicity.

Cat. No.	Capacity			Surface Area (cm ²)	Tubing Specifications		Sterile	Packaging	
	Maximum	Standard Working	Working Range		Inlet/Outlet Tubing	Sampling Tubing		Qty. Pack	Qty. Case
CSP100500	500mL	250mL	50-500 mL	256	26 cm TPE thermoplastic tubing ID 6.35 mm × OD 9.53 mm, Luer female taper + plug	4.5 cm TPE thermoplastic tubing ID 6.35 mm × OD 9.53 mm, Luer female taper + heparin cap + silicone sleeve	Y	1	25
CSP101500	500mL	250mL	50-500 mL	256	26 cm PVC tubing ID 3.5 mm × OD 5.2 mm, Luer female taper + plug	4.5 cm PVC tubing ID 4.8 mm × OD 7.05 mm, Luer female taper + heparin cap + silicone sleeve	Y	1	25
CSP100020	2L	1L	200-2000 mL	635	50 cm PVC tubing ID 4.8 mm × OD 7.05 mm, Luer female taper + plug	4.5 cm PVC tubing ID 4.8 mm × OD 7.05 mm, Luer female taper + heparin cap + silicone sleeve	Y	1	25
CSP100030	3L	1.5L	300-3000 mL	822	50 cm PVC tubing ID 4.8 mm × OD 7.05 mm, Luer female taper + plug	4.5 cm PVC tubing ID 4.8 mm × OD 7.05 mm, Luer female taper + heparin cap + silicone sleeve	Y	1	25



Stock code: 688026

Storage and Transfer of Bioprocessing Fluid



During the process of scaling up from laboratory research to large-scale manufacturing, it is often necessary to transfer liquids between various culture containers, such as for media replenishment, sampling, and inoculation. Additionally, intermediate and final products from the culture process need to be collected, purified, and filled, which involves significant storage and transfer of process fluids.

Traditional open liquid transfer operations pose challenges such as inconvenience, time consumption, and contamination risks for researchers. On the other hand, closed stainless steel pipelines and containers are difficult to clean and offer limited flexibility. Hence, enclosed single-use liquid storage and transfer systems have become the preferred choice.

Jet Biofil has dedicated to research and development, introducing a range of products for storage and transfer of bioprocessing fluid, including single-use 2D storage bags and closed systems. All products are made from high-standard, medical-grade materials and undergo stringent testing by authoritative third-party institutions, including biosafety assessments, extractables studies, and insoluble particle testing. These products provide safe and reliable single-use solutions for bioprocessing fluid storage and transfer.

2D Single-Use Storage Bags

Storage bags are essential consumables for liquid preparation, storage and transportation in bioprocessing. Our 2D Single-Use Storage Bags are made from high-quality raw materials that ensure minimal gas permeability. The bags has excellent physical strength, chemical compatibility, and biocompatibility, making it ideal for safely storing and transferring various biopharmaceutical liquids with efficiency.

Our 2D Single-Use Storage Bags are subject to strict production and quality inspection control in strict accordance with the requirements of ISO 13485 and ISO 9001, and relevant GMP regulations are followed to ensure stable and reliable product quality. The size and tubing can be flexibly adjusted to fit various processes.



- Specification: 500mL 2-port 2L 3-port 3L 3-port 10L 3-port 20L 3-port 50L 3-port
- Membrane materials: External and domestic
- Materials: Bag body: multi-layer co-extruded films, Tubing: thermoplastic elastomer (TPE), Bag interface: polycarbonate (PC), Luer taper/MPC connector: polypropylene (PP)/polycarbonate (PC), all conforming to USP Class VI standards

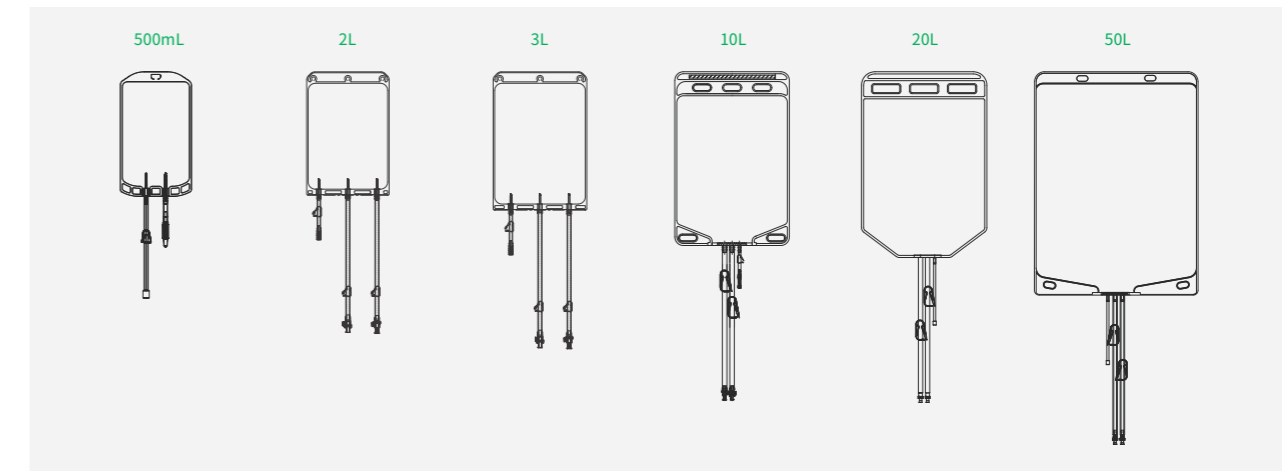

Features

- With good physical strength and broad chemical compatibility, applicable to various liquids in the biopharmaceutical process
- High transparency bags, facilitating auxiliary process judgment
- Adaptable to various mainstream transfer tools on the market
- Extremely low extractable levels and excellent biosafety, multiple assessments verified
- Operating temperature: from -80°C to 60°C
- Flexibly adjustable size and tubing to fit various processes
- Sterilized by irradiation, SAL 10⁻⁶, DNase/RNase-free, non-pyrogenic, human DNA-free

Cat. No.	Capacity	Membrane Material	Inlet/Outlet Tubings	Sampling Tubing	Sterile	Qty.Pack	Qty.Case	
CSP090500	500 mL	External membrane materials	26 cm TPE thermoplastic tubing ID 1/4" x OD 3/8", Luer male taper + Female plug	4.5 cm TPE thermoplastic tubing ID 1/4" x OD 3/8", needle sampling port + silicone sleeve	Y	5	25	
CSP091500		Domestic membrane materials			Y	5	25	
CSP090102	2 L	External membrane materials	50 cm TPE thermoplastic tubings ID 1/4" x OD 3/8", Male MPC Connector + Female Plug	50 cm TPE thermoplastic tubings ID 1/4" x OD 3/8", Female MPC Connector + Male Plug	10 cm TPE thermoplastic tubing ID 1/4" x OD 3/8", Female Luer One-way Sampling Port	Y	1	20
CSP091102		Domestic membrane materials				Y	1	20
CSP090003	3 L	External membrane materials	50 cm TPE thermoplastic tubings ID 1/4" x OD 3/8", Male MPC Connector + Female Plug	50 cm TPE thermoplastic tubings ID 1/4" x OD 3/8", Female MPC Connector + Male Plug	10 cm TPE thermoplastic tubing ID 1/4" x OD 3/8", Female Luer One-way Sampling Port	Y	1	20
CSP091003		Domestic membrane materials				Y	1	20
CSP090001	10 L	External membrane materials	50 cm TPE thermoplastic tubings ID 3/8" x OD 5/8", Male MPC Connector + Female Plug	50 cm TPE thermoplastic tubings ID 3/8" x OD 5/8", Female MPC Connector + Male Plug	10 cm TPE thermoplastic tubing ID 1/4" x OD 3/8", Female Luer One-way Sampling Port	Y	1	5
CSP091001		Domestic membrane materials				Y	1	5
CSP090002	20 L	External membrane materials	50 cm TPE thermoplastic tubings ID 3/8" x OD 5/8", Male MPC Connector + Female Plug	50 cm TPE thermoplastic tubings ID 3/8" x OD 5/8", Female MPC Connector + Male Plug	10 cm TPE thermoplastic tubing ID 1/4" x OD 3/8", Female Luer One-way Sampling Port	Y	1	5
CSP091002		Domestic membrane materials				Y	1	5
CSP090005	50 L	External membrane materials	50 cm TPE thermoplastic tubings ID 3/8" x OD 5/8", Male MPC Connector + Female Plug	50 cm TPE thermoplastic tubings ID 3/8" x OD 5/8", Female MPC Connector + Male Plug	10 cm TPE thermoplastic tubing ID 1/4" x OD 3/8", Female Luer One-way Sampling Port	Y	1	5
CSP091005		Domestic membrane materials				Y	1	5

For other specifications of bag sizes or tubes, please contact us for customized services.

Closed System for Erlenmeyer Flasks

In the industrial production of biological products, reducing the potential risk of contamination during processes such as liquid transfer and sampling is crucial. Pairing Erlenmeyer flasks with sterile transfer caps and tubing systems can effectively prevent contamination issues associated with open operations.



Jet Biofil has introduced a Closed System for large-capacity Erlenmeyer Flasks, made from USP Class VI-compliant materials, manufactured in GMP-standard cleanrooms. The system features extremely low extractable levels and excellent biosafety, making it suitable for fluid transfer processes during the research and production of biologics such as cell therapy, gene therapy, antibodies, and vaccines. After the transfer, the transfer cap can be replaced with ventilate cap to facilitate cell culture, which significantly reduces the risk of contamination and allows for easy, sterile, and secure liquid transfer.

- Specifications of matching erlenmeyer flask: 2 L, 3 L, and 5 L
- Types of tube connector: Male MPC connector and MLL connector
- Packaging: Three-layer outer medical packaging
- Materials: Bottle cap (PE) Inner tube (PTFE) Outer tube (TPE) MLL connector (PP)/MPC connector (PC) Filter housing (PP) Filter membrane(PTFE), conforming to USP Class VI standards

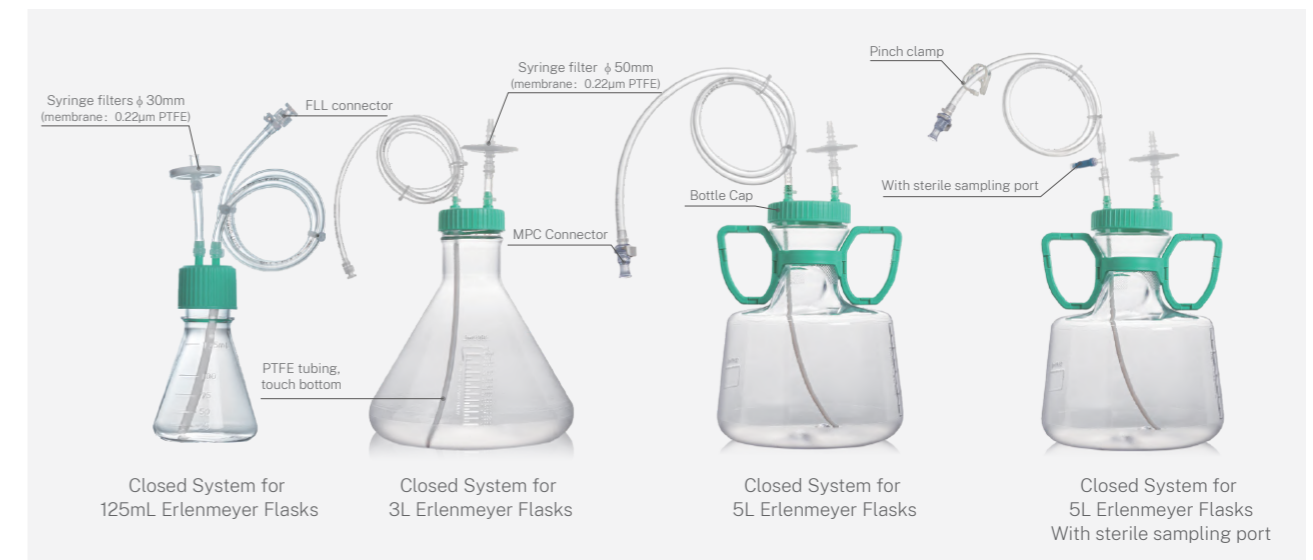

Features

- The closed transfer system can effectively reduce the risk of contamination in the process of liquid transfer
- The medical triple bagged package conforming to higher cleanliness requirement under the GMP production
- The bottle cap is connected by injection molding to reduce the risk of leakage and residue
- The length and aperture of the tube can also be customized
- Authoritative third-party inspected, products have extremely low extractable levels and excellent biosafety
- The inner tube can be extended to the bottom of the bottle to complete liquid transfer
- Male MPC connector and MLL connector are available to meet the different types of tube connections
- A three-way port for aseptic sampling is available in the 5L closed system, allowing safe and aseptic sampling
- Sterilized by irradiation, SAL 10⁻⁶
- DNase/RNase-free, Pyrogenic free, non-cytotoxic

Customization service

All Closed System Solutions can be customized accordingly

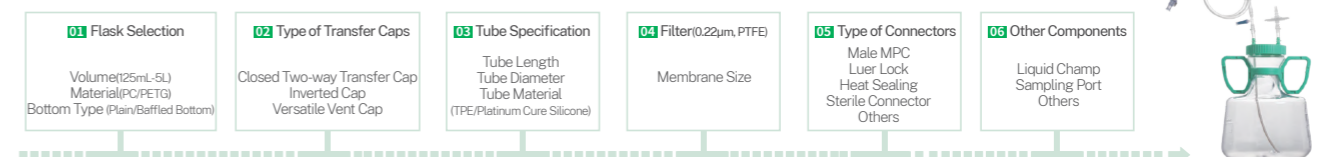

Cat. No.	Product Name	Tubing Specification			Filter	Sterile	Qty. Per/ Bag	Qty. Per/ Case
		Tubing Type	Tubing Dimension	Tubing Connector				
TAB300125	Closed System for 125 mL Culture Flasks	Two-port	60 cm, 1/8" ID, 1/4" OD	MLL	0.22 µm, PTFE, φ 30 mm	Y	1	4
TAB300250	Closed System for 250 mL Culture Flasks	Two-port	60 cm, 1/8" ID, 1/4" OD	MLL	0.22 µm, PTFE, φ 30 mm	Y	1	4
TAB300500	Closed System for 500 mL Culture Flasks	Two-port	60 cm, 1/8" ID, 1/4" OD	MLL	0.22 µm, PTFE, φ 50 mm	Y	1	4
TAB300000	Closed System for 1000 mL Culture Flasks	Two-port	60 cm, 1/8" ID, 1/4" OD	MLL	0.22 µm, PTFE, φ 50 mm	Y	1	4
TAB301000	Closed System for 1000 mL Culture Flasks	Two-port	60 cm, 1/4" ID, 3/8" OD	Male MPC	0.22 µm, PTFE, φ 50 mm	Y	1	4
TAB302000	Closed System for 1000 mL Culture Flasks	Two-port	60 cm, 1/4" ID, 7/16" OD	Heat-Sealing Port	0.22 µm, PTFE, φ 50 mm	Y	1	4
TAB300002	Sterile Transfer Cap of 2 L Culture Flasks	Two-port	120 cm, 1/4" ID, 3/8" OD	Male MPC	0.22 µm, PTFE, φ 50 mm	Y	1	6

Cat. No.	Product Name	Tubing Specification			Filter	Sterile	Qty. Per/ Bag	Qty. Per/ Case
		Tubing Type	Tubing Dimension	Tubing Connector				
TAB310002	Sterile Transfer Cap of 2 L Culture Flasks	Two-port	120 cm, 1/8" ID, 1/4" OD	MLL	0.22 µm, PTFE, φ 50 mm	Y	1	6
TAB331002	Sterile Transfer Cap of 2 L Culture Flasks	Two-port	50 cm, 1/4" ID, 7/16" OD	Heat-Sealing Port	0.22 µm, PTFE, φ 50 mm	Y	1	6
TAB300003	Sterile Transfer Cap of 3 L Culture Flasks	Two-port	120 cm, 1/4" ID, 3/8" OD	Male MPC	0.22 µm, PTFE, φ 50 mm	Y	1	6
TAB310003	Sterile Transfer Cap of 3 L Culture Flasks	Two-port	120 cm, 1/8" ID, 1/4" OD	MLL	0.22 µm, PTFE, φ 50 mm	Y	1	6
TAB331003	Sterile Transfer Cap of 3 L Culture Flasks	Two-port	50 cm, 1/4" ID, 7/16" OD	Heat-Sealing Port	0.22 µm, PTFE, φ 50 mm	Y	1	6
TAB311003	Sterile Transfer Cap of 3 L Culture Flasks	Two-port	50 cm, 1/8" ID, 1/4" OD	Heat-Sealing Port	0.22 µm, PTFE, φ 50 mm	Y	1	6
TAB321003	Sterile Transfer Cap of 3 L Culture Flasks	Two-port	120 cm, 1/4" ID, 3/8" OD	Heat-Sealing Port with Sterile Sampling Port	0.22 µm, PTFE, φ 50 mm	Y	1	6
TAB322003	Sterile Transfer Cap of 3 L Culture Flasks	Two-port	120 cm, 1/8" ID, 1/4" OD	Heat-Sealing Port with Sterile Sampling Port	0.22 µm, PTFE, φ 50 mm	Y	1	6
TAB300005	Sterile Transfer Cap of 5 L Culture Flasks	Two-port	100 cm, 1/4" ID, 3/8" OD	Male MPC with Sterile Sampling Port	0.22 µm, PTFE, φ 50 mm	Y	1	6
TAB320005	Sterile Transfer Cap of 5 L Culture Flasks	Two-port	100 cm, 1/4" ID, 3/8" OD	Male MPC	0.22 µm, PTFE, φ 50 mm	Y	1	6
TAB331005	Sterile Transfer Cap of 5 L Culture Flasks	Two-port	50 cm, 1/4" ID, 7/16" OD	Heat-Sealing Port	0.22 µm, PTFE, φ 50 mm	Y	1	6
TAB311005	Sterile Transfer Cap of 5 L Culture Flasks	Two-port	50 cm, 1/8" ID, 1/4" OD	Heat-Sealing Port	0.22 µm, PTFE, φ 50 mm	Y	1	6

MLL male Luer connector with plug; MPC male MPC connector with plug

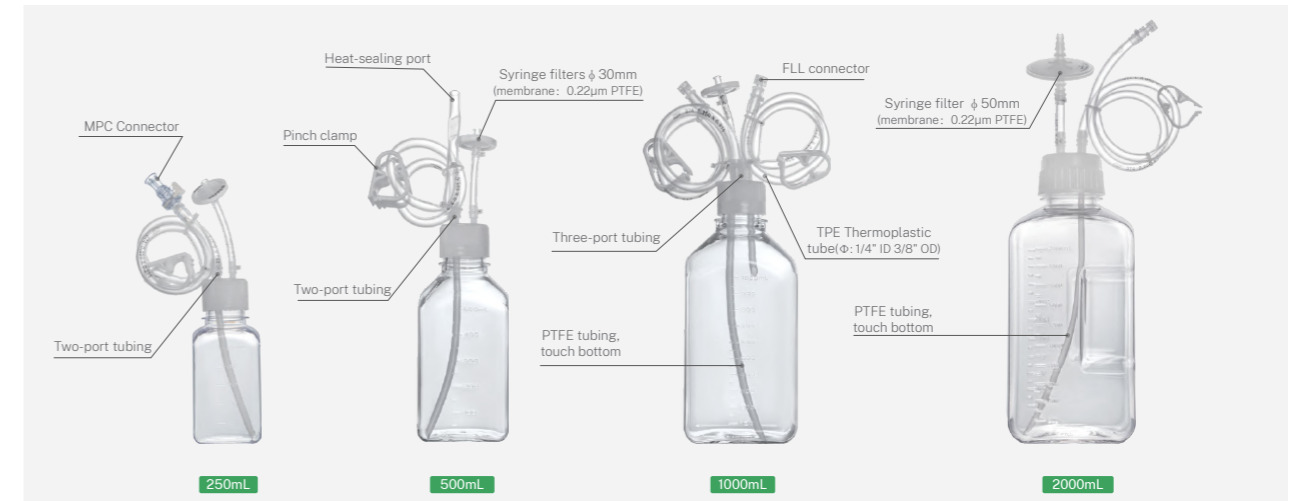

Features

- Crafted by materials comply with the USP Class VI standards with extremely low extractable levels and excellent biosafety
- Injection molded transfer cap combines pinch clamp on inlet/outlet tubing to reduce the risk of leaks and residue
- Inner tube can be extended to the bottom to ensure complete transfer
- 0.22µm PTFE syringe filter balances the internal and external pressure during liquid transfer while maintaining sterility
- Multiple tubing types and connectors are available to meet various pipeline connection requirements
- Working temperature range: from -80 C to 60 C
- Sterilized by irradiation, SAL 10⁻⁶; DNase/RNase-free, non-pyrogenic, non-cytotoxic

Customization service

All Closed System Solutions can be customized accordingly

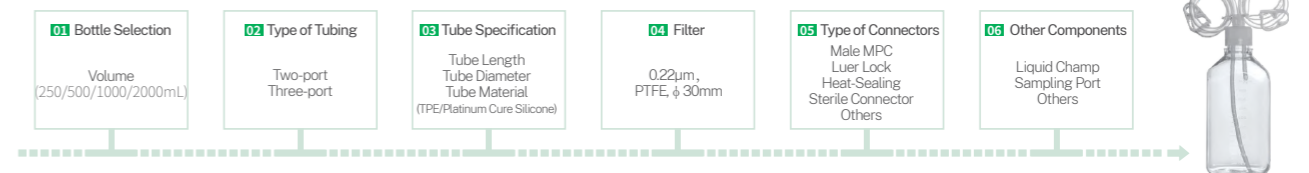

Cat. No.	Product Name	Tubing Specification			Filter	Sterile	Qty. Per/ Bag	Qty. Per/ Case
		Tubing Type	Tubing Dimension	Tubing Connector				
CSB010250	Closed System for 250mL Media Bottle	Two-port	60cm, 1/4" ID, 3/8" OD	FLL	0.22µm, PTFE, φ 30mm	Y	1	10
CSB011250	Closed System for 250mL Media Bottle	Two-port	60cm, 1/4" ID, 3/8" OD	Heat-Sealing Port	0.22µm, PTFE, φ 30mm	Y	1	10
CSB012250	Closed System for 250mL Media Bottle	Two-port	60cm, 1/4" ID, 3/8" OD	Male MPC	0.22µm, PTFE, φ 30mm	Y	1	10
CSB211250	Sterile Transfer Cap of 250mL Media Bottle	Two-port	60cm, 1/8" ID, 1/4" OD	Heat-Sealing Port	0.22µm, PTFE, φ 30mm	Y	1	10
CSB311250	Sterile Transfer Cap of 250mL Media Bottle	Two-port	60 cm, 1/4" ID, 7/16" OD	Heat-Sealing Port	0.22µm, PTFE, φ 30mm	Y	1	10
CSB020250	Sterile Transfer Cap of 250mL Media Bottle	Two-port	60cm, 1/4" ID, 3/8" OD	FLL	0.22µm, PTFE, φ 30mm	Y	1	10
CSB021250	Sterile Transfer Cap of 250mL Media Bottle	Two-port	60cm, 1/4" ID, 3/8" OD	Heat-Sealing Port	0.22µm, PTFE, φ 30mm	Y	1	10

Closed System for Media Bottles

In the industrial production of biological products, reducing the potential risk of contamination during processes such as liquid transfer and sampling is crucial. Pairing media bottles with sterile transfer caps and tubing systems can effectively prevent contamination issues associated with open operations.

Jet Biofil has introduced Closed System for media bottles, made from USP Class VI-compliant materials, manufactured in GMP-standard cleanrooms. Products have extremely low extractable levels and excellent biosafety, suitable for fluid supplementation and low-temperature storage during the processes of cell & gene therapy, antibody and vaccine biopharmaceutical R&D. They enable fully enclosed aseptic liquid transfer, minimizing contamination risk to the greatest extent.

- Specifications of matching media bottle: 250 mL, 500 mL, 1000 mL, and 2000 mL
- Types of tube connector: MPC connector, FLL connector, and Heat-sealing Port
- Specifications of matching tubing: Two-port Three-port
- Packaging: Double-layer outer medical packaging
- Materials: Bottle (PETG) Bottle cap (HDPE) Inner tube (PTFE) Outer thermoplastic tube (TPE) FLL connector (PP)/Male MPC connector (PC) Filter housing (PP) Filter membrane(PTFE), conforming to USP Class VI standards

Cat. No.	Product Name	Tubing Specification			Filter	Sterile	Qty. Per Bag	Qty. Per Case
		Tubing Type	Tubing Dimension	Tubing Connector				
CSB022250	Sterile Transfer Cap of 250mL Media Bottle	Two-port	60cm, 1/4" ID, 3/8" OD	Male MPC	0.22µm, PTFE, φ 30mm	Y	1	10
CSB110250	Closed System for 250mL Media Bottle	Three-port	60cm, 1/4" ID, 3/8" OD	FLL	0.22µm, PTFE, φ 30mm	Y	1	10
CSB111250	Closed System for 250mL Media Bottle	Three-port	60cm, 1/4" ID, 3/8" OD	Heat-Sealing Port	0.22µm, PTFE, φ 30mm	Y	1	10
CSB120250	Sterile Transfer Cap of 250mL Media Bottle	Three-port	60cm, 1/4" ID, 3/8" OD	FLL	0.22µm, PTFE, φ 30mm	Y	1	10
CSB121250	Sterile Transfer Cap of 250mL Media Bottle	Three-port	60cm, 1/4" ID, 3/8" OD	Heat-Sealing Port	0.22µm, PTFE, φ 30mm	Y	1	10
CSB010500	Closed System for 500mL Media Bottle	Two-port	60cm, 1/4" ID, 3/8" OD	FLL	0.22µm, PTFE, φ 30mm	Y	1	10
CSB011500	Closed System for 500mL Media Bottle	Two-port	60cm, 1/4" ID, 3/8" OD	Heat-Sealing Port	0.22µm, PTFE, φ 30mm	Y	1	10
CSB012500	Closed System for 500mL Media Bottle	Two-port	60cm, 1/4" ID, 3/8" OD	Male MPC	0.22µm, PTFE, φ 30mm	Y	1	10
CSB211500	Sterile Transfer Cap of 500mL Media Bottle	Two-port	60cm, 1/8" ID, 1/4" OD	Heat-Sealing Port	0.22µm, PTFE, φ 30mm	Y	1	10
CSB013500	Closed System for 500 mL Media Bottle	Two-port	60 cm, 1/4" ID, 7/16" OD	Heat-Sealing Port	0.22µm, PTFE, φ 30mm	Y	1	10
CSB020500	Sterile Transfer Cap of 500mL Media Bottle	Two-port	60cm, 1/4" ID, 3/8" OD	FLL	0.22µm, PTFE, φ 30mm	Y	1	10
CSB021500	Sterile Transfer Cap of 500mL Media Bottle	Two-port	60cm, 1/4" ID, 3/8" OD	Heat-Sealing Port	0.22µm, PTFE, φ 30mm	Y	1	10
CSB022500	Sterile Transfer Cap of 500mL Media Bottle	Two-port	60cm, 1/4" ID, 3/8" OD	Male MPC	0.22µm, PTFE, φ 30mm	Y	1	10
CSB110500	Closed System for 500mL Media Bottle	Three-port	60cm, 1/4" ID, 3/8" OD	FLL	0.22µm, PTFE, φ 30mm	Y	1	10
CSB111500	Closed System for 500mL Media Bottle	Three-port	60cm, 1/4" ID, 3/8" OD	Heat-Sealing Port	0.22µm, PTFE, φ 30mm	Y	1	10
CSB120500	Sterile Transfer Cap of 500mL Media Bottle	Three-port	60cm, 1/4" ID, 3/8" OD	FLL	0.22µm, PTFE, φ 30mm	Y	1	10
CSB121500	Sterile Transfer Cap of 500mL Media Bottle	Three-port	60cm, 1/4" ID, 3/8" OD	Heat-Sealing Port	0.22µm, PTFE, φ 30mm	Y	1	10
CSB010001	Closed System for 1000mL Media Bottle	Two-port	60cm, 1/4" ID, 3/8" OD	FLL	0.22µm, PTFE, φ 30mm	Y	1	10
CSB011001	Closed System for 1000mL Media Bottle	Two-port	60cm, 1/4" ID, 3/8" OD	Heat-Sealing Port	0.22µm, PTFE, φ 30mm	Y	1	10
CSB012001	Closed System for 1000mL Media Bottle	Two-port	60cm, 1/4" ID, 3/8" OD	Male MPC	0.22µm, PTFE, φ 30mm	Y	1	10
CSB211001	Closed System for 1000mL Media Bottle	Two-port	60cm, 1/8" ID, 1/4" OD	Heat-Sealing Port	0.22µm, PTFE, φ 30mm	Y	1	10
CSB311001	Closed System for 1000mL Media Bottle	Two-port	60cm, 1/8" ID, 1/4" OD	FLL	0.22µm, PTFE, φ 30mm	Y	1	10
CSB511001	Closed System for 1000 mL Media Bottle	Two-port	60 cm, 1/4" ID, 7/16" OD	Heat-Sealing Port	0.22µm, PTFE, φ 30mm	Y	1	10
CSB020001	Sterile Transfer Cap of 1000mL Media Bottle	Two-port	60cm, 1/4" ID, 3/8" OD	FLL	0.22µm, PTFE, φ 30mm	Y	1	10
CSB021001	Sterile Transfer Cap of 1000mL Media Bottle	Two-port	60cm, 1/4" ID, 3/8" OD	Heat-Sealing Port	0.22µm, PTFE, φ 30mm	Y	1	10
CSB022001	Sterile Transfer Cap of 1000mL Media Bottle	Two-port	60cm, 1/4" ID, 3/8" OD	Male MPC	0.22µm, PTFE, φ 30mm	Y	1	10

Cat. No.	Product Name	Tubing Specification			Filter	Sterile	Qty. Per Bag	Qty. Per Case
		Tubing Type	Tubing Dimension	Tubing Connector				
CSB110001	Closed System for 1000mL Media Bottle	Three-port	60cm, 1/4" ID, 3/8" OD	FLL	0.22µm, PTFE, φ 30mm	Y	1	10
CSB111001	Closed System for 1000mL Media Bottle	Three-port	60cm, 1/4" ID, 3/8" OD	Heat-Sealing Port	0.22µm, PTFE, φ 30mm	Y	1	10
CSB120001	Sterile Transfer Cap of 1000mL Media Bottle	Three-port	60cm, 1/4" ID, 3/8" OD	FLL	0.22µm, PTFE, φ 30mm	Y	1	10
CSB121001	Sterile Transfer Cap of 1000mL Media Bottle	Three-port	60cm, 1/4" ID, 3/8" OD	Heat-Sealing Port	0.22µm, PTFE, φ 30mm	Y	1	10
CSB010002	Closed System for 2000mL Media Bottle	Two-port	60cm, 1/4" ID, 3/8" OD	FLL	0.22µm, PTFE, φ 50mm	Y	1	6
CSB011002	Closed System for 2000mL Media Bottle	Two-port	60cm, 1/4" ID, 3/8" OD	Heat-Sealing Port	0.22µm, PTFE, φ 50mm	Y	1	6
CSB012002	Closed System for 2000mL Media Bottle	Two-port	60cm, 1/4" ID, 3/8" OD	Male MPC	0.22µm, PTFE, φ 50mm	Y	1	6
CSB014002	Closed System for 2000mL Media Bottle	Two-port	60cm, 1/8" ID, 1/4" OD	Heat-Sealing Port	0.22µm, PTFE, φ 50mm	Y	1	6
CSB020002	Sterile Transfer Cap of 2000mL Media Bottle	Two-port	60cm, 1/4" ID, 3/8" OD	FLL	0.22µm, PTFE, φ 50mm	Y	1	6
CSB021002	Sterile Transfer Cap of 2000mL Media Bottle	Three-port	60cm, 1/4" ID, 3/8" OD	Heat-Sealing Port	0.22µm, PTFE, φ 50mm	Y	1	6
CSB022002	Sterile Transfer Cap of 2000mL Media Bottle	Three-port	60cm, 1/4" ID, 3/8" OD	Male MPC	0.22µm, PTFE, φ 50mm	Y	1	6
CSB013002	Closed System for 2000mL Media Bottle	Three-port	60cm, 1/4" ID, 3/8" OD	Heat-Sealing Port	0.22µm, PTFE, φ 50mm	Y	1	6

Closed System for Centrifuge Tubes/Bottles

In the industrial production of biological products, reducing the potential risk of contamination during processes such as liquid transfer and sampling is crucial. Pairing centrifuge tubes with sterile transfer caps and tubing systems can effectively prevent contamination issues associated with open operations.

Jet Biofil has introduced a Closed System for Centrifuge Tubes/Bottles, made from USP Class VI-compliant materials, manufactured in GMP-standard cleanrooms, and subjected to rigorous tests including extractables studies and biocompatibility assessments. These systems are suitable for enclosed sampling and aseptic liquid transfer in bioprocessing. It comes with double-layer packaging, and each system is equipped with a separately packaged plug seal cap, which can be replaced for supporting subsequent operations, such as centrifugation and testing.

- Specifications of matching tubes/bottles: 50 mL, 250 mL, and 500 mL
- Type of tube connector: MLL connector
- Specifications of matching tubing: Two-port
- Packaging: Double-layer outer medical packaging
- Material: Bottle cap (HDPE) Inner tube (PTFE) Outer thermoplastic tube (TPE) MLL connector (PP) Filter housing (PP) Filter membrane (PTFE), conforming to USP Class VI standards

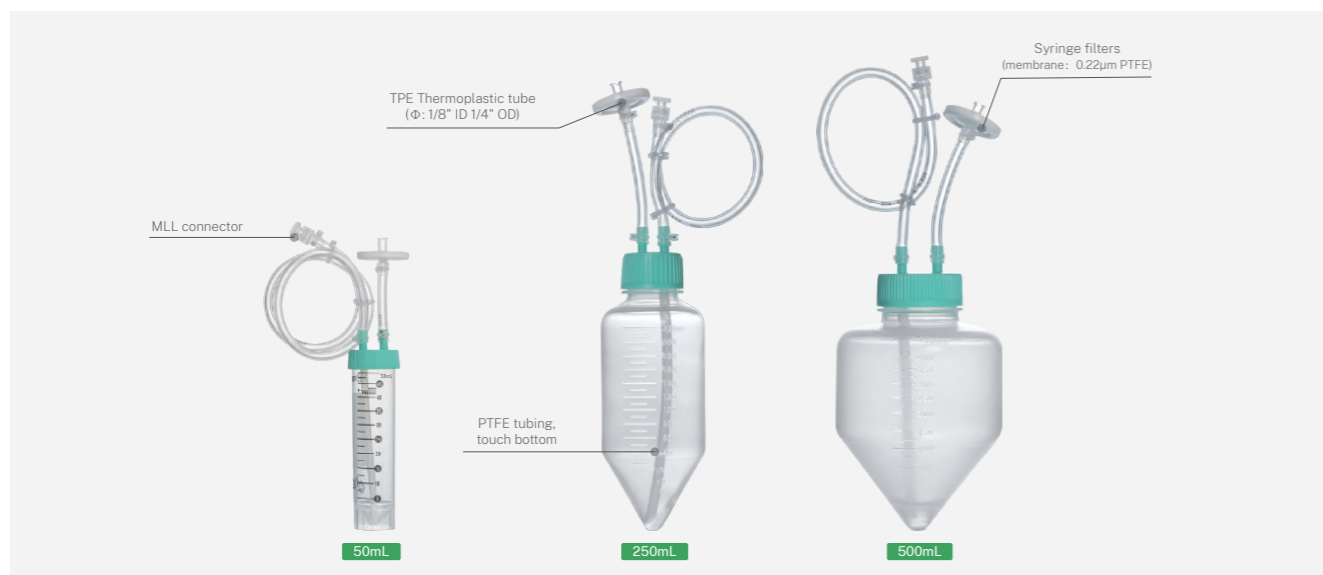

Stock Code: 688026

Bioprocess Filtration



Features

- Raw materials compliant with USP Class VI standards, products feature extremely low extractable levels and excellent biosafety
- Injection molded bottle cap sharply decrease leakage and residue
- Inner tube can be extended to the bottom to ensure complete transfer
- 0.22µm PTFE syringe filter balances the internal and external pressure during liquid transfer while maintaining sterility
- Separately packaged plug seal cap can be replaced for supporting subsequent operations, such as centrifugation and testing
- Tubing length and diameter can be customized according to specific needs
- Working temperature range: -80-60 C
- Sterilized by irradiation, SAL 10⁻⁶; DNase/RNase-free, non-pyrogenic, non-cytotoxic

Customization service

Jet Biofil offers an extensive library of fully validated components including vessels, filters, connectors, tubing, clamps, and plugs making it easy to design a customized closed system solution for your specific application



Cat. No.	Product Name	Tubing Specification			Filter	Sterile	Packaging		
		Tubing Type	Tubing Dimension	Tubing Connector			Extra Component	Qty. Per Bag	Qty. Per Case
CST010050	Closed System for 50 mL Centrifuge Tube (Self-standing)	Two-port	50cm, 1/8" ID, 1/4" OD	MLL	0.22µm, PTFE, φ 30mm	Y	Each closed system comes with a plug seal cap for replacement	1	4
CST010250	Closed System for 250mL Conical Bottle	Two-port	50cm, 1/8" ID, 1/4" OD	MLL	0.22µm, PTFE, φ 30mm	Y		1	4
CST010500	Closed System for 500mL Conical Bottle	Two-port	50cm, 1/8" ID, 1/4" OD	MLL	0.22µm, PTFE, φ 30mm	Y		1	4

MLL male Luer connector with plug

In recent years, drug regulatory authorities have issued various regulations and guidelines in the biopharmaceutical field, specifying requirements for production-related equipment, consumables, packaging, and sealing systems to ensure the safety and efficacy of biologics in clinical use. Bioprocess filtration consumables for pre-filtration, sterilizing filtration, viral filtration, and ultrafiltration are critical components in biopharmaceutical processes and play an essential role in bioburden control.

For bioprocess filtration products, Jet Biofil has conducted extensive research from membrane materials to finished products, and introduces a range of high-performance membrane materials and their derivative products over the years, including the PES membranes series, the Nitrocellulose membranes, the Pureflow™ Capsule Sterilizing Filters and the Ultrafiltration modules Cassettes. Final products feature extremely low extractable levels and high biosafety, effectively cope with filtration and purification needs of upstream and downstream bioprocess fluids.

PureFlow™ Capsule Sterilizing Filters

Capsule sterilizing filters are primarily used for the aseptic liquid filtration of cell culture media, buffer solutions, intermediate solutions, stock solutions, and semi-finished products in processes of biopharmaceuticals. They serve as critical consumables for aseptic liquid filtration and bioburden control in biopharmaceutical processes.

Jet Biofil's PureFlow™ Capsule Sterilizing Filters are ready-to-use filtration device made with premium double-layer hydrophilic asymmetric PES membranes. With pore sizes of 0.45µm and 0.22µm, the product effectively prevents early-stage clogging, sharply retains bacteria and particles, and achieves aseptic filtration. Product's integrated design ensures ease of operation, offering excellent flow rates, large volume capacity, broad chemical compatibility, and excellent biocompatibility, to finally lessen bioburdens and boost bioprocess efficiency.

- Specification: D Series L Series 2.0" L Series 5.0" L Series 10.0"
- Materials: Filter Membrane: Polyethersulfone (PES), Filter Membrane Protective Layer: Polypropylene (PP), Capsule Housing: Polypropylene (PP), Filter Membrane Protective Layer: Polypropylene (PP), Gasket O-ring : Silicone, conforming to USP Class VI standards



Connector combination options (customized services available upon request)

Features

- Selected hydrophilic PES membranes with low protein adsorption ensure fast flow rates and high throughput
- Double-layer asymmetric PES membrane for capable dirt-holding capacity and high throughput
- Reliable bacterial and particulate retention capacity
- Multiple connection options available, allowing for linear scale-up from R&D to process scale
- Excellent biocompatibility and broad chemical compatibility (pH 1-14)
- Ultra-low extractable levels and without fiber shedding, avoiding contamination of fluids
- Undergone 100% filter integrity assessment

Parameters

PureFlow™ Capsule Sterilizing Filters				
Technical Specification	D Series	L Series 2.0"	L Series 5.0"	L Series 10.0"
Filtering Area (m ²)	0.03	0.1	0.2	0.4
Connection	Multi Stepped Hose Barb	3/8" Single Stepped Hose Barb	1" Sanitary Flange	
Pore Size	0.45 µm + 0.22 µm			

Dimensions				
Height (mm)	122±2	152±2	207±3	340±3
Outer Diameter (mm)	64±0.5	78±1	78±1	78±1
Operating Characteristics				
Maximum Operating Pressure	4.0 bar (25°C) 2.0 bar (50°C)	5.5 bar(25°C) / 3.0 bar(50°C) / 1.0 bar(80°C)		
Maximum Reverse Operating Pressure	2.0 bar (25°C)			
Integrity Testing	Leakage-Free at 4.0 bar	Leakage-Free at 5.5 bar		
Maximum Operating Temperature	80 C			
Verification Assessment				
Maximum Diffusive Flow (mL/min)@2.5 bar	3.0	6.0	11.0	20.0
Water Throughput (L/min)@0.3 bar (25 C)	1.8	6.2	12.5	25
Bubble Point (25 C, water)	0.2 µm≥3.7bar			
Bacterial Retention	Passed 10 ⁷ CFU/cm ² Brevundimonas diminuta (ATCC 19146) retention test according to ASTM 838-05 test method			
Biological Compatibility	Passed biological compatibility tests based on USP <87> and USP <88>			
Endotoxin	Complies with USP <85>, with an endotoxin content of <0.25 EU/mL			
Fiber Releasing	Complies with "nonfiber releasing" criteria in FDA 21 CFR 210.3 (b) (6)			
Insoluble Particle	Complies with USP <788> Particulate Matter in Injections			
TOC/Conductivity	Complies with USP <645> Conductivity and USP <643> Total Organic Carbon			
Oxidizable Substances	Complies with USP-NF2024 Oxidizable Substances Test requirements			
Recommended Sterilization Parameters				
SAL	After electron beam irradiation, SAL 10 ⁻⁶			
Sterilization Method & Thermal Stability	25-40 kGy electron beam irradiation (EB) pre-sterilized, resist against 3 cycles of autoclaving at 126°C for 60 minutes			
Shell Life	3 Years			

Cat. No.	Size	Effective Filtration Area (m ²)	Membrane Material	Membrane Pore Size	Connection (Inlet/Outlet)	Sterile	Qty. Per Box	Qty. Per Case
LFD124303	D Series	0.03	PES	0.2µm+0.45µm	1/4" Multi Stepped Hose Barb- 1/4" Multi Stepped Hose Barb	Y	5	20
LFL124002	2"	0.10	PES	0.2µm+0.45µm	1" Sanitary Flange-3/8" Single Stepped Hose Barb	Y	1	4
LFL124102	2"	0.10	PES	0.2µm+0.45µm	1" Sanitary Flange-1" Sanitary Flange	Y	1	4
LFL124202	2"	0.10	PES	0.2µm+0.45µm	3/8" Single Stepped Hose Barb- 3/8" Single Stepped Hose Barb	Y	1	4
LFL124005	5"	0.20	PES	0.2µm+0.45µm	1" Sanitary Flange-3/8" Single Stepped Hose Barb	Y	1	4
LFL124105	5"	0.20	PES	0.2µm+0.45µm	1" Sanitary Flange-1" Sanitary Flange	Y	1	4
LFL124205	5"	0.20	PES	0.2µm+0.45µm	3/8" Single Stepped Hose Barb- 3/8" Single Stepped Hose Barb	Y	1	4
LFL124010	10"	0.40	PES	0.2µm+0.45µm	1" Sanitary Flange-3/8" Single Stepped Hose Barb	Y	1	4
LFL124110	10"	0.40	PES	0.2µm+0.45µm	1" Sanitary Flange-1" Sanitary Flange	Y	1	4
LFL124210	10"	0.40	PES	0.2µm+0.45µm	3/8" Single Stepped Hose Barb- 3/8" Single Stepped Hose Barb	Y	1	4

Shelf Life: 3 years in dry place under room temperature



Stock Code: 688026

High-performance Membrane Materials

Biomedical membranes are core raw materials in the biopharmaceutical field. Focusing on this key technology, Jet Biofil has been dedicated to advancing biomedical membrane development, successfully introducing a range of high-performance membrane materials in various compositions, including PES, NC, and PVDF membranes, which are widely applicable in the biopharmaceutical industry.



Stock Code: 688026

In Vitro Fertilization (IVF) Products

Specialized Consumables for Assisted Reproduction (Medical Device)



In vitro fertilization (IVF) refers to the process of taking sperm and eggs out of the body and completing the fertilization process in an artificially controlled environment. The early embryos cultured in vitro can be implanted into the human body, giving birth to new life.

IVF technology involves many details, and the entire process requires a significant investment of time, effort, and financial resources. The choice of consumables used in the IVF process is a crucial aspect with strict product quality requirements.

Jet Biofil's Specialized Consumables for Assisted Reproduction are designed to provide safe and reliable products for complex IVF applications. Through rigorous testing, including authoritative third-party biocompatibility inspection, in vitro mouse embryo experiments, and human sperm survival tests, ensuring the vitality of human reproductive cells and embryos throughout the complex processes of preparation, storage, operation, cultivation, and transfer in an in vitro environment. All products strictly adhere to ISO 13485 for rigorous production and quality control, also following the GMP manufacturing requirements to ensure even more stable and reliable product quality.

PES Ultrafiltration Membranes

PES ultrafiltration membrane is a high-performance filtration consumable. Featuring a precise microporous structure, it serves as a filtration medium for product extraction, separation, and concentration through physical pressurization. Jet Biofil's PES Ultrafiltration Membranes are crafted from hydrophilic PES material with low protein adsorption, utilizing an asymmetric composite nanostructure design. These membranes offer strong anti-fouling capabilities, reduced clogging risks, fast flow rates, and high throughput, making them ideal for handling biopharmaceutical samples such as blood products, vaccines, and monoclonal antibodies.

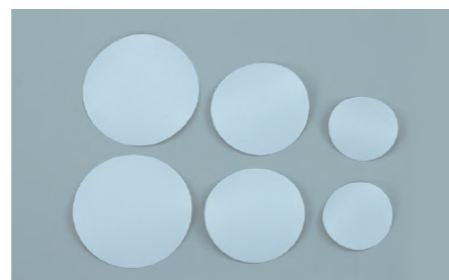

- Diameter: 44.5 mm 63.5 mm 76 mm
- Material: Polyethersulfone (PES)
- Molecular weights cutoff (MWCO): 3kDa 5kDa 10kDa 30kDa 50kDa 100kDa 300kDa

Diameter/Packaging	MWCO	3kDa	5kDa	10kDa	30kDa	50kDa	100kDa	300kDa
44.5mm/20pk		UFM003044	UFM005044	UFM010044	UFM030044	UFM050044	UFM100044	UFM300044
63.5mm/10pk		UFM003063	UFM005063	UFM010063	UFM030063	UFM050063	UFM100063	UFM300063
76mm/10pk		UFM003076	UFM005076	UFM010076	UFM030076	UFM050076	UFM100076	UFM300076

Specialized Consumables for Assisted Reproduction (Medical Device)

Registration Certificate No.: GDMDR 20232181838

In vitro fertilization (IVF) refers to the process of taking sperm and eggs out of the body and fertilizing egg with sperm in vitro in an artificially controlled environment. JET BIOFIL specialized consumables for assisted reproduction are designed to provide safe and reliable products for complex IVF and other assisted reproductive applications. These consumables undergo rigorous third-party testing, including biocompatibility, in vitro mouse embryo, and human sperm survival tests to ensure that human germ cells and embryos remain viable throughout the process of preparation, storage, operation, culture, and transfer in an in vitro environment.

- Specification: Center-well Culture Dish, 35/60/90 mm Culture Dish (Flat Bottom), Four-well Culture Plate
- Material: polystyrene (PS), conforming to USP Class VI standards



Features

- Selecting medical-grade polystyrene as the preferred raw material for its highly transparent surface that facilitates the observation of eggs and embryos
- Smooth and thin bottom design for efficient heat transfer and constant temperature and pH
- Designed lid to facilitate aseptic operation and maintain a stable environment for embryo culture over long periods
- Gear ring design on the dish side for easy hold and use to effectively reduce the risk of contamination
- Surface without TC treatment for optimum consistency of media droplets
- Conducting rigorous third-party testing to ensure non-embryotoxic, non-pyrogenic, non-cytotoxic, non-genotoxic, or non-mutagenic
- Implementing strict production and quality testing controls as per ISO 13485 and relevant GMP requirements to ensure stable and reliable product quality
- Sterilized by irradiation, SAL 10⁶

1



IVF-Specialized Center-well Culture Dish

- ◇ Size: 50.4×13.8 mm (dish); 21×14 mm (well)
- ◇ Purpose: Thawing frozen embryos to restore their biological activity; in vitro culture of embryos

2



IVF-Specialized 35 mm Culture Dish

- ◇ Size: 33×10.5 mm (dish); 36×6 mm (lid)
- ◇ Purpose: Droplet culture of embryos

3



IVF-Specialized 60 mm Culture Dish

- ◇ Size: 52.5×15 mm (dish); 55.5×6 mm (lid)
- ◇ Purpose: Egg collection, washing, and digestion of granular cells outside the egg; embryo freezing/thawing

4



IVF-Specialized 90 mm Culture Dish

- ◇ Size: 85×14.5 mm (dish); 89×8 mm (lid)
- ◇ Purpose: Egg collection, washing, and digestion of granular cells outside the egg

5



IVF-Specialized Four-well Culture Plate

- ◇ Size: 16×12 mm (single well)
- ◇ Purpose: Freezing and recovery of embryos and in vitro culture of embryos

Cat. No.	Model	Description	Surface Type	Sterile	Qty. Per Bag (Box)	Qty./Case
IVF050060	Center-well	IVF-Specialized Center-well Culture Dish	Non-treated	Y	10	600
IVF050035	35 mm, Flat bottom	IVF-Specialized 35 mm Culture Dish	Non-treated	Y	10	960
IVF051060	60 mm, Flat bottom	IVF-Specialized 60 mm Culture Dish	Non-treated	Y	10	600
IVF050090	90 mm, Flat bottom	IVF-Specialized 90 mm Culture Dish	Non-treated	Y	10	500
IVF041004	Four-well plate	IVF-Specialized Four-well Culture Plate	Non-treated	Y	1	100

Disposable Virus Sampling Tubes (Medical Device)

A disposable virus sampling tube is composed of a throat swab and a tube containing preservation solution. It can be used for sampling, transportation and storage of virus samples. The disposable virus sampling tube of Jet Bio-Filtration Co., Ltd. complies with the "Technical Specifications for Detection of 2019-nCoV Nucleic Acids with 10 in 1 Mixed Collection" and "Technical Specifications for Detection of 2019-nCoV Nucleic Acids with 20-in-1 Mixed Collection", and is suitable for large-scale 2019-nCoV screening.

[Medical Device Registration Certificate No./Product Technical Requirements No.]: YSXB No. 20201245

[Medical Device Production Registration Certificate No.]: YSSYJXSCB No. 20200254

- Specification: 10 Samples in 1 Tube, 20 Samples in 1 Tube
- Packaging: Box, Carton
- Materials: Tube Body: Polypropylene (PP) Tube Cap: High-Density Polyethylene(PE)



Disposable sampling tube

- Made of high-quality polypropylene (PP), the tube body is transparent with no scale, has good visibility, and can stand on the bottom
- It is designed with a conical bottom so that it is easy to pour and minimizes residue
- Spiral seal with a unique structural design and manufacturing process prevents liquid leakage
- The size complies with the Technical Specifications for Detection of 2019-nCoV With Mixed Collection

Preservation solution

- Purple preservation solution for easy observation and identification
- Inactivated type without guanidine salt effectively preserves RNA and protects medical personnel
- No RNA ase, no DNA ase and no endotoxin
- Transport and store at room temperature; the pH value of the sample preservation solution is 9 ± 0.5 at 25°C

Sampling throat swab

- The high-quality flocked swab facilitates rapid sampling and release
- The disposable throat swab is easy to handle and break with no debris

Storage conditions : Store indoors; Shelf life: 18 months

Sample storage: 3 days at 37°C, 1 week at 25°C, 1 month at 4°C, long-term storage below -20°C

Cat. No.	Product Description	Package
CY1003010	10 mL sampling tube (10-in-1 standard tube) + 6 mL preservation solution, sterile	50 Pcs/Box, 24box/Carton
CY1002010	10 mL sampling tube (10-in-1 standard tube) + 6 mL preservation solution, sterile; Sampling throat swab, non-sterile	50 Pcs/Box, 1200 Pcs/Carton
CY1003030	30 mL sampling tube (20-in-1 standard tube) + 11-12 mL preservation solution, sterile	20 Pcs/Box, 24 Box/Carton
CYS001001	Sampling throat swab	50 Pcs/Box, 9600 Pcs/carton
CYS001002	Sampling throat swab	100 Pcs/Box, 6000 Pcs/carton
CYS011001	Sampling throat swab (Single Packed)	100 Pcs/Bag, 500 Pcs/Box, 2000 Pcs/Carton



Stock Code: 688026

Biological Reagents



In addition to laboratory consumables, Jet Biofil is committed to providing customers with a series of reliable, high-quality biological reagents. The ProGro™ biological reagent series includes fetal bovine serum, serum-free media, classical media, and various supplementary reagents. All reagent products have undergone years of formulation refinement and improvement and are aseptically filled in GMP cleanrooms. Each batch undergoes stringent quality testing to ensure stable performance, providing an optimal environment for cell growth and protein/virus production.

Fetal Bovine Serum

Fetal Bovine Serum (FBS) is a light yellow, clear, non-hemolytic, foreign body-free, slightly viscous liquid. It is commonly added to cell culture media to promote and maintain the growth of cells of vertebrates, mammals, insects and other species. The FBS produced by Jet Bio-Filtration Co., Ltd is prepared from the blood of 8-month-old fetal calves of healthy pregnant cows, which is aseptically collected, separated and filtered. The product has high nutrient content, no mycoplasma, no bovine virus and no bacteriophage, and an endotoxin content less than 1 EU/mL. It is suitable for cell, tissue and organ culture, cell line preservation, and monoclonal antibody development, and is one of the preferred media used by hospitals, scientific research institutions, and vaccine and biopharmaceutical manufacturers.



- ◉ Blood origin: Uruguay, China
- ◉ Origin: Guangzhou China
- ◉ Specifications: 100 mL, 500 mL
- ◉ Storage conditions: -15°C – 20°C
- ◉ Shelf life: 5 years

Features

- ◉ The FBS of Jet Bio-Filtration Co., Ltd. is produced with strictly screened raw materials from selected high-quality, nationally approved blood origins in the world (Uruguay and China)
- ◉ The blood source is stable without cattle disease epidemic within 2 years. The source of serum is traceable, including the health of the mother cow.
- ◉ Strictly controlled production environment: standard cleanrooms, filling in Class 100 local clean environments, low temperature control system.
- ◉ International advanced production technology and 0.1 μm filtration three times help achieve stable product performance and little difference between batches.
- ◉ With complete test indexes, the product has high nutrient content, no mycoplasma, no bovine virus, no bacteriophage, and an endotoxin content less than 1 EU/mL.

Confirmation Projects

Project	Quality Standard	Test Result	Project	Quality Standard	Test Result
Appearance	Light yellow, clear and transparent	Light yellow, clear and transparent	Sterility test	Negative	Negative
PH value	7.00-8.50	7.97	Mycoplasma	Negative	Negative
Protein content (g/L)	30-40	38.7	Coliphage	Negative	Negative
Endotoxin (Eu/ml)	≤5	≤5	Maximum proliferative concentration	≥10 ⁶ /ml	1.6x10 ⁶ /ml
Hemoglobin (ml/L)	≤200	140.4	Cell doubling time	Not more than 20h	17.8h
Osmotic pressure (mOs mol/kg)	250-330	287	Cell cloning rate	Not less than 70%	83.50%

Viral Testing

All virus test results should be negative	Bovine diarrhoea virus (BVDV)	Bovine adenovirus (BAV-3)	Bovine parvovirus (BPV)	Reovirus (REO-3)	Bovine parainfluenza virus (PI-3)
	Negative	Negative	Negative	Negative	Negative
Storage conditions and validity period	-15°C to -20°C; valid for 5 years from the date of production.				

Cat. No.	Description	Volume (mL)	Pcs/Carton
FBS111025	Imported fetal bovine serum	25	50
FBS110100		100	50
FBS111500		500	20
FBS100025	Domestic fetal bovine serum	25	84
FBS100100		100	84
FBS101500		500	20
FBS130100	Imported newborn bovine serum	100	50
FBS131500		500	20

Media

A variety of different liquid cell culture mediums are provided by Jet Bio-Filtration Co., Ltd. to meet the needs of daily experiments.



RPMI-1640 culture liquid RPM101640

It is currently a widely used medium in the culture of mammalian and special hematopoietic cells, normal or malignant hyperplastic leukocytes and hybridoma cells. It is mainly used for suspension cell culture.

* [+]2.0 g/L Glucose [+]2.0 g/L NaHCO₃ [+]3.0 g/L HEPEs [+]2 mM L-Glutamine

* 500 mL/bottle, 20 bottles/carton

* Storage conditions: 2-8°C

DMEM high glucose DME101500

It is a widely used medium that can be used for many mammalian cell cultures and is more suitable for high-density suspension cell culture. It is suitable for the culture of clones with poor adhesion in which detachment from the original growth point is not desired. and can also be used for culturing hybridoma cells and DNA transfected transformed cells.

* [+]4.5 g/L Glucose [+]2.5 g/L NaHCO₃ [+]0.11 g/L Sodium Pyruvete [+]3.0 g/L HEPEs [+]2 mM L-Glutamine

* 500 mL/bottle, 20 bottles/carton

* Storage conditions: 2-8°C

DMEM low glucose DME102500

It is a widely used medium for many mammalian cell cultures. Low glucose medium is suitable for anchorage-dependent cell culture, especially for tumor cell culture with fast growth rate and poor adhesion.

* [+] 1.0 g/L Glucose [+] 2.5 g/L NaHCO_3 [+] 0.11 g/L Sodium Pyruvate [+] 3.0 g/L HEPEs [+] 2 mM L-Glutamine

* 500 mL/bottle , 20 bottles/carton

* Storage conditions: $2-8^\circ\text{C}$

DMEM/F12 DME103500

F12 medium has a complex composition and contains a variety of trace elements. It is combined with DMEM in a 1:1 ratio to form the DMEM/F12 Medium. As the basis for the development of a serum-free formula, it is suitable for mammalian cell culture under low-serum conditions by taking advantage of the richer ingredients in F12 and the higher concentration of nutrients in DMEM. At present, DMEM/F12 is widely used in the basal culture of MDCK cells, neurogliaocytes, fibroblasts, endothelial cells, rat fibroblasts and many other mammalian cells. At the same time, this medium is very suitable for clonal density culture, and has been widely used in the study of the effects of various hormones and growth factors in target tissues.

* [+] 3.15 g/L Glucose [+] $\text{Pyridoxine Hydrochloride}$ [+] 1.2 g/L NaHCO_3 [+] 3.0 g/L HEPEs [+] 2 mM L-Glutamine

* 500 mL/bottle , 20 bottles/carton

* Storage conditions: $2-8^\circ\text{C}$

MEM MEM100500

MEM, the minimum essential medium, contains only 12 essential amino acids, glutamine and 8 vitamins, and is suitable for the growth of a variety of cell monolayers. It can be widely used for the culture of various established cell lines and mammalian cell types in different places. MEM is suitable for cell culture work in some special research because it is easy to add or reduce certain components.

* [+] $\text{Earle's balanced salt}$ [+] 1.0 g/L Glucose [+] 2.2 g/L NaHCO_3 [+] 3.0 g/L HEPEs [+] 2 mM L-Glutamine

* 500 mL/bottle , 20 bottles/carton

* Storage conditions: $2-8^\circ\text{C}$

IMDM IMD100500

The culture liquid contains selenium, additional amino acids and vitamins, sodium pyruvate and HEPEs, and contains potassium nitrate in place of ferric nitrate. IMDM is a liquid rich in nutrients that can promote the growth of mouse B lymphocytes, LPS-stimulated B cells, bone marrow hematopoietic cells, T cells and lymphoma cells, and can also be used for rapid proliferation of high density cells.

* [+] 4.5 g/L Glucose [+] 3.0 g/L NaHCO_3 [+] 3.0 g/L HEPEs [+] 2 mM L-Glutamine

* 500 mL/bottle , 20 bottles/carton

* Storage conditions: $2-8^\circ\text{C}$

McCoy's 5A MCS100500

It is mainly designed for the culture of sarcoma cells, and can support the growth of a variety of primary grafts (such as bone marrow, skin, lung and spleen, etc.). In addition to culture of general primary cells, it is mainly used for tissue biopsy culture, some lymphocyte cultures, and as the growth support of some difficult-to-culture cells, such as Jensen rat sarcoma fibroblasts, human lymphocytes, HT-29, BHL-100 and other epithelial cells.

* [+] Tryptone [+] 3.0 g/L Glucose [+] 2.2 g/L NaHCO_3 [+] 3.0 g/L HEPEs [+] 2 mM L-Glutamine

* Storage conditions: $2-8^\circ\text{C}$

* 500 mL/bottle , 24 bottles/carton

Insect Media

McCoy's 5A MCS100500 is mainly designed for the culture of sarcoma cells.

TC-100 TC-100500 is suitable for culturing most lepidopteran cell lines.

TC-100 TC-100500

This insect culture medium has a pH value of 6.0-6.4 and osmotic pressure of 345-380 mOsm/kg, and is suitable for culturing most lepidopteran cell lines.

* [+] 1.0 g/L Glucose [+] 0.5 g/L HEPEs [+] 0.35 g/L NaHCO_3 [+] 2 mM L-Glutamine

* Storage conditions: $2-8^\circ\text{C}$

* 500 mL/bottle , 24 bottles/carton

**Supplementary Reagents**

Jet Bio-Filtration provides a wide range of high quality supplementary cell culture reagents, including PBS buffer, pancreatin, double antibodies, etc., to meet the needs of daily experiments.

**PBS 1X PBS000001**

PBS (phosphate buffered saline, 0.01M) maintains the pH range (PH 7.2-7.4) required by tissues and cells, and is widely used in cell culture applications, such as washing cells, dilution of cells and preparation of reagents during cell counting, etc.

Main ingredients: 3.49 g/L $\text{Na}_2\text{HPO}_4 \cdot 12\text{H}_2\text{O}$; 0.2 g/L KH_2PO_4 ; 0.2 g/L KCl

* [-] Calcium [-] Magnesium [-] Phenol Red

* Storage conditions: $2-8^\circ\text{C}$

Pancreatin PCT000500 /PCT000100

It is widely used for dissociation of tissues and monolayer cells.

* 0.25% Trypsin- 0.02% EDTA

* Storage conditions: -20°C

Double antibiotic (penicillin-streptomycin mixture) 100X/500X

* 100 mL , double antibiotic (penicillin-streptomycin mixture) 100X

* 500 mL , double antibiotic (penicillin-streptomycin mixture) 500X

* Storage conditions: -20°C

Cat. No.	Description	Package
PBS000001	PBS 1X, Storage conditions: $2-8^\circ\text{C}$	500 mL/bottle , 20 bottles/carton
PCT000500	Trypsin-EDTA (0.25%, calcium/magnesium-free, phenol red), Storage conditions: -20°C	500 mL/bottle , 20 bottles/carton
PCT100500	Trypsin (EDTA-free, calcium/magnesium-free, phenol red), Storage conditions: -20°C	500 mL/bottle , 20 bottles/carton
PCT000100	Trypsin-EDTA (0.25%, calcium/magnesium-free, phenol red) Storage conditions: -20°C	100 mL/bottle , 30 bottles/carton
DAB000100	100 mL , double antibody (penicillin-streptomycin mixture) 100X, Storage conditions: -20°C	15 PCs/box, 30 PCs/carton
DAB000500	500 mL , double antibody (penicillin-streptomycin mixture) 500X, Storage conditions: -20°C	20 PCs/carton



Stock Code: 688026

Laboratory Instruments



JET BIOFIL laboratory provides laboratory instruments and equipment includes laboratory water systems (Puro, Geno, Alto, and Pico), CO₂ incubators, microcentrifuges, mixers, magnetic stirrers, multifunctional shakers, automated nucleic acid extraction workstations, biosafety cabinets, etc.

	 Mini Centrifuge M1006	 The Smart Personal Centrifuge M1008	 Doctor Centrifuge with Microprocessor & Brushless Motor D1006
Centrifuge series	 High Speed Micro Centrifuge with Microprocessor & Brushless Motor D1018	 High Speed Micro Centrifuge with Microprocessor & Brushless Motor D1012	 Doctor Centrifuge with Microprocessor & Brushless Motor M1003S
	 The Table Top Genius with Microprocessor & Brushless Motor M1012P	 High-Speed Micro (Freezing) Centrifuge D1016R	 Desktop High-Speed Microcentrifuge D1016
	 Digital 3D Shaker with Microprocessor & Brushless Motor SK 3D-5	 4-Plate Shaker (up to 4 Microplates) SK Quattro	 30 mm-70 mm Diameter, Orbital / Linear motion SK 15
Shakers	 10 mm / 20 mm Diameter, Orbital / Linear motion SK 10/SK 20	 Microwell Plate Shaker SK18M	
Mixers	 Blood Tube Rotator DR 16	 Digital Multi-Tube Vortexer with Microprocessor & Brushless Motor VM25 D	 Digital Vortex Mixer with Microprocessor & Brushless Motor VM 42 D

Mixers



Digital Vortex Mixer with Microprocessor & Brushless Motor VM 28



Fixed Speed Blood Roller Mixer TR 4D

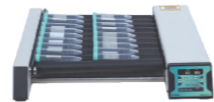

Digital Tube Roller with Microprocessor & Brushless Motor TR 6D/TR 10D



Mini Vortex Mixer with Brushless Motor VM 45MVM 45



Blood Tube Rotator DR 24



Digital Bottle Roller TR3D/TR5D

Micro Pipettes



JetPip™ Plus



Dispenser



JetPip™ Pipette Controller



Micro Volume Pipettes



Multichannel Micro Pipettes

Stirrer series



5 / 10 / 15 Station Heated Magnetic Stirrer with Microprocessor & Brushless Motor MS HP5M/MS HP10M/MS HP15M



Multistation Motorless Ultra Thin Magnetic Stirrer MS 5M/MS 10M/MS 15M



Motorless Slim Magnetic Stirrer MS Uno

Stirrer series



Multistation Motorless Ultra Thin Magnetic Stirrer MS 4M



Magnetic stirrer MS 2SL/MS 50L/MS-200L



Hot Plate Magnetic Stirrer MS HP550D



Hot Plate Magnetic Stirrer MS HP320D

Laboratory Water



Pure Water For Your Laboratory-Pico



Alto Ultrapure Type (I) Water



Puro Primary Grade Type (III) Water



Duo Dual Quality Type II and Type I Water



Geno Laboratory Grade Type (II) Water

Cell@ 188 CO₂ Incubator



CO₂ Incubator

FASTER



biosafety cabinet

JetPip™ Plus

Features

- Intuitive and convenient speed adjustment simply done with the tips of your fingers
- Lightweight, well-balanced and ergonomic design that allows for fatigue-free pipetting
- Vibrant backlit LEDs provide optical feedback of the remaining battery life and speed settings
- Rechargeable lithium polymer battery offers long cordless runtime
- Smooth setting of pump speed
- Operation while recharging is possible
- Compatible with most plastic and glass pipettes from 0.1-100mL
- Powerful pump fills a 25mL pipette in <5 seconds
- Quick release of aspirating cone for easy exchange of membrane filters



Cat. No.	Voltage	Charger Type	Qty.Per Box
SPA410220	Universal	0.1-100mL	1

JetPip™ Pipette Controller

Pipette controllers are highly technical and precise assistive devices for common 1 to 100 ml plastic or glass pipets.

Features

- Light weight and cordless for convenient use. If handled correctly, the device itself will not come into contact with any liquid.
- The aspirating or dispensing speed of the pump can be controlled by the pump speed switch.
- Made with recyclable materials.
- Long life and environmentally friendly with up to 8 hours rechargeable continuous electric power.
- The filter with hydrophobic membrane provides contamination-free liquid handling.



Pipette Controller

Cat. No.	Voltage	Charger Type	Qty.Per Box
SPA001220	Universal	1.0-100.0 mL	1
SPA003220		1.0-100.0 mL	1
SPA004220		1.0-100.0 mL	1

Fittings

Cat. No.	Name	Charger Type	Qty.Per Box
SPA010020	Filter (0.20 µm hydrophobic membrane)	----	5
SPA010045	Filter (0.45 µm hydrophobic membrane)	----	5
SPA020220	Charger	USA	1
SPA030220	Charger	UK	1
SPA040220	Charger	EU	1

Multichannel Micro Pipettes

Features

- Soft, smart TPE fingergrip
- Easily removable & fully autoclavable manifold
- Manifold rotates 360° for easy right or left hand operation
- One-hand tip ejection
- Consistent sample loading
- Soft tip loading and ejection
- Leak-free sealing of tip
- Attractive color coding
- Compatible with most types of tips
- Calibration report enclosed with every pipette



8 Channel Micro Pipettes								
Cat. No.	Range (µL)	Increment (µL)	Measurement Volume (µL)	Accuracy		Precision		
				%	µL	%	µL	
SPA008050	5-50	0.5	50	1	0.5	0.7	0.35	
			25	1.50	0.375	1	0.5	
			5	3.00	0.15	2	0.1	
SPA008100	10-100	1	100	1.00	1	0.5	0.5	
			50	1.00	0.5	0.5	0.25	
			10	1.50	0.15	0.75	0.075	
SPA008200	20-200	1	200	0.70	1.4	0.25	0.5	
			100	1.00	1.0	0.4	0.4	
			20	1.50	0.3	0.75	0.15	
SPA008300	30-300	1	300	0.80	2.4	0.25	0.75	
			150	1.00	1.5	0.50	0.75	
			50	1.50	0.75	0.75	0.375	

12-Channel Micro Pipettes							
Cat. No.	Range (µL)	Increment (µL)	Measurement Volume (µL)	Accuracy		Precision	
				%	µL	%	µL
SPA012010	0.5-10	0.1	10	1.5	0.15	1.5	1.5
			5	2.5	0.125	2.5	0.125
			1	4	0.4	4	0.4
SPA012050	5-50	0.5	50	1	0.5	0.7	0.7
			25	1.5	0.375	1	0.25
			5	3	0.15	2	0.1
SPA012100	10-100	1	100	1.00	1	0.50	0.5
			50	1.00	0.5	0.50	0.25
			10	1.50	0.15	0.75	0.75
SPA012200	20-200	1	200	0.7	1.4	0.25	0.5
			100	1	1	0.4	0.4
			20	1.5	0.3	0.75	0.15
SPA012300	30-300	1	300	0.80	2.4	0.25	0.75
			150	1.00	1.5	0.50	0.75
			50	1.50	0.75	0.75	0.375

Variable Volume Pipette							
Cat. No.	Range (µL)	Increment (µL)	Measurement Volume (µL)	Accuracy		Precision	
				%	µL	%	µL
SPA200125	0.1-2.5	0.01	2.5	2.50	0.0625	1.60	0.04
			1.25	3.00	0.0375	3.00	0.0375
			0.25	12.00	0.03	6.00	0.015
SPA200510	0.5-10	0.1	10	1.00	0.1	0.80	0.08
			5	2.00	0.1	1.00	0.05
			1	2.50	0.025	1.50	0.015
SPA200220	2-20	0.5	20	0.90	0.18	0.40	0.08
			10	1.50	0.15	1.00	0.1
			2	3.00	0.06	2.00	0.04
SPA200550	5-50	1	50	0.60	0.3	0.30	0.15
			25	0.80	0.2	0.40	0.1
			5	2.00	0.1	2.00	0.1
SPA210100	10-100	0.5	100	0.80	0.8	0.15	0.15
			50	1.00	0.5	0.50	0.25
			10	3.00	0.3	1.50	0.15
SPA220200	20-200	1	200	0.60	1.2	0.15	0.3
			100	0.70	0.7	0.30	0.3
			20	2.00	0.4	0.80	0.16
SPA211000	100-1000	5	1000	0.60	6	0.20	2
			500	1.00	5	0.40	2
			100	2.00	2	0.70	0.7

Micro Volume Pipettes

Features

- Suitable for both left and right handed users, and offers a relaxed grip and good balance
- Light & smooth plunger action
- Fully autoclavable
- UV resistant
- Resistance-free click-stop counter
- Larger digits
- Ergonomic design ensuring light weight & soft plunger movement
- Easily accessible recalibration mechanism without any chance of accidental change in calibration
- Calibration conforms to DIN 12650 & EN-ISO 8655 standards, ensuring high accuracy & precision



Fixed Volume Pipette							
Cat. No.	Range (µL)	Increment (µL)	Measurement Volume (µL)	Accuracy		Precision	
				%	µL	%	µL
SPA100005	5	-	5	1.3	0.065	1.2	0.06
SPA100010	10	-	10	0.8	0.08	0.8	0.08
SPA100050	50	-	50	0.5	0.25	0.3	0.15
SPA100100	100	-	100	0.5	0.5	0.3	0.3
SPA100500	500	-	500	0.3	1.5	0.2	1.0
SPA101000	1000	-	1000	0.3	3.0	0.15	1.5

